

SMAJ-HRA Series

Surface Mount - 400W



Agency Approvals

Agency	Agency File/Certificate Number
	E230531

Maximum Ratings & Thermal Characteristics

($T_A = 25^\circ\text{C}$ unless otherwise noted)

Parameter	Symbol	Value	Unit
Peak Pulse Power Dissipation ($I_{PP} \times V_C$) by 10/1000 μs Waveform (Fig.2) (Note 1), (Note 2)	P_{PPM}	400	W
Power Dissipation on Infinite Heat Sink at $T_J = 50^\circ\text{C}$	P_D	3.3	W
Peak Forward Surge Current, 8.3ms Single Half Sine Wave (Note 3)	I_{FSM}	60	A
Maximum Instantaneous Forward Voltage at 25A for Unidirectional Only	V_F	3.5	V
Operating Temperature Range	T_J	-65 to 150	$^\circ\text{C}$
Storage Temperature Range	T_{STG}	-65 to 175	$^\circ\text{C}$
Typical Thermal Resistance Junction to Lead	$R_{\theta JL}$	30	$^\circ\text{C/W}$
Typical Thermal Resistance Junction to Ambient	$R_{\theta JA}$	120	$^\circ\text{C/W}$

Notes:

1. Non-repetitive current pulse, per Fig. 4 and derated above T_J (initial) $= 25^\circ\text{C}$ per Fig. 3.
2. Mounted on copper pad area of 0.31x0.31" (8.0 x 8.0mm) to each terminal.
3. Measured on 8.3ms single half sine wave or equivalent square wave for unidirectional component only

Functional Diagram

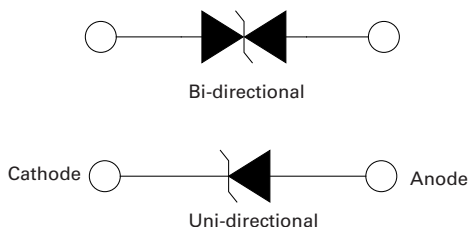

Description

The SMAJ-HRA High Reliability series is designed specifically to protect sensitive electronic equipment from voltage transients induced by lightning and other transient voltage events.

Features

- Excellent clamping capability
- Typical $I_R \leq 1\mu\text{A}$ for $V_R > 10\text{V}$
- For surface mounted applications to optimize board space
- Low profile package
- Typical failure mode is short from over-specified voltage or current
- Whisker test is conducted based on JEDEC JESD201A per its table 4a and 4c
- ESD protection of data lines in accordance with IEC 61000-4-2, 30kV(Air), 30kV (Contact)
- EFT protection of data lines in accordance with IEC 61000-4-4
- Built-in strain relief
- 400W Peak pulse power capability at 10/1000 μs waveform, repetition rate (duty cycle): 0.01%
- Fast response time: typically less than 1.0ps from 0 Volts to $V_{BR \text{ min}}$
- Glass passivated junction
- Low inductance
- High temperature to reflow soldering guaranteed: $260^\circ\text{C}/40\text{sec}$
- $V_{BR} @ T_J = V_{BR} @ 25^\circ\text{C} \times (1 + \alpha T \times (T_J - 25))$ (α : Temperature Coefficient, typical value is 0.1%) Coefficient, typical value
- UL Recognized epoxy meeting flammability rating V-0
- Meet MSL level1, per J-STD-020, LF maximum peak of 260°C
- Matte tin lead-free Plated
- Halogen free and RoHS compliant
- Pb-free E3 means 2nd level interconnect is Pb-free and the terminal finish material is tin(Sn) (IPC/JEDEC J-STD-609A.01)

Applications

TVS Components are ideal for the protection of I/O Interfaces, V_{CC} bus and other vulnerable circuits used in Telecom, Computer, Industrial and Consumer electronic applications.



SMAJ-HRA Series

Surface Mount - 400W

Electrical Characteristics

Part Number (Uni)	Part Number (Bi)	Marking		Reverse Stand off Voltage V_R (Volts)	Breakdown Voltage V_{BR} (Volts) @ I_T		Test Current I_T (mA)	Maximum Clamping Voltage V_C @ I_{PP} (V)	Maximum Peak Pulse Current I_{PP} (A)	Maximum Reverse Leakage I_R @ V_R (μ A)	Agency Approval 
		UNI	BI		MIN	MAX					
SMAJ6.0A-HRA	SMAJ6.0CA-HRA	AGH	WGH	6.0	6.67	7.37	10	10.3	38.8	800	X
SMAJ9.0A-HRA	SMAJ9.0CA-HRA	AVH	WVH	9.0	10.00	11.10	1	15.4	26.0	10	X
SMAJ10A-HRA	SMAJ10CA-HRA	AXH	WXH	10.0	11.10	12.30	1	17.0	23.5	5	X
SMAJ11A-HRA	SMAJ11CA-HRA	AZH	WZH	11.0	12.20	13.50	1	18.2	22.0	1	X
SMAJ12A-HRA	SMAJ12CA-HRA	BEH	XEH	12.0	13.30	14.70	1	19.9	20.1	1	X
SMAJ13A-HRA	SMAJ13CA-HRA	BGH	XGH	13.0	14.40	15.90	1	21.5	18.6	1	X
SMAJ14A-HRA	SMAJ14CA-HRA	BKH	XKH	14.0	15.60	17.20	1	23.2	17.2	1	X
SMAJ15A-HRA	SMAJ15CA-HRA	BMH	XMH	15.0	16.70	18.50	1	24.4	16.4	1	X
SMAJ16A-HRA	SMAJ16CA-HRA	BPH	XPH	16.0	17.80	19.70	1	26.0	15.4	1	X
SMAJ17A-HRA	SMAJ17CA-HRA	BRH	XRH	17.0	18.90	20.90	1	27.6	14.5	1	X
SMAJ18A-HRA	SMAJ18CA-HRA	BTH	XTH	18.0	20.00	22.10	1	29.2	13.7	1	X
SMAJ20A-HRA	SMAJ20CA-HRA	BVH	XVH	20.0	22.20	24.50	1	32.4	12.3	1	X
SMAJ26A-HRA	SMAJ26CA-HRA	CEH	YEH	26.0	28.90	31.90	1	42.1	9.5	1	X
SMAJ33A-HRA	SMAJ33CA-HRA	CMH	YMH	33.0	36.70	40.60	1	53.3	7.5	1	X
SMAJ36A-HRA	SMAJ36CA-HRA	CPH	YPH	36.0	40.00	44.20	1	58.1	6.9	1	X
SMAJ45A-HRA	SMAJ45CA-HRA	CVH	YVH	45.0	50.00	55.30	1	72.7	5.5	1	X

Note:

1. For bidirectional type having V_R of 10 volts and less, the I_R limit is double.

SMAJ-HRA Series

Surface Mount - 400W

Screen Process

100% Vision Inspection	MIL-STD-750 method 2074
100% High Temperature Storage Life (168hrs,175°C)	MIL-STD-750 method 1031
100% X-RAY inspection	MIL-STD-750 method 2076
100% Temperature Cycle Test (-55 to 150°C, 20 cycles, dwell time 15 min)	MIL-STD-750 method 1051
100% Reflow (2X)	JEDEC J-STD-020
100% Surge Test (2x)	MIL-STD-750 method 4066
100% HTRB 150°C Bias=V_R (80% breakdown voltage, 96hrs, and each direction 96hrs for Bi-directional products)	MIL-STD-750 method 1038
Final Electrical Test (100% 3 sigma limit, 100% dynamic test and PAT limit)	MIL-STD-750 method 4016.4021.4011

Note: Up-screen program can be specified by customer's request by contacting Littelfuse customer service

I-V Curve Characteristics

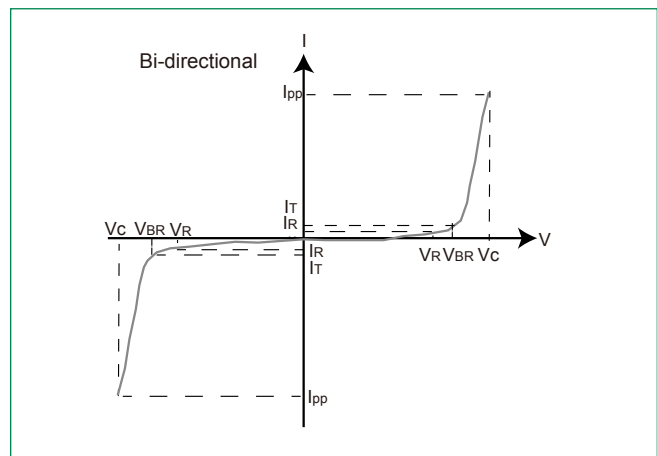
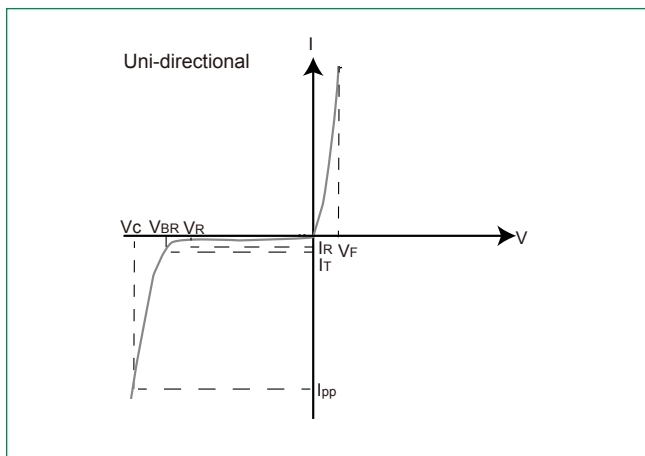

- P_{PPM} Peak Pulse Power Dissipation** -- $(I_{pp} \times V_C)$ Max power dissipation
 V_R Stand-off Voltage -- Maximum voltage that can be applied to the TVS without operation
 V_{BR} Breakdown Voltage -- Maximum voltage that flows through the TVS at a specified test current (I_T)
 V_C Clamping Voltage -- Peak voltage measured across the TVS at a specified I_{ppm} (peak impulse current)
 I_R Reverse Leakage Current -- Current measured at V_R
 V_F Forward Voltage Drop for Uni-directional

SMAJ-HRA Series

Surface Mount - 400W

Ratings and Characteristic Curves ($T_A=25^\circ\text{C}$ unless otherwise noted)

Figure 1 - TVS Transients Clamping Waveform

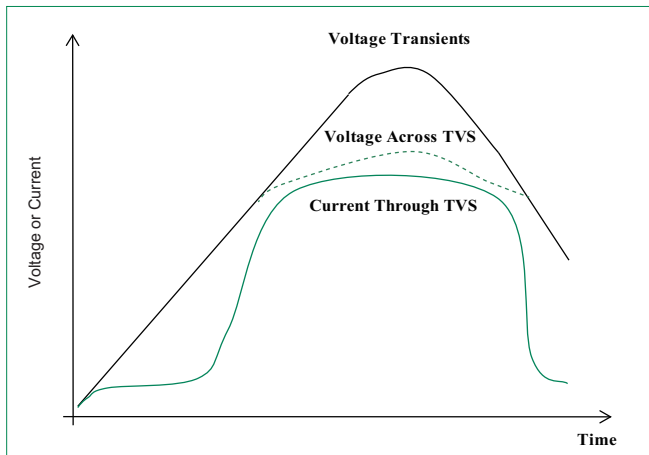

Figure 2 - P_{PPM} Peak Pulse Power Rating Curve

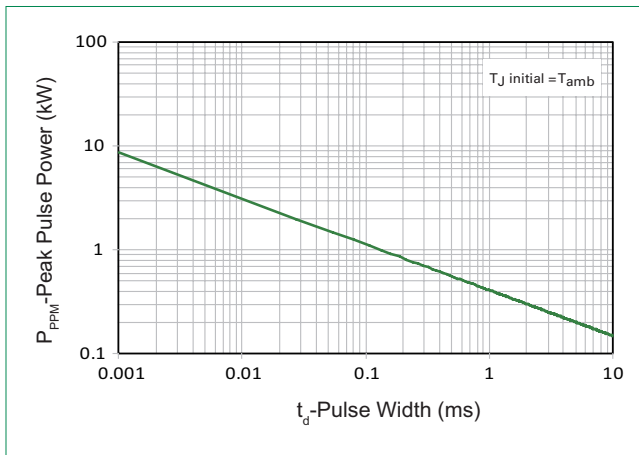

Figure 3 - Peak Pulse Power Derating Curve

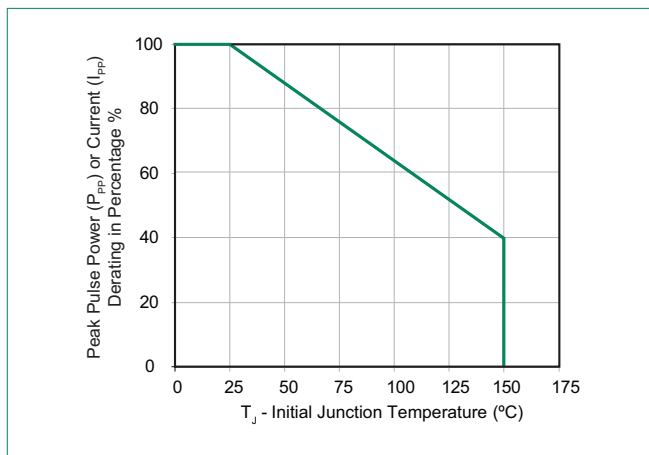

Figure 4 - Pulse Waveform

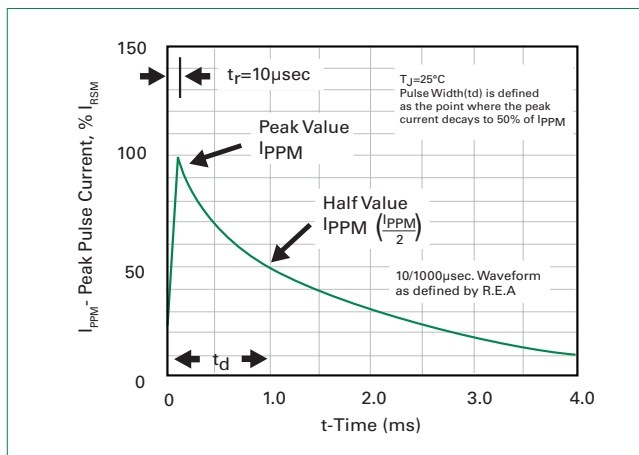

Figure 5 - Typical Junction Capacitance

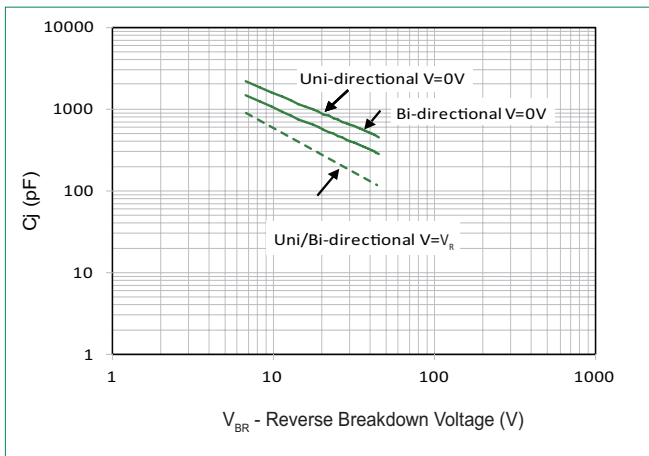
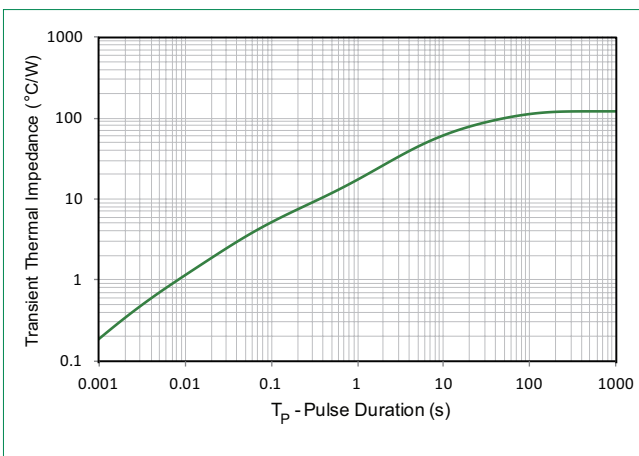

Figure 6 - Typical Transient Thermal Impedance



SMAJ-HRA Series

Surface Mount - 400V

Figure 7 - Maximum Non-Repetitive Forward Surge Current Uni-Directional Only

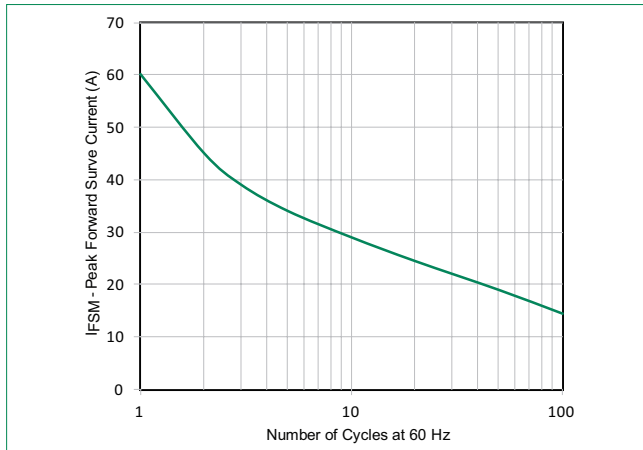
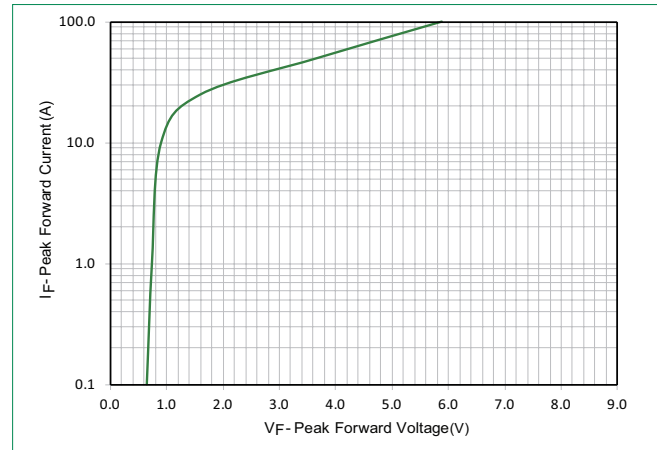
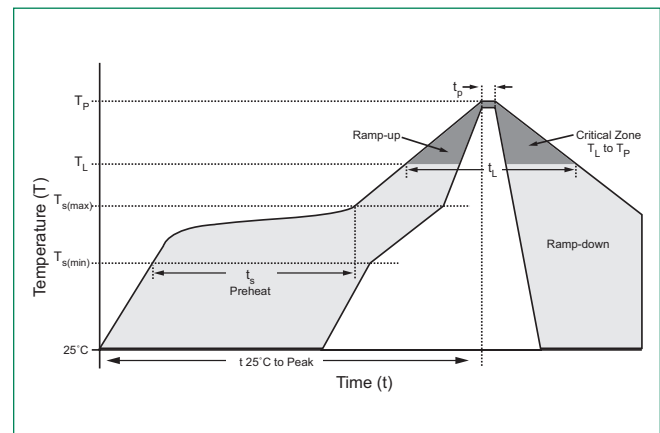

Figure 8 - Peak Forward Voltage Drop vs Peak Forward Current (Typical Values)



Soldering Parameters

Reflow Condition	Lead-free assembly	
Pre Heat	- Temperature Min ($T_{s(min)}$)	150°C
	- Temperature Max ($T_{s(max)}$)	200°C
	- Time (min to max) (t_s)	60 – 120 secs
Average ramp up rate (Liquidus Temp (T_L) to peak)	3°C/second max	
$T_{s(max)}$ to T_L - Ramp-up Rate	3°C/second max	
Reflow	- Temperature (T_L) (Liquidus)	217°C
	- Time (min to max) (t_s)	60 – 150 seconds
Peak Temperature (T_p)	260 ^{+0/-5} °C	
Time within 5°C of actual peak Temperature (t_p)	30 seconds	
Ramp-down Rate	6°C/second max	
Time 25°C to peak Temperature (T_p)	8 minutes max.	
Do not exceed	260°C	



Physical Specifications

Weight	0.002 ounce, 0.061 gram
Case	JEDEC DO-214AC Molded Plastic over glass passivated junction
Polarity	Color band denotes cathode except bidirectional
Terminal	Matte Tin-plated leads. Solderable per JESD22-B102

Environmental Specifications

High Temp. Storage	JESD22-A103
HTRB	JESD22-A108
Temperature Cycling	JESD22-A104
MSL	JEDEC-J-STD-020, Level 1
H3TRB	JESD22-A101
RSH	JESD22-A111

Part Numbering System

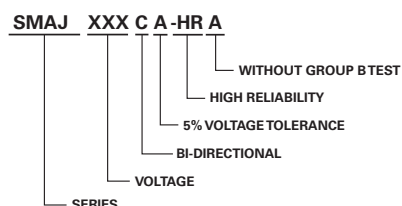

Part Marking System

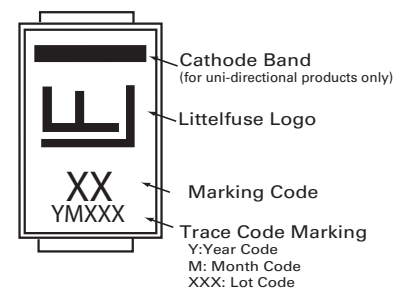

SMAJ-HRA Series

Surface Mount - 400W

Dimensions

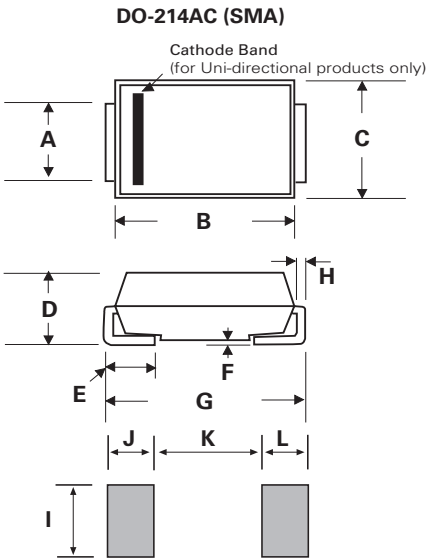

Dimensions	Inches		Millimeters	
	Min	Max	Min	Max
A	0.049	0.065	1.250	1.650
B	0.157	0.181	3.990	4.600
C	0.095	0.110	2.400	2.790
D	0.075	0.090	1.900	2.290
E	0.030	0.060	0.780	1.520
F	-	0.008	-	0.203
G	0.189	0.208	4.800	5.280
H	0.006	0.012	0.152	0.305
I	0.070	-	1.800	-
J	0.082	-	2.100	-
K	-	0.090	-	2.300
L	0.082	-	2.100	-

Packaging

Part number	Component Package	Quantity	Packaging Option	Packaging Specification
SMAJ-xxxXX-HRA	DO-214AC	5000	Tape & Reel - 12mm tape/13" reel	EIA STD RS-481

Tape and Reel Specification

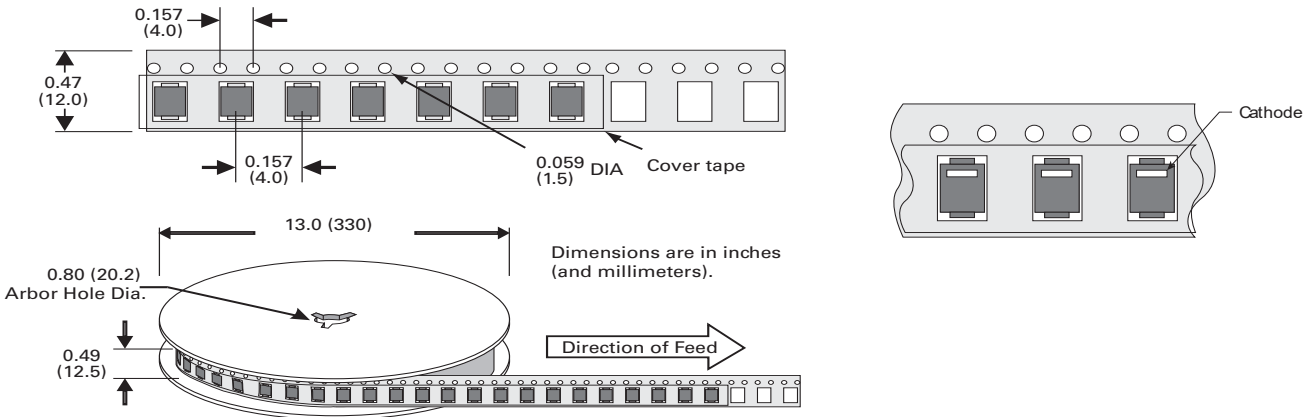

Disclaimer Notice - Information furnished is believed to be accurate and reliable. However, users should independently evaluate the suitability of and test each product selected for their own applications. Littelfuse products are not designed for, and may not be used in, all applications. Read complete Disclaimer Notice at <http://www.littelfuse.com/disclaimer-electronics>.