

55110 Miniature Flange Mounting Proximity Sensor

RoHS

OBSOLETE DATE: 06/23/2021 PCN/ECN# _____
REPLACED BY: _____



Description

The 55110 is a flange mounting hall effect sensor with the integral LED for visual indication of operation. The overall sensor measures 34.00m (1.339") x 14.00m (0.551") x 10.00mm (0.394"). It is available as three-wire (voltage output) version and its case design enables screw or adhesive mounting. It is capable of switching up to 28Vdc and 20mA. It works best with Littelfuse's H-58 magnet.

Features

- Magnetically operated position sensor
- Integral LED
- Medium or high sensitivities
- Three-wire (voltage output)
- Reverse/Over voltage protection
- Built in temperature compensation

Dimensions

Dimensions in mm (inch)

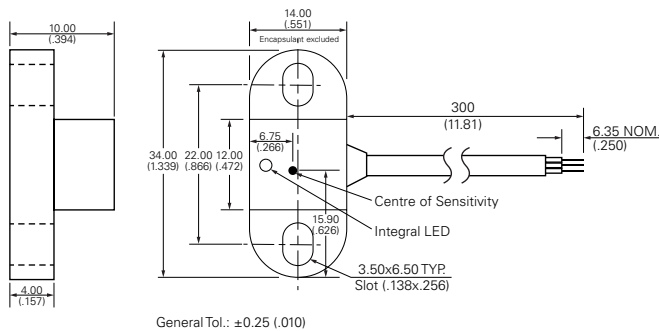

Benefits

- High switching speed up to 10kHz
- Long life - up to 1 billion operations
- Visual indication of operation
- Unaffected by harsh environments
- Operates in static or dynamic magnetic field
- Customer selection of cable length and connector type

Applications

- Position and limit sensing
- Magnetic encoders

Block Diagram

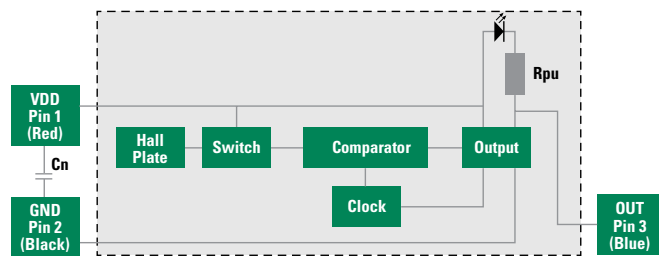

Note:

1. Add capacitor Cn as shown, close for the sensors for transient suppression if required.

55110 Miniature Flange Mounting Proximity Sensor

Electrical Ratings

Hall Type	Absolute Ratings Operate Overvoltage Protection	Vdc Vdc Vdc - max.	Digital Switch Three-Wire (Voltage Output)
Supply Voltage ¹			-15 to +28 +3.8 to +24 32
Output High Voltage		Vdc - min.	Vdd-2 @ 0.1mA (sinking output with internal pull-up)
Output Low Voltage		Vdc - max.	0.4 @ 10mA
Output Current (continuously on)		mA - max.	10
Switching Speed		Khz - max.	10
Temperature	Operating	°C	-40 to +85

Note:

1. As long as Tj (Junction Temperature) max. Is not exceeded.

Hall Options

Select Option	Hall Type	Sensitivity Gauss (typ.)	Activate - D mm (inch)
3M	3 Wire Switch	130	12.5 (.492)
3H	3 Wire Switch	59	18.0 (709)

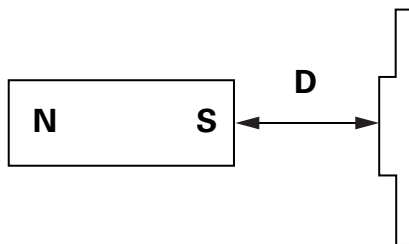



Note: Active distances are approximate using NEFEB Magnet 21 x 7 x 4.7 (.8271 x .276W x .185H) LITTELFUSE P/N H-58-MAGNET.

55110 Miniature Flange Mounting Proximity Sensor

Cable Length Specification

Cable Type: 24AWG 7/32/PVC 105°C Double Insulated	
Select Option	Cable Length mm (inch)
02	300 (11.81)

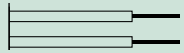
Termination Specification

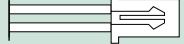
Termination Options		
Select Option	Description (Two-wire versions illustrated)	
A	Tinned leads (6.4±0.76)mm	
F	Untinned leads (6.4±0.76)mm	
E	JST type XHP 2.5mm pitch	

Part Numbering System

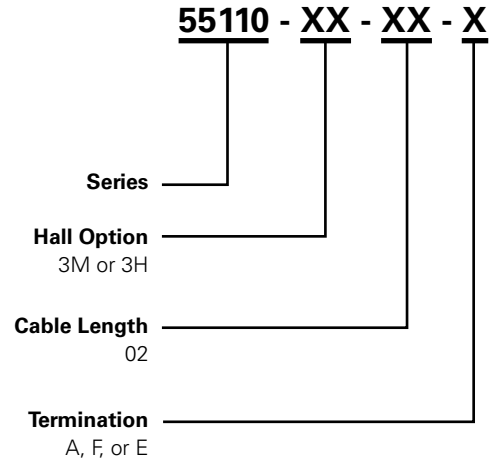

Packaging

Packaging Option	Packaging Specification	Quantity	Quantity & Packaging Code	Taping Width
Bulk	Bulk	500	N/A	N/A