

MAC12SM, MAC12SN

TRIACS 600V - 800V

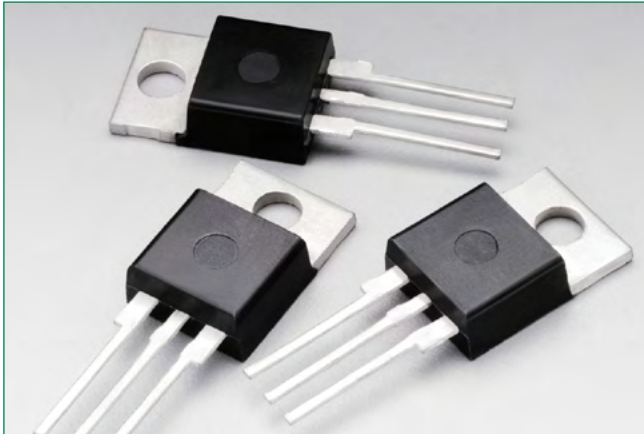

Additional Information



Resources



Accessories



Samples

Description

Designed for industrial and consumer applications for full wave control of AC loads such as appliance controls, heater controls, motor controls, and other power switching applications.

Features

- Sensitive Gate Allows Triggering by Microcontrollers and other
- Logic Circuits
- Blocking Voltage to 800 Volts
- On-State Current Rating of 12 Amperes RMS at 70°C
- High Surge Current Capability – 90 Amperes
- Rugged, Economical TO-220AB Package
- Glass Passivated Junctions for Reliability and Uniformity
- Maximum Values of IGT, VGT and IH Specified for Ease of Design
- High Commutating di/dt – 8.0 A/ms Minimum at 110°C
- Immunity to dV/dt – 15 V/sec Minimum at 110°C
- Operational in Three Quadrants: Q1, Q2, and Q3
- These Devices are Pb-Free and are RoHS Compliant*

*RoHS-compliant and lead-free

Pin Out

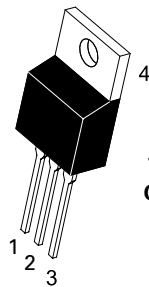

TO-220AB
CASE 221A
STYLE 4

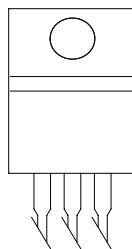

Functional Diagram

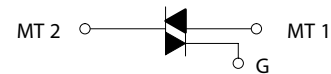

MAC12SM, MAC12SN

TRIACS 600V - 800V

Maximum Ratings ($T_J = 25^\circ\text{C}$ unless otherwise noted)

Rating	Symbol	Value	Unit
Peak Repetitive Off-State Voltage (Note 1) (Gate Open, Sine Wave 50 to 60 Hz, $T_J = 40$ to 110°C)	MAC12SM V_{DRM} MAC12SN V_{RRM}	600 800	V
On-State RMS Current (Full Cycle Sine Wave, 60 Hz, $T_C = 70^\circ\text{C}$)	$I_{T(RMS)}$	12	A
Peak Non-Repetitive Surge Current (One Full Cycle Sine Wave, 60 Hz, $T_J = 110^\circ\text{C}$)	I_{TSM}	100	A
Circuit Fusing Consideration ($t = 8.3$ ms)	I^2t	33	A ² sec
Peak Gate Power (Pulse Width ≤ 1.0 μs , $T_C = 70^\circ\text{C}$)	P_{GM}	16	W
Average Gate Power ($t = 8.3$ ms, $T_C = 70^\circ\text{C}$)	$P_{G(AV)}$	0.35	W
Operating Junction Temperature Range	T_J	-40 to +110	$^\circ\text{C}$
Storage Temperature Range	T_{stg}	-40 to +150	$^\circ\text{C}$

Stresses exceeding Maximum Ratings may damage the device. Maximum Ratings are stress ratings only. Functional operation above the Recommended Operating Conditions is not implied. Extended exposure to stresses above the Recommended Operating Conditions may affect device reliability.

1. V_{DRM} and V_{RRM} for all types can be applied on a continuous basis. Ratings apply for zero or negative gate voltage; however, positive gate voltage shall not be applied concurrent with negative potential on the anode. Blocking voltages shall not be tested with a constant current source such that the voltage ratings of the devices are exceeded.

Thermal Characteristics

Rating	Symbol	Value	Unit
Thermal Resistance, Junction-to-Case (AC) Junction-to-Ambient	$R_{\theta JC}$ $R_{\theta JA}$	2.2 62.5	$^\circ\text{C}/\text{W}$
Maximum Lead Temperature for Soldering Purposes, 1/8" from case for 10 seconds	T_L	260	$^\circ\text{C}$

Electrical Characteristics - OFF ($T_J = 25^\circ\text{C}$ unless otherwise noted ; Electricals apply in both directions)

Characteristic	Symbol	Min	Typ	Max	Unit
Peak Repetitive Blocking Current ($V_D = V_{DRM} = V_{RRM}$; Gate Open)	I_{DRM} I_{RRM}	-	-	0.01	mA
		-	-	2.0	

Electrical Characteristics - ON ($T_J = 25^\circ\text{C}$ unless otherwise noted; Electricals apply in both directions)

Characteristic	Symbol	Min	Typ	Max	Unit
Peak On-State Voltage (Note 2) ($I_{TM} = \pm 17$ A)	V_{TM}	-	-	1.85	V
Gate Trigger Current (Continuous dc) ($V_D = 12$ V, $R_L = 100$ Ω)	MT2(+), G(+)	-	1.5	5.0	mA
	MT2(+), G(-)	-	2.5	5.0	
	MT2(-), G(-)	-	2.7	5.0	
Holding Current ($V_D = 12$ V, Gate Open, Initiating Current = ± 200 mA)	I_H	-	2.5	10	mA
Latching Current ($V_D = 12$ V, $I_G = 5$ mA)	MT2(+), G(+)	-	3.0	15	mA
	MT2(+), G(-)	-	5.0	20	
	MT2(-), G(-)	-	3.0	15	
Gate Trigger Voltage ($V_D = 12$ V, $R_L = 100$ Ω)	MT2(+), G(+)	0.45	0.68	1.5	V
	MT2(+), G(-)	0.45	0.62	1.5	
	MT2(-), G(-)	0.45	0.67	1.5	

Product parametric performance is indicated in the Electrical Characteristics for the listed test conditions, unless otherwise noted. Product performance may not be indicated by the Electrical Characteristics if operated under different conditions.

2. Indicates Pulse Test: Pulse Width ≤ 2.0 ms, Duty Cycle $\leq 2\%$.

MAC12SM, MAC12SN

TRIACS 600V - 800V

Dynamic Characteristics

Characteristic	Symbol	Min	Typ	Max	Unit
Critical Rate of Change of Commutating Current ($V_D = 400\text{ V}$, $I_{TM} = 3.5\text{ A}$, Commutating $dv/dt = 10\text{ V}/\mu\text{s}$, Gate Open, $T_J = 110\text{ }^\circ\text{C}$, $f = 500\text{ Hz}$, Snubber: $C_s = 0.01\text{ }\mu\text{F}$, $R_s = 15\text{ }\Omega$)	$(dv/dt)_C$	8.0	10	–	A/ms
Critical Rate of Rise of Off-State Voltage ($V_D = 67\% V_{DRM}$, Exponential Waveform, $R_{GK} = 1\text{ K}$, $T_J = 110\text{ }^\circ\text{C}$)	dV/dt	15	40	–	V/ μs
Repetitive Critical Rate of Rise of On-State Current IPK = 50 A; PW = 40 μsec ; $di/dt = 100\text{ mA}/\mu\text{sec}$; $I_{gt} = 100\text{ mA}$; $f = 60\text{ Hz}$	di/dt	–	–	10	A/ μs

Voltage Current Characteristic of SCR

Symbol	Parameter
V_{DRM}	Peak Repetitive Forward Off State Voltage
I_{DRM}	Peak Forward Blocking Current
V_{RRM}	Peak Repetitive Reverse Off State Voltage
I_{RRM}	Peak Reverse Blocking Current
V_{TM}	Maximum On State Voltage
I_H	Holding Current

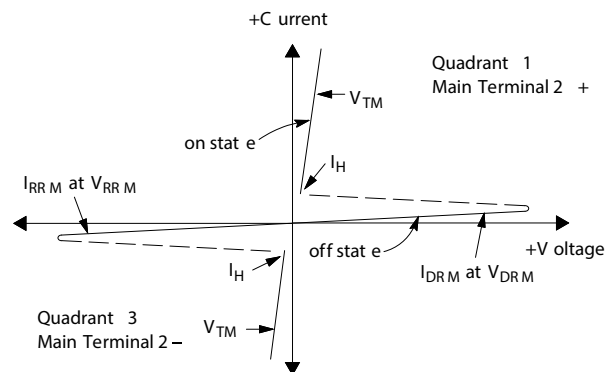

Quadrant Definitions for a Triac

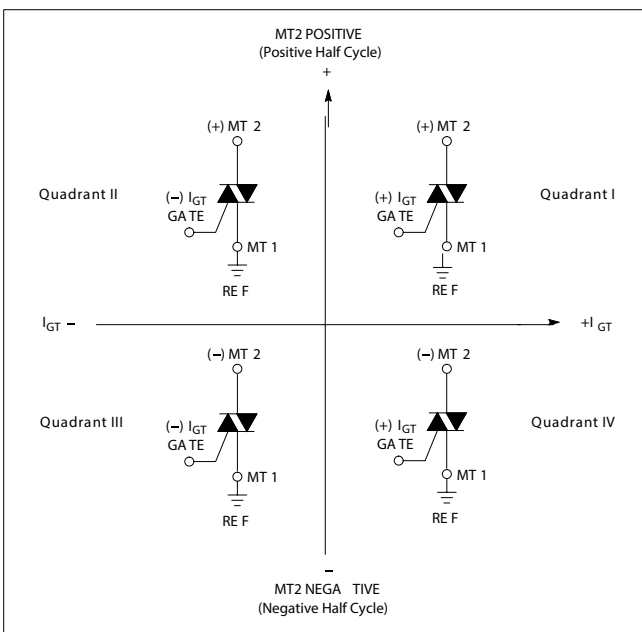

All polarities are referenced to MT1.
With in-phase signals (using standard AC lines) quadrants I and III are used

MAC12SM, MAC12SN

TRIACS 600V - 800V

Figure 1.

Typical Gate Trigger Current vs Junction Temperature

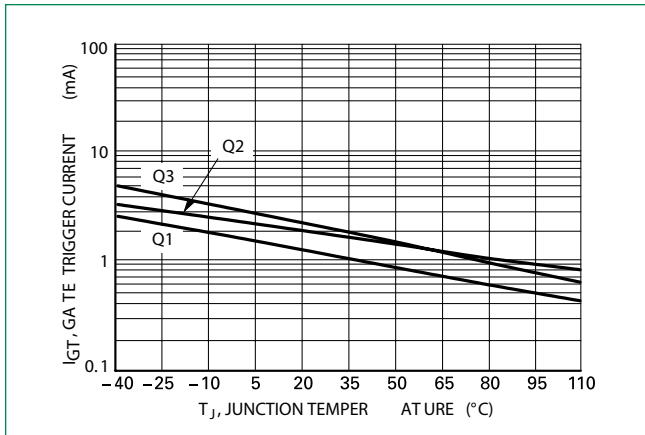

Figure 2.

Typical Gate Trigger Voltage vs Junction Temperature

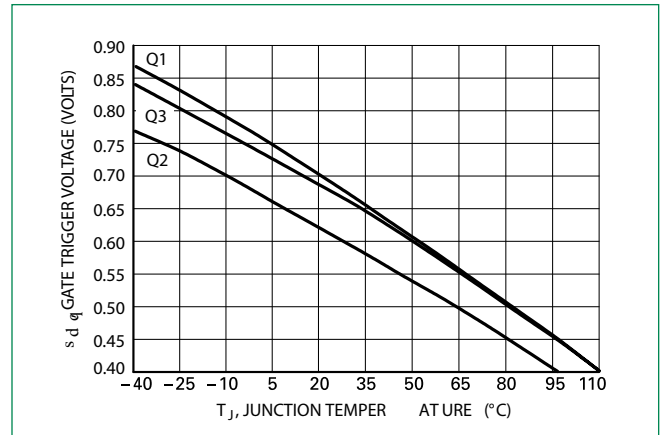

Figure 3.

Typical Holding Current vs Junction Temperature

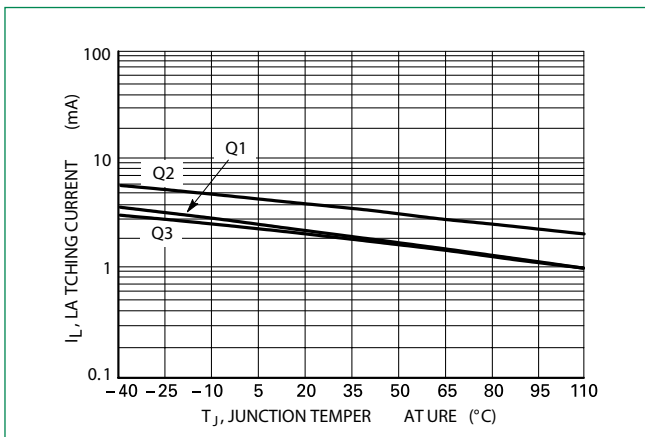

Figure 4.

Typical Latching Current vs Junction Temperature

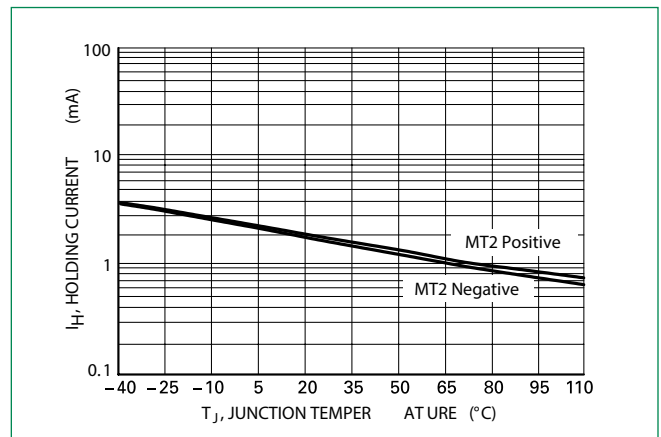

Figure 5.

Typical RMS Current Derating

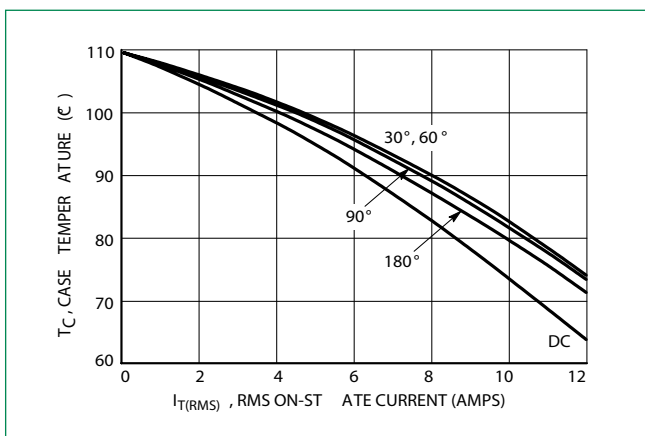
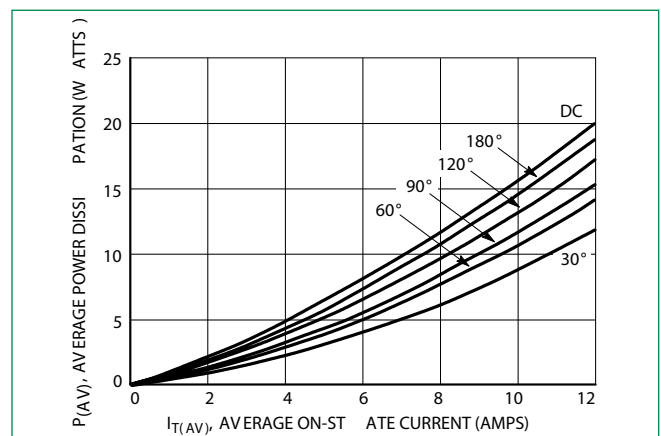

Figure 6.

On-State Power Dissipation



MAC12SM, MAC12SN

TRIACS 600V - 800V

Figure 7.
Typical On-State Characteristics

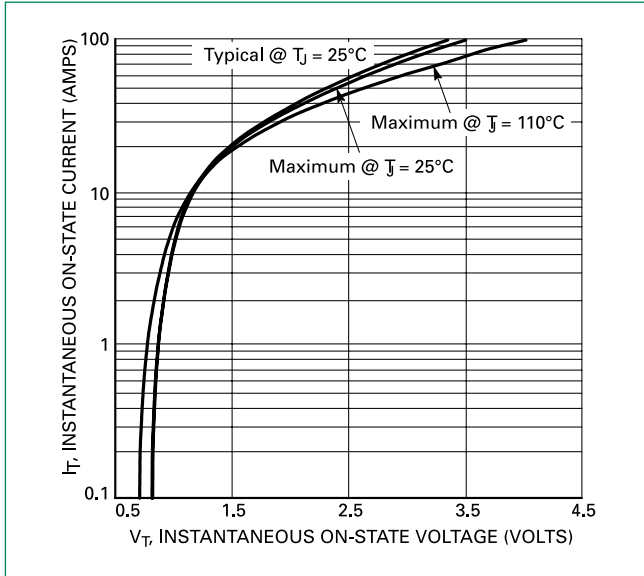
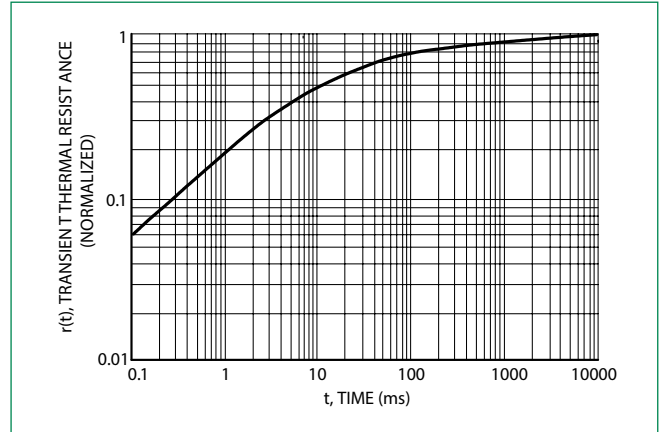

Figure 8.
Typical Thermal Response



MAC12SM, MAC12SN

TRIACS 600V - 800V

Dimensions

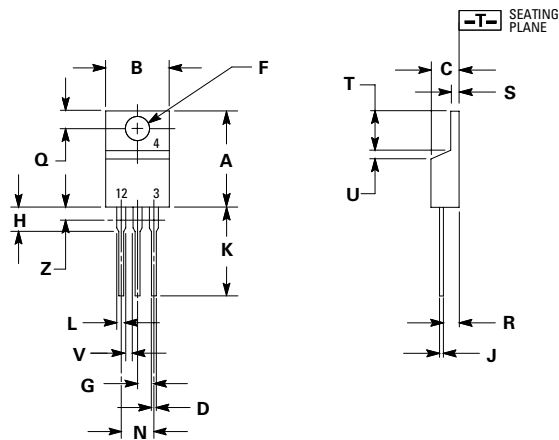

Part Marking System

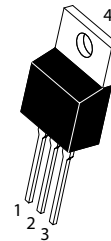

**TO-220AB
CASE 221A
STYLE 12**

x =M or N
Y =Year
M =Month
XXX =Lot Trace Code
G =Pb-Free Package

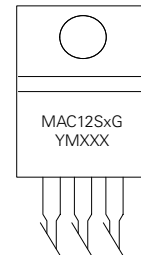

Dim	Inches		Millimeters	
	Min	Max	Min	Max
A	0.590	0.620	14.99	15.75
B	0.380	0.420	9.65	10.67
C	0.178	0.188	4.52	4.78
D	0.025	0.035	0.64	0.89
F	0.142	0.147	3.61	3.73
G	0.095	0.105	2.41	2.67
H	0.110	0.130	2.79	3.30
J	0.018	0.024	0.46	0.61
K	0.540	0.575	13.72	14.61
L	0.060	0.075	1.52	1.91
N	0.195	0.205	4.95	5.21
Q	0.105	0.115	2.67	2.92
R	0.085	0.095	2.16	2.41
S	0.045	0.060	1.14	1.52
T	0.235	0.255	5.97	6.47
U	0.000	0.050	0.00	1.27
V	0.045	---	1.15	---
Z	---	0.080	---	2.04

1. Dimensioning and tolerancing per ansi y14.5m, 1982.
2. Controlling dimension: inch.
3. Dimension z defines a zone where all body and lead irregularities are allowed.

Pin Assignment

Pin	Assignment
1	Main Terminal 1
2	Main Terminal 2
3	Gate
4	Main Terminal 2

Ordering Information

Device	Package	Shipping
MAC12SMG	TO-220AB (Pb-Free)	1000 Units / Box
MAC12SNG		

Disclaimer Notice - Information furnished is believed to be accurate and reliable. However, users should independently evaluate the suitability of and test each product selected for their own applications. Littelfuse products are not designed for, and may not be used in, all applications. Read complete Disclaimer Notice at <http://www.littelfuse.com/disclaimer-electronics>.