

Features

- High level of integration—only one power semiconductor module required for the whole drive
- Low saturation voltage and positive temperature coefficient
- Fast switching and short tail current
- Free wheeling diodes with fast and soft reverse recovery
- Industry standard package with insulated copper base plate and soldering pins for PCB mounting
- Temperature sense included

Applications

- AC motor control
- Motion/servo control
- Inverter and power supplies

Module Characteristics ($T_J = 25^\circ\text{C}$, unless otherwise specified)

Symbol	Parameters	Test Conditions	Min	Typ	Max	Unit
$T_{J(max)}$	Max. Junction Temperature				150	$^\circ\text{C}$
$T_{J(op)}$	Operating Temperature		-40		125	$^\circ\text{C}$
T_{stg}	Storage Temperature		-40		125	$^\circ\text{C}$
V_{isol}	Insulation Test Voltage	AC, t=1min		3000		V
CTI	Comparative Tracking Index		250			
M_d	Mounting Torque	Recommended (M5)	2.5		5	N·m
Weight				300		g

Absolute Maximum Ratings ($T_J = 25^\circ\text{C}$, unless otherwise specified)

Symbol	Parameters	Test Conditions	Values	Unit
IGBT				
V_{CES}	Collector - Emitter Voltage	$T_J=25^\circ\text{C}$	1200	V
V_{GES}	Gate - Emitter Voltage		± 20	V
I_C	DC Collector Current	$T_C=25^\circ\text{C}$	75	A
		$T_C=80^\circ\text{C}$	50	A
I_{CM}	Repetitive Peak Collector Current	$t_p=1\text{ms}$	100	A
P_{tot}	Power Dissipation Per IGBT		260	W
Diode				
V_{RRM}	Repetitive Reverse Voltage	$T_J=25^\circ\text{C}$	1200	V
$I_{F(AV)}$	Average Forward Current	$T_C=25^\circ\text{C}$	75	A
		$T_C=80^\circ\text{C}$	50	A
I_{FRM}	Repetitive Peak Forward Current	$t_p=1\text{ms}$	100	A
I^2t		$T_J=125^\circ\text{C}$, t=10ms, $V_R=0\text{V}$	680	A^2s

Electrical and Thermal Specifications ($T_J = 25^\circ\text{C}$, unless otherwise specified)

Symbol	Parameters	Test Conditions	Min	Typ	Max	Unit
IGBT						
$V_{GE(th)}$	Gate - Emitter Threshold Voltage	$V_{CE}=V_{GE}, I_C=2.0\text{mA}$	5.0	5.8	6.5	V
$V_{CE(sat)}$	Collector - Emitter	$I_C=50\text{A}, V_{GE}=15\text{V}, T_J=25^\circ\text{C}$		1.7		V
	Saturation Voltage	$I_C=50\text{A}, V_{GE}=15\text{V}, T_J=125^\circ\text{C}$		1.9		V
I_{ICES}	Collector Leakage Current	$V_{CE}=1200\text{V}, V_{GE}=0\text{V}, T_J=25^\circ\text{C}$			1	mA
		$V_{CE}=1200\text{V}, V_{GE}=0\text{V}, T_J=125^\circ\text{C}$			10	mA
I_{GES}	Gate Leakage Current	$V_{CE}=0\text{V}, V_{GE}=\pm 15\text{V}, T_J=125^\circ\text{C}$	-400		400	nA
R_{Gint}	Integrated Gate Resistor			4.0		Ω
Q_{ge}	Gate Charge	$V_{CE}=600\text{V}, I_C=50\text{A}, V_{GE}=\pm 15\text{V}$		0.47		μC
C_{ies}	Input Capacitance	$V_{CE}=25\text{V}, V_{GE}=0\text{V}, f=1\text{MHz}$		3.6		nF
C_{RES}	Reverse Transfer Capacitance			0.16		nF
$t_{d(on)}$	Turn - on Delay Time	$V_{CC}=600\text{V}$ $I_C=50\text{A}$ $R_G=18\Omega$ $V_{GE}=\pm 15\text{V}$ Inductive Load	$T_J=25^\circ\text{C}$	90		ns
			$T_J=125^\circ\text{C}$	90		ns
t_r	Rise Time		$T_J=25^\circ\text{C}$	30		ns
			$T_J=125^\circ\text{C}$	50		ns
$t_{d(off)}$	Turn - off Delay Time		$T_J=25^\circ\text{C}$	420		ns
			$T_J=125^\circ\text{C}$	520		ns
t_f	Fall Time		$T_J=25^\circ\text{C}$	70		ns
			$T_J=125^\circ\text{C}$	90		ns
E_{on}	Turn - on Energy		$T_J=25^\circ\text{C}$	4.9		mJ
			$T_J=125^\circ\text{C}$	6.6		mJ
E_{off}	Turn - off Energy		$T_J=25^\circ\text{C}$	4.0		mJ
			$T_J=125^\circ\text{C}$	4.9		mJ
I_{SC}	Short Circuit Current	$t_{psc} \leq 10\mu\text{S}, V_{GE}=15\text{V}, T_J=125^\circ\text{C}, V_{CC}=900\text{V}$		200		A
R_{thJC}	Junction-to-Case Thermal Resistance (Per IGBT)				0.48	K/W
Diode						
V_F	Forward Voltage	$I_F=50\text{A}, V_{GE}=0\text{V}, T_J=25^\circ\text{C}$		1.65		V
		$I_F=50\text{A}, V_{GE}=0\text{V}, T_J=125^\circ\text{C}$		1.65		V
t_{RR}	Reverse Recovery Time	$I_F=50\text{A}, V_R=600\text{V}$ $di_p/dt=1200\text{A}/\mu\text{s}$ $T_J=125^\circ\text{C}$		275		ns
I_{RRM}	Max. Reverse Recovery Current			50		A
E_{rec}	Reverse Recovery Energy			4.4		mJ
R_{thJD}	Junction-to-Case Thermal Resistance (Per Diode)				0.78	K/W

Diode-Rectifier Absolute Maximum Ratings ($T_J = 25^\circ\text{C}$, unless otherwise specified)

Symbol	Parameters	Test Conditions	Values	Unit
V_{RRM}	Repetitive Reverse Voltage	$T_J=25^\circ\text{C}$	1600	V
$I_{F(AV)}$	Average Forward Current	$T_C=80^\circ\text{C}$	50	A
I_{FRM}	Non-Repetitive Surge Forward Current	$T_J=45^\circ\text{C}$, $t=10\text{ms}$, 50Hz	350	A
		$T_J=45^\circ\text{C}$, $t=8.3\text{ms}$, 60Hz	385	
I^2t		$T_J=45^\circ\text{C}$, $t=10\text{ms}$, 50Hz	612	A ² s
		$T_J=45^\circ\text{C}$, $t=8.3\text{ms}$, 60Hz	741	

Diode-Rectifier Electrical and Thermal Specifications ($T_J = 25^\circ\text{C}$, unless otherwise specified)

Symbol	Parameters	Test Conditions	Min	Typ	Max	Unit
V_F	Forward Voltage	$I_F=50\text{A}$, $T_J=25^\circ\text{C}$		1.1		V
		$I_F=50\text{A}$, $T_J=125^\circ\text{C}$		1.05		V
I_R	Reverse Leakage Current	$V_R=1600\text{V}$, $T_J=25^\circ\text{C}$			50	μA
		$V_R=1600\text{V}$, $T_J=125^\circ\text{C}$			1	mA
R_{thJCD}	Junction-to-Case Thermal Resistance (Per Diode)				0.68	K/W

Brake-Chopper Absolute Maximum Ratings ($T_J = 25^\circ\text{C}$, unless otherwise specified)

Symbol	Parameters	Test Conditions	Values	Unit
IGBT				
V_{CES}	Collector - Emitter Voltage	$T_J=25^\circ\text{C}$	1200	V
V_{GES}	Gate - Emitter Voltage		± 20	V
I_C	DC Collector Current	$T_C=25^\circ\text{C}$	55	A
		$T_C=80^\circ\text{C}$	40	A
I_{CM}	Repetitive Peak Collector Current	$t_p=1\text{ms}$	80	A
P_{tot}	Power Dissipation Per IGBT		195	W
Diode				
V_{RRM}	Repetitive Reverse Voltage	$T_J=25^\circ\text{C}$	1200	V
$I_{F(AV)}$	Average Forward Current	$T_C=25^\circ\text{C}$	25	A
		$T_C=80^\circ\text{C}$	15	A
I_{FRM}	Repetitive Peak Forward Current	$t_p=1\text{ms}$	30	A
I^2t		$T_J=125^\circ\text{C}$, $t=10\text{ms}$, $V_R=0\text{V}$	60	A ² s

Brake-Chopper Electrical and Thermal Characteristics ($T_J = 25^\circ\text{C}$, unless otherwise specified)

Symbol	Parameters	Test Conditions	Min	Typ	Max	Unit
IGBT						
$V_{GE(th)}$	Gate - Emitter Threshold Voltage	$V_{CE}=V_{GE}, I_C=1.5\text{mA}$	5.0	5.8	6.5	V
$V_{CE(sat)}$	Collector - Emitter Saturation Voltage	$I_C=40\text{A}, V_{GE}=15\text{V}, T_J=25^\circ\text{C}$		1.8		V
		$I_C=40\text{A}, V_{GE}=15\text{V}, T_J=125^\circ\text{C}$		2.05		V
I_{ICES}	Collector Leakage Current	$V_{CE}=1200\text{V}, V_{GE}=0\text{V}, T_J=25^\circ\text{C}$			0.25	μA
		$V_{CE}=1200\text{V}, V_{GE}=0\text{V}, T_J=125^\circ\text{C}$			2	mA
I_{GES}	Gate Leakage Current	$V_{CE}=0\text{V}, V_{GE}=\pm 15\text{V}, T_J=125^\circ\text{C}$	-400		400	nA
R_{Gint}	Integrated Gate Resistor			6		Ω
Q_{ge}	Gate Charge	$V_{CE}=600\text{V}, I_C=40\text{A}, V_{GE}=\pm 15\text{V}$		0.33		μC
C_{ies}	Input Capacitance	$V_{CE}=25\text{V}, V_{GE}=0\text{V}, f=1\text{MHz}$		2.5		nF
C_{RES}	Reverse Transfer Capacitance			0.11		nF
$t_{d(on)}$	Turn - on Delay Time	$V_{CC}=600\text{V}$ $I_C=40\text{A}$ $R_G=27\Omega$ $V_{GE}=\pm 15\text{V}$ Inductive Load	$T_J=25^\circ\text{C}$	90		ns
			$T_J=125^\circ\text{C}$	90		ns
t_r	Rise Time		$T_J=25^\circ\text{C}$	30		ns
			$T_J=125^\circ\text{C}$	50		ns
$t_{d(off)}$	Turn - off Delay Time		$T_J=25^\circ\text{C}$	420		ns
			$T_J=125^\circ\text{C}$	520		ns
t_f	Fall Time		$T_J=25^\circ\text{C}$	70		ns
			$T_J=125^\circ\text{C}$	90		ns
E_{on}	Turn - on Energy		$T_J=25^\circ\text{C}$	4.1		mJ
			$T_J=125^\circ\text{C}$	6.0		mJ
E_{off}	Turn - off Energy	$T_J=25^\circ\text{C}$	3.1		mJ	
		$T_J=125^\circ\text{C}$	3.6		mJ	
I_{SC}	Short Circuit Current	$t_{psc}\leq 10\mu\text{s}, V_{GE}=15\text{V}, T_J=125^\circ\text{C}, V_{CC}=900\text{V}$		160		A
R_{thJC}	Junction-to-Case Thermal Resistance (Per IGBT)				0.62	K/W
Diode						
V_F	Forward Voltage	$I_F=15\text{A}, V_{GE}=0\text{V}, T_J=25^\circ\text{C}$		1.65		V
		$I_F=15\text{A}, V_{GE}=0\text{V}, T_J=125^\circ\text{C}$		1.75		V
t_{RR}	Reverse Recovery Time	$I_F=15\text{A}, V_R=600\text{V}$ $di_f/dt=-400\text{A}/\mu\text{s}$ $T_J=125^\circ\text{C}$		150		ns
I_{RRM}	Max. Reverse Recovery Current			15		A
E_{rec}	Reverse Recovery Energy			1.15		mJ
R_{thJCD}	Junction-to-Case Thermal Resistance (Per Diode)				1.55	K/W

NTC Characteristics ($T_J = 25^\circ\text{C}$, unless otherwise specified)

Symbol	Parameters	Test Conditions	Min	Typ	Max	Unit
R_{25}	Resistance	$T_c=25^\circ\text{C}$		5		K Ω
$B_{25/50}$				3375		K

Figure 1: Typical Output Characteristics for IGBT Inverter

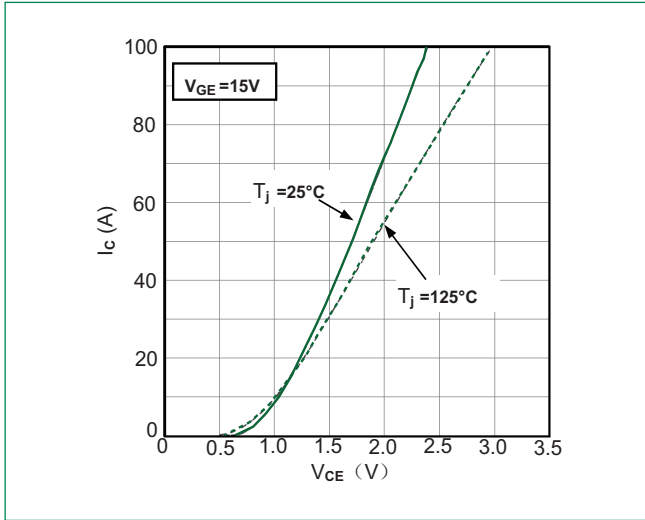

Figure 2: Typical Output Characteristics for IGBT Inverter

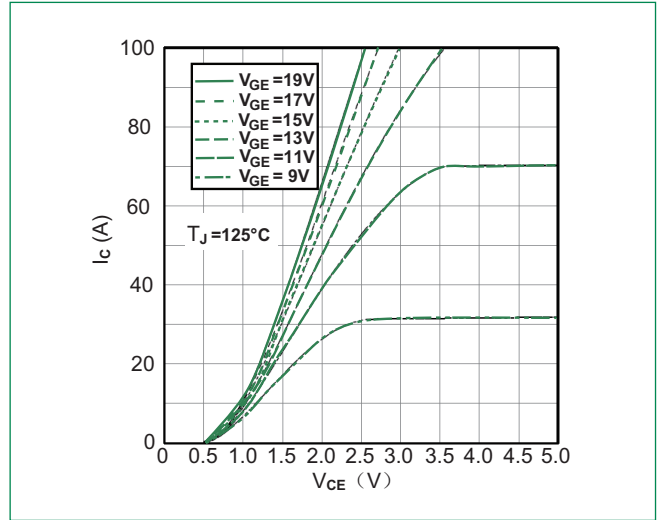

Figure 3: Typical Transfer Characteristics for IGBT Inverter

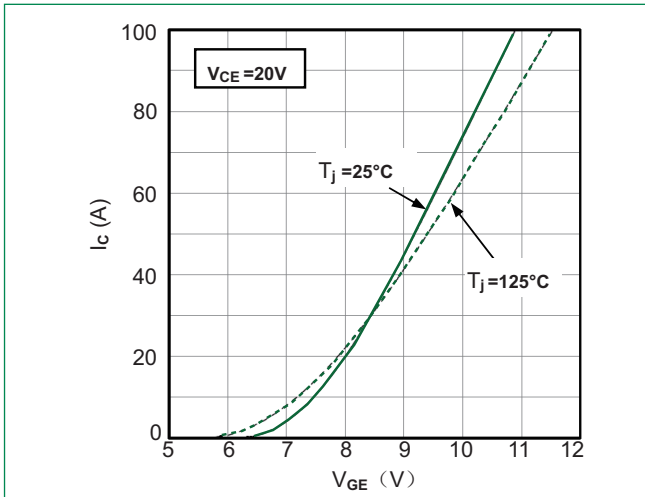

Figure 4: Switching Energy vs. Gate Resistor for IGBT Inverter

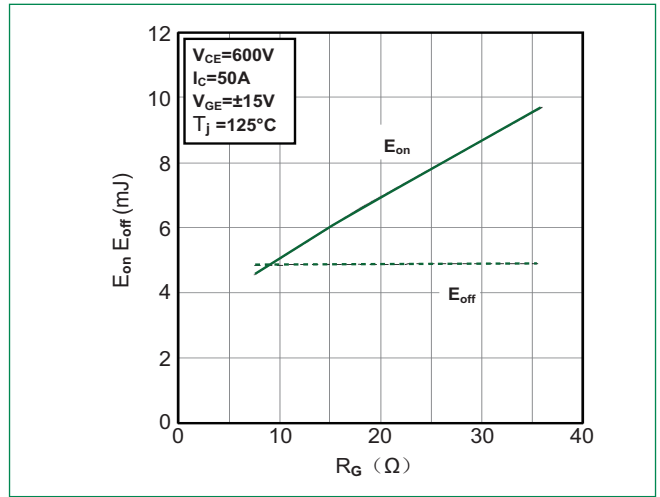

Figure 5: Switching Energy vs. Collector Current for IGBT Inverter

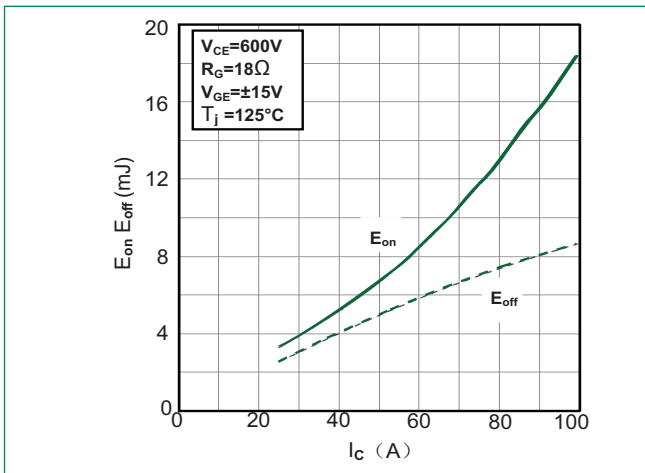

Figure 6: Reverse Biased Safe Operating Area for IGBT Inverter

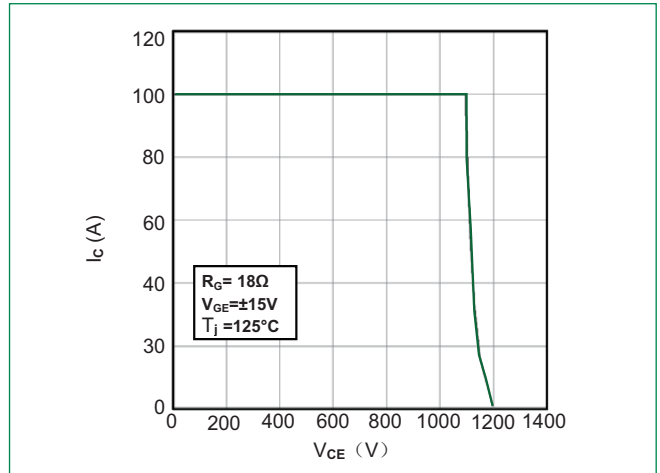

Figure 7: Diode Forward Characteristics for Diode Inverter

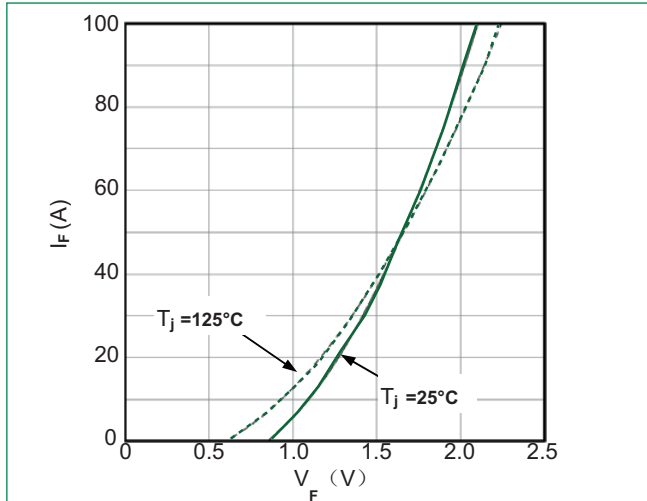

Figure 8: Switching Energy vs. Gate Resistort for Diode Inverter

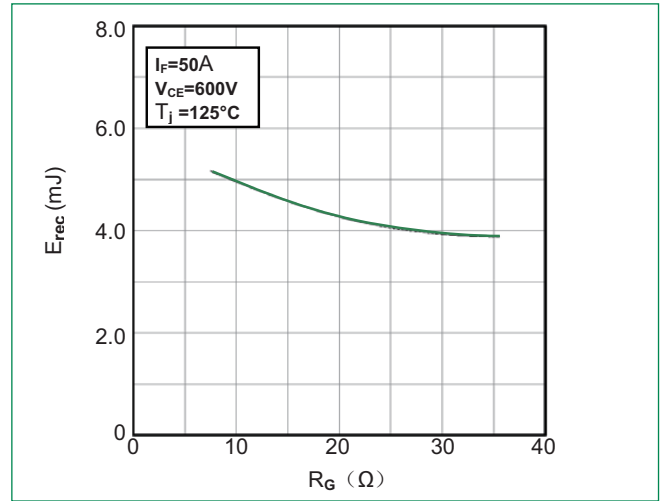

Figure 9: Switching Energy vs. Forward Current for Diode Inverter

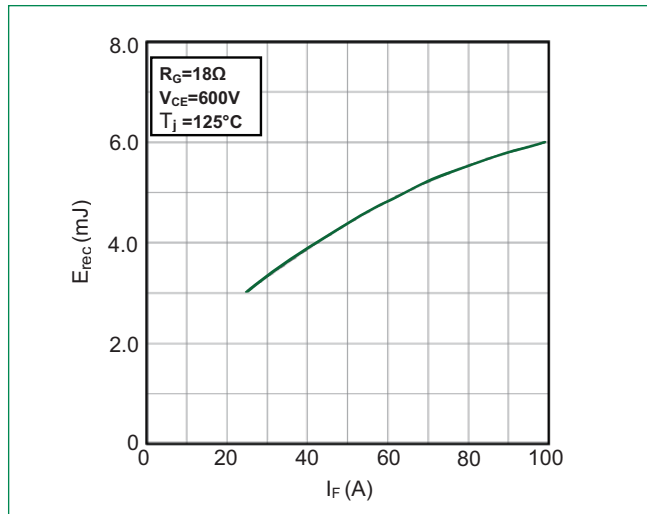

Figure 10: Transient Thermal Impedance of Diode and IGBT Inverter

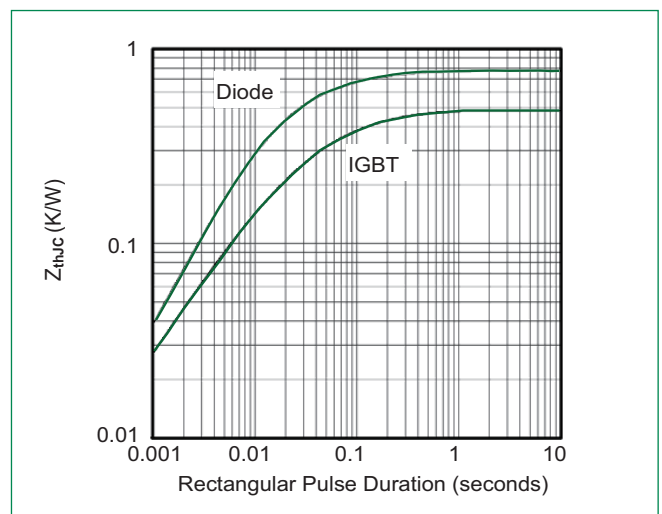

Figure 11: Diode Forward Characteristics for IGBT Inverter

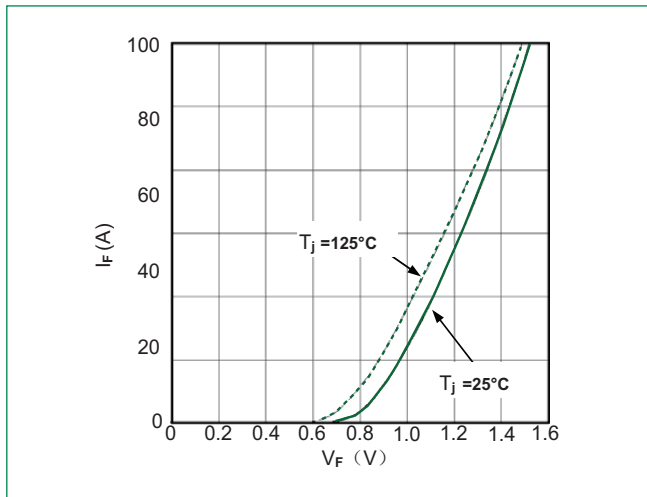

Figure 12: Typical Output Characteristics for IGBT Brake Chopper

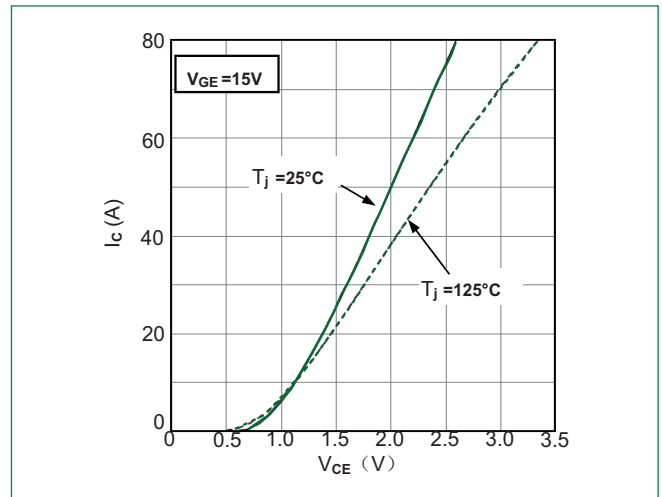

Figure 13: Diode Forward Characteristics for Diode Brake Chopper

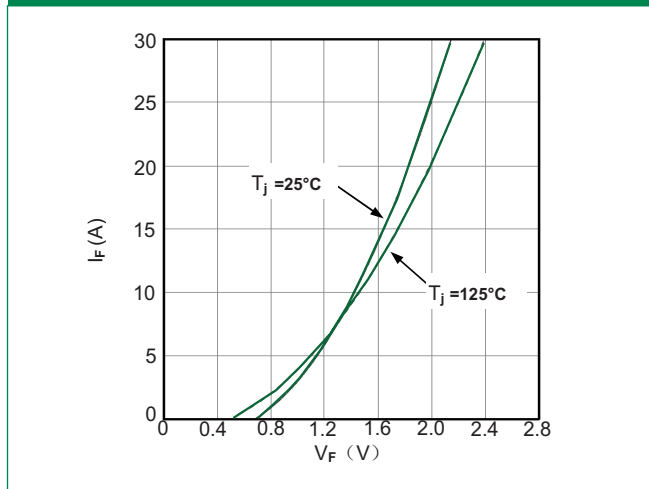
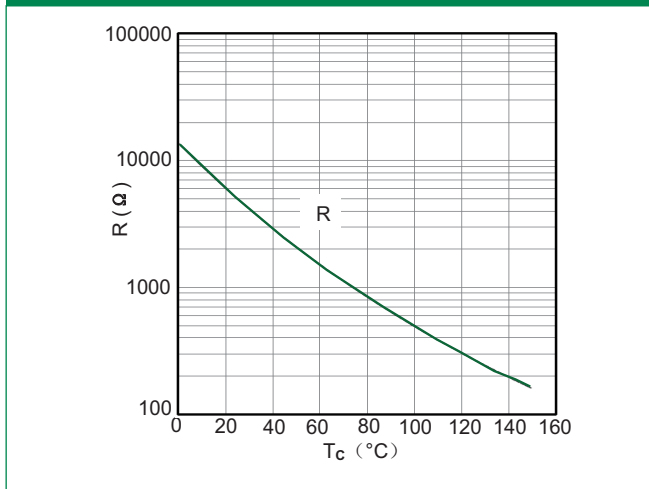
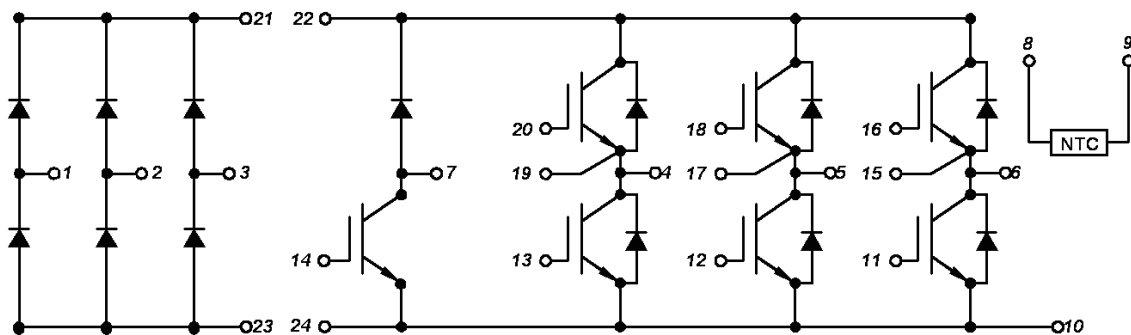

Figure 14: NTC Characteristics



Circuit Diagram



Part Numbering System

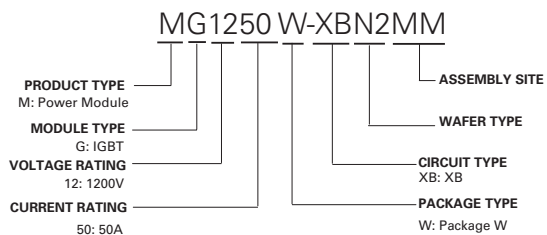

Part Marking System

