

### 473 Series, PICO® II Slo-Blo® Fuse



#### Description

The PICO® II Slo-Blo® Fuse combines time-delay performance characteristics with the proven reliability of a PICO® Fuse.

#### Features

- Enhanced inrush withstand
- Small size
- Wide range of current ratings (0.375A - 7A)
- Halogen free and RoHS compliant
- Wide operating temperature range
- Low temperature derating



#### Applications

- Flat-panel Display TV
- LCD monitor
- Lighting system
- Medical equipment
- Industrial equipment

#### Electrical Characteristics

% of Ampere Rating	Opening Time
100%	4 Hours, <b>Min.</b>
200%	1 Sec., <b>Min.</b> ; 60 Sec., <b>Max.</b>
300%	0.2 Sec., <b>Min.</b> ; 3 Sec., <b>Max.</b>
800%	0.002 Sec., <b>Min.</b> ; 0.1 Sec., <b>Max.</b>

#### Agency Approvals

Agency	Agency File Number	Ampere Range
	E10480	0.375A - 7A
	29862	0.375A - 7A
	NBK200416-JP1021	1A - 5A

#### Additional Information



Datashheet





Resources



Samples

#### Electrical Characteristics

Ampere Rating (A)	Amp Code	Max Voltage Rating (V)	Interrupting Rating	Nominal Cold Resistance (Ohms)	Nominal Melting I <sup>2</sup> t (A <sup>2</sup> sec)	Nom Voltage Drop (mV)	Agency Approvals		
									
0.375	.375	125	50A@125VAC/DC	1.7550	0.085	0.840	X	X	
0.500	.500	125		1.1370	0.210	0.775	X	X	
0.750	.750	125		0.4900	0.760	0.429	X	X	
1.00	.001.	125		0.3000	2.010	0.353	X	X	X
1.50	01.5	125		0.1170	3.940	0.208	X	X	X
2.00	002.	125		0.0720	7.600	0.180	X	X	X
2.25	2.25	125		0.0640	9.280	0.164	X	X	X
2.50	02.5	125		0.0520	13.00	0.153	X	X	X
3.00	003.	125		0.0380	21.00	0.140	X	X	X
3.50	03.5	125		0.0240	26.80	0.094	X	X	X
4.00	004.	125		0.0200	35.00	0.086	X	X	X
5.00	005.	125		0.0133	54.80	0.074	X	X	X
7.00	007.	125		0.0092	105.00	0.070	X	X	

### Temperature Re-rating Curve

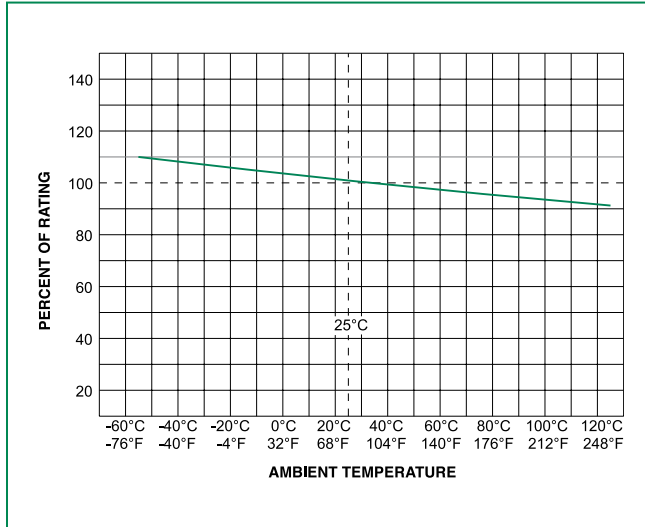

Note:  
 Rerating depicted in this curve is in addition to the standard derating of 25% for continuous operation.

### Average Time Current Curves

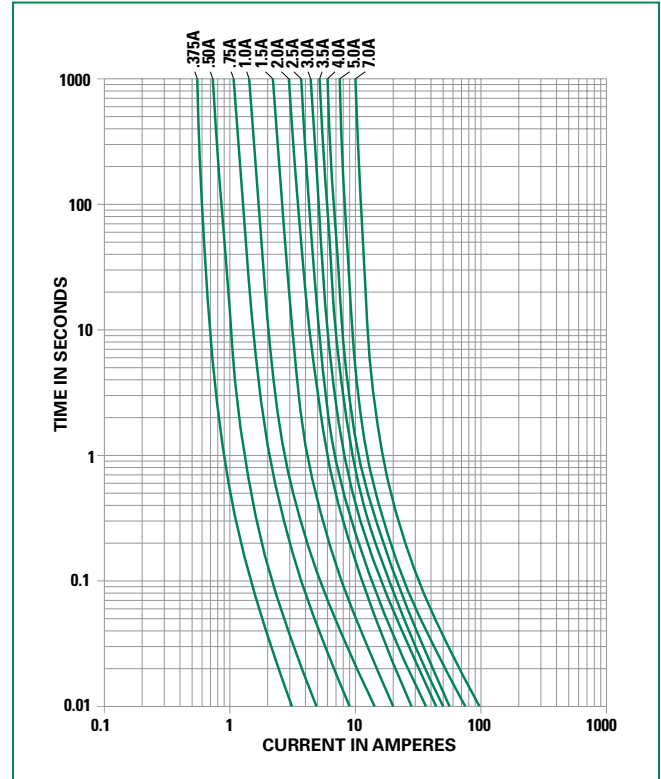

### Soldering Parameters

#### Recommended Process Parameters:

Wave Parameter	Lead-Free Recommendation
<b>Preheat:</b> (Depends on Flux Activation Temperature)	(Typical Industry Recommendation)
Temperature Minimum:	100°C
Temperature Maximum:	150°C
Preheat Time:	60-180 seconds
<b>Solder Pot Temperature:</b>	260°C Maximum
<b>Solder Dwell Time:</b>	2-5 seconds

#### Recommended Hand-Solder Parameters:

Solder Iron Temperature: 350°C +/- 5°C  
 Heating Time: 5 seconds max.

**Note: These devices are not recommended for IR or Convection Reflow process.**

### Product Characteristics

<b>Materials</b>	Encapsulated, Epoxy-Coated Body; Solder Coated Copper wire leads; RoHS compliant Product: Pure Tin-coated Copper wire leads
<b>Solderability</b>	MIL-STD-202, Method 208
<b>Lead Pull Force</b>	MIL-STD-202, Method 211, Test Condition A (will withstand 7 lbs. axial pull test)
<b>Operating Temperature</b>	-60°C to +125°C (Consider re-rating)
<b>Shock</b>	MIL-STD-202, Method 213, Test Condition I (100 G's peak for 6 milliseconds)

<b>Vibration</b>	MIL-STD-202, Method 201 (10–55 Hz); MIL-STD-202, Method 204, Test Condition C (55–2000 Hz at 10 G's Peak)
<b>Salt Spray</b>	MIL-STD-202, Method 101, Test Condition B
<b>Insulation Resistance (After Opening):</b>	MIL-STD-202, Method 302, (10,000 ohms minimum at 100 volts)
<b>Resistance to Soldering Heat</b>	MIL-STD-202, Method 210, Test Condition C (20 sec at 260°C)
<b>Thermal Shock</b>	MIL-STD-202, Method 107, Test Condition B (-65°C to 125°C)
<b>Moisture Resistance</b>	MIL-STD-202, Method 106 (90–98% RH), Heat (65°C)

### Dimensions

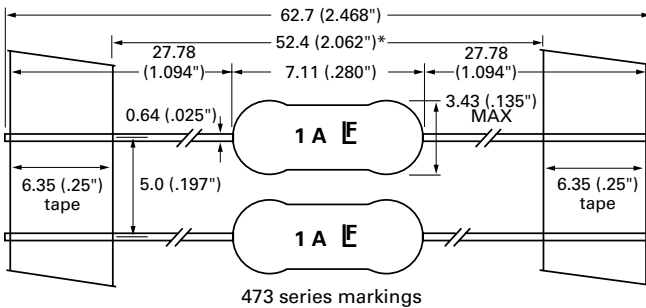

### Part Numbering System

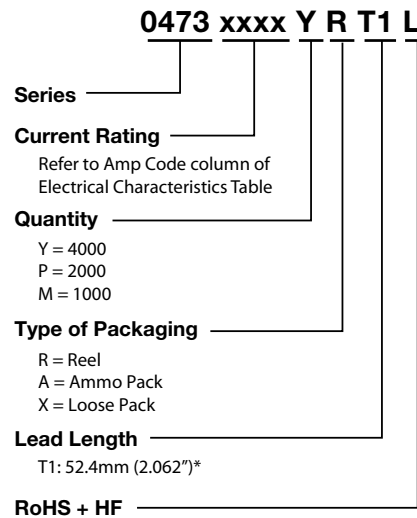

### Packaging

Packaging Option	Packaging Specification	Quantity & Packaging Code
*T1: 52.4mm (2.062") Tape and Reel	EIA 296	Please refer to available quantities above in "Part Numbering System"

Notes: \* T1 dimension is defined as the length of the component between the two tapes. The full component length is 62.7mm (2.468").

**Disclaimer Notice** - Littelfuse products are not designed for, and shall not be used for, any purpose (including, without limitation, automotive, military, aerospace, medical, life-saving, life-sustaining or nuclear facility applications, devices intended for surgical implant into the body, or any other application in which the failure or lack of desired operation of the product may result in personal injury, death, or property damage) other than those expressly set forth in applicable Littelfuse product documentation. Warranties granted by Littelfuse shall be deemed void for products used for any purpose not expressly set forth in applicable Littelfuse documentation. Littelfuse shall not be liable for any claims or damages arising out of products used in applications not expressly intended by Littelfuse as set forth in applicable Littelfuse documentation. The sale and use of Littelfuse products is subject to Littelfuse Terms and Conditions of Sale, unless otherwise agreed by Littelfuse. Information furnished is believed to be accurate and reliable. However, users should independently evaluate the suitability of and test each product selected for their own applications. Littelfuse products are not designed for, and may not be used in, all applications. Read complete Disclaimer Notice at [www.littelfuse.com/disclaimer-electronics](http://www.littelfuse.com/disclaimer-electronics).