

SMTOAK2 Series

Surface Mount – SMTO-263-2 kA



Web Resources



Download ECAD models, order samples, and find technical resources at www.littelfuse.com

Agency Approvals

Agency	Agency file number
	E230531

Maximum Ratings and Thermal Characteristics

($T_A=25\text{ }^\circ\text{C}$ unless otherwise noted)

Parameter	Symbol	Value	Unit
Current Rating ¹	I_{PP}	2	kA
Steady State Power Dissipation on Infinite Heat Sink at $T_A=75\text{ }^\circ\text{C}$	P_D	15	W
Operating Junction and Storage Temperature Range	T_J, T_{STG}	-55 to 150	$^\circ\text{C}$
Typical Thermal Resistance Junction to case	$R_{\theta JC}$	1.8	$^\circ\text{C/W}$

Note:

1. Rated I_{PP} measured with 8/20 μs pulse.

Functional Diagram



Bi-directional

Description

The SMTOAK2 TVS Diode Series is housed in a modified SMTO-263 package, achieving a compact mechanical design and compatible with automated PCB assembly. The SMTOAK2 series is designed to protect sensitive electronics against surge events and inductive load switching voltage transient events. The SMTOAK2 series offers superior clamping characteristics over standard S.A.D. technologies by virtue of the Littelfuse Foldbak™ technology, which provides a clamping voltage lower than the avalanche voltage (but above the rated working voltage).

Features & Benefits

- SMTO-263 package, footprint compatible with industry popular DO-218AB package
- $V_{BR} @ T_J = V_{BR} @ 25\text{ }^\circ\text{C} \times (1 + \alpha T (T_J - 25))$ (α : Temperature Coefficient, typical value is 0.1%)
- Glass passivated chip junction in modified TO-263 package
- Whisker test is conducted based on JEDEC JESD201A per its table 4a and 4c pass class 1/1A/2
- Foldbak™ technology for superior clamping factor
- IEC 61000-4-2 ESD 30 kV(Air), 30 kV (Contact)
- Fast response time: typically less than 1.0 ps from 0 Volts to $V_{BR\text{ min}}$
- Excellent clamping capability
- Low dynamic resistance
- UL recognized compound meeting flammability rating V-0
- Ideal for automated PCB assembly process, reducing manufacturing costs and improving soldering quality, as compared to axial leaded packages
- Matte tin lead-free plated
- Halogen free and RoHS compliant
- Pb-free E3 means 2nd level interconnect is Pb-free and the terminal finish material is tin (Sn) (IPC/JEDEC J-STD-609A.01)
- Recognized to UL 497B as an Isolated Loop Circuit Protector

Applications

Designed to protect sensitive electronics from:

- Over voltage surge transients
- Inductive load switching voltage transients
- PoE ports
- Small cell
- Remote Radio Units (RRUs) and Baseband Units (BBUs)
- High power DC bus in harsh environments

SMTOAK2 Series

Surface Mount – SMT0-263-2 kA

Electrical Characteristics ($T_A=25\text{ }^\circ\text{C}$ unless otherwise noted)

Part Number	Part Marking	Stand off Voltage V_{SO}	Breakdown Voltage V_{BR} (Volts) @ I_T		Test Current I_T	Maximum Peak Pulse Current I_{PP} (10/350 μs)	Maximum Clamping Voltage V_C @ I_{PP} (8/20 μs)	Maximum Peak Pulse Current I_{PP} (8/20 μs)	Maximum Reverse Leakage I_R @ V_R	Maximum Temperature coefficient of V_{BR}
			(V)	Min						
SMTOAK2-070C	SM2K70C	70	78.20	86.02	5	250	130	2000	2	0.074
SMTOAK2-066C	SM2K66C	66	73.73	81.10	5	200	108	2000	2	0.072
SMTOAK2-070C	SM2K70C	70	78.20	86.02	5	250	113	2000	2	0.074
SMTOAK2-076C	SM2K76C	76	84.91	93.39	5	360	120	2000	2	0.077

I-V Curve Characteristics

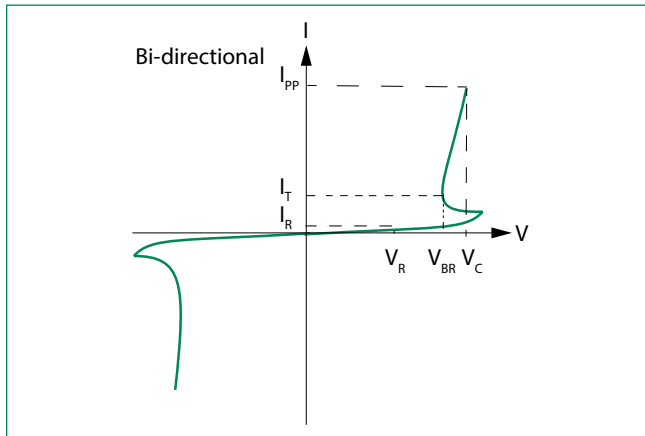

V_{SO} Stand-off Voltage – Maximum voltage that can be applied to the TVS without operation

V_{BR} Breakdown Voltage – Maximum voltage that flows through the TVS at a specified test current (I_T)

V_C Clamping Voltage – Peak voltage measured across the TVS at a specified I_{PPM} (peak impulse current)

I_R Reverse Leakage Current – Current measured at V_R

SMT0AK2 Series

Surface Mount – SMT0-263-2 kA

Ratings and Characteristic Curves ($T_A=25\text{ }^\circ\text{C}$ unless otherwise noted)

Figure 1:
Peak Pulse Power Rating Curve

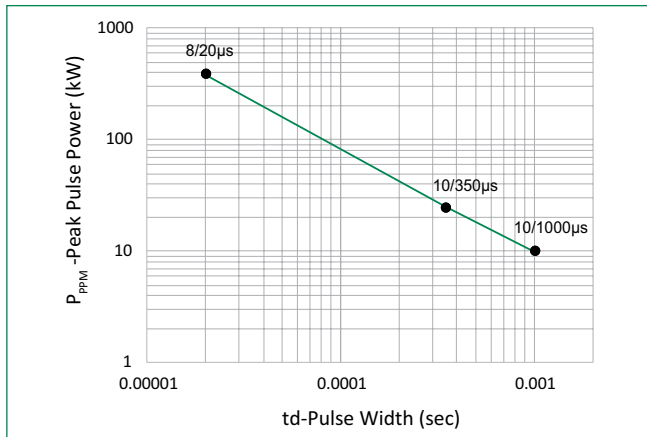

Figure 2:
Peak Pulse Power Derating Curve

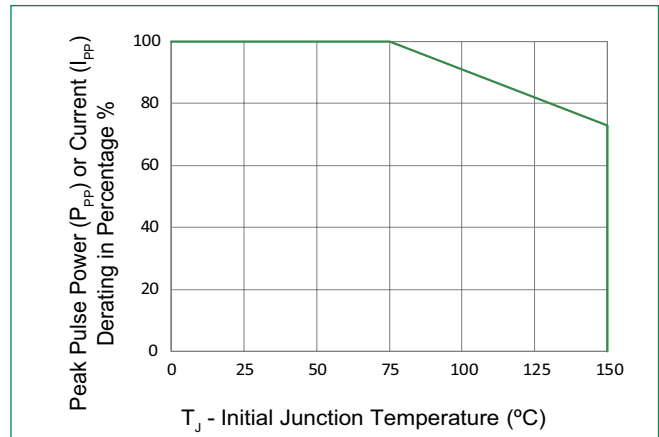
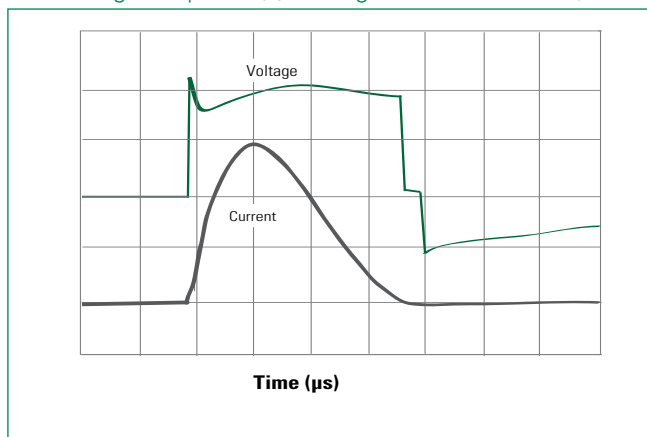

Figure 3:
Surge Response (8/20 Surge current waveform)



Note: The power dissipation causes a change in avalanche voltage during the surge and the avalanche voltage eventually returns to the original value when the transient has passed.

SMT0AK2 Series

Surface Mount – SMT0-263-2 kA

Soldering Parameters

Reflow Condition		Pb – Free assembly
Pre Heat	- Temperature Min ($T_{s(min)}$)	150 °C
	- Temperature Max ($T_{s(max)}$)	200 °C
	- Time (min to max) (t_s)	60 – 120 secs
Average ramp up rate (Liquidus Temp (T_L) to peak)		5 °C/second max
$T_{s(max)}$ to T_A - Ramp-up Rate		5 °C/second max
Reflow	- Temperature (T_L) (Liquidus)	217 °C
	- Time (min to max) (T_s)	60 – 150 seconds
Peak Temperature (T_p)		245 ^{+0/-5} °C
Time within 5 °C of actual peak Temperature (t_p)		30 seconds
Ramp-down Rate		5 °C/second max
Time 25 °C to peak Temperature (T_p)		8 minutes Max.
Do not exceed		245 °C

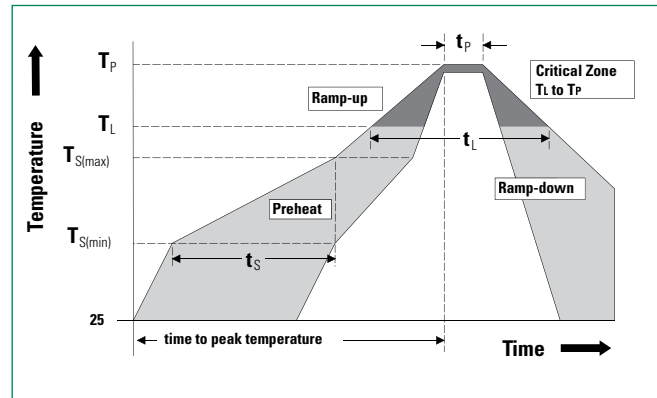

Physical Specifications

Weight	0.065 ounce, 1.85 grams
Case	JEDEC DO214AB. Molded component over glass passivated junction
Terminal	Matte Tin-plated leads, solderable per JESD22-B102

Environmental Specifications

High Temp Voltage Blocking (HTRB)	100% DC reverse voltage rated 150°C, 1008 hrs. JEDEC, JESD22-A-108
Biased Temp & Humidity (H3TRB)	1008 hours at $T_A = 85^\circ\text{C}/85\% \text{RH}$ with part reverse biased at 80% of rated breakdown voltage. JEDEC, JESD22-A-101
Unbiased Highly Accelerated Stress Test (UAHST)	96 hours at $T_A = 130^\circ\text{C}/85\% \text{RH}$. JEDEC, JESD22-A-118
Temp Cycle (TC)	-55°C to +150°C, 15 min. dwell, 1000 cycles. JEDEC, JESD22-A104
Resistance to soldering heat (RSH)	+260°C, 30 secs. JEDEC JESD22-A111
Moisture Sensitivity Level (MSL)	85%RH, +85°C, 168 hrs., 3 reflow cycles (+260°C Peak). JEDEC-J-STD-020, Level 1

Dimensions

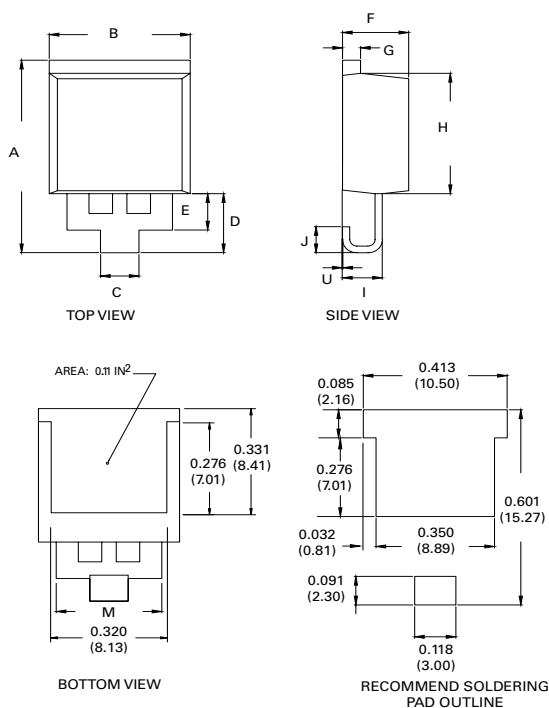

Dimensions	Inches		Millimeters	
	Min	Max	Min	Max
A	0.568	0.600	14.44	15.24
B	0.380	0.420	9.65	10.67
C	0.098	0.114	2.50	2.90
D	0.169	0.189	4.30	4.80
E	0.102	0.118	2.60	3.00
F	0.178	0.188	4.52	4.78
G	0.045	0.060	1.14	1.52
H	0.360	0.370	9.14	9.40
I	0.106	0.122	2.69	3.09
J	0.069	0.089	1.75	2.25
M	0.284	0.300	7.22	7.62
U	0	0.010	0	0.25

SMT0AK2 Series

Surface Mount – SMT0-263-2 kA

Part Numbering System

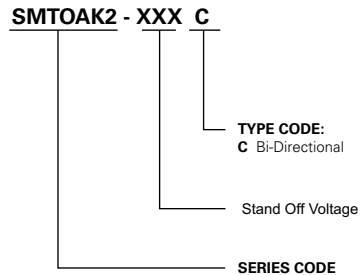

Part Marking System

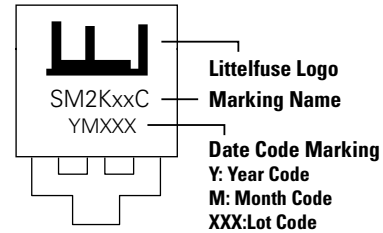

Packing Option

Part Number	Component Package	Quantity	Packaging Option	Packaging Specification
SMTAK2-XXX-C	SMT0-263	500	Tape & Reel - 24mm tape/13" reel	EIA STD RS-481

SMT0-263 Embossed Carrier Reel Pack (RP) Specifications

Meets all EIA-481-2 Standards

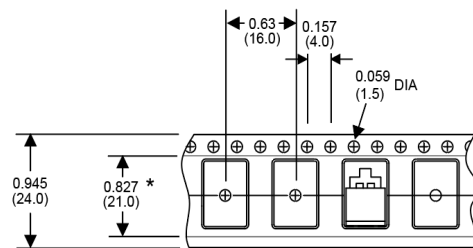

* Cover tape

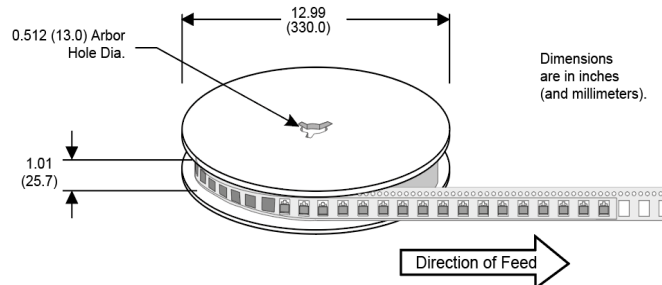

Disclaimer Notice - Information furnished is believed to be accurate and reliable. However, users should independently evaluate the suitability of and test each product selected for their own applications. Littelfuse products are not designed for, and may not be used in, all applications. Read complete Disclaimer Notice at <http://www.littelfuse.com/disclaimer-electronics>.