

SP1001 Series

8pF 15kV Unidirectional TVS Array

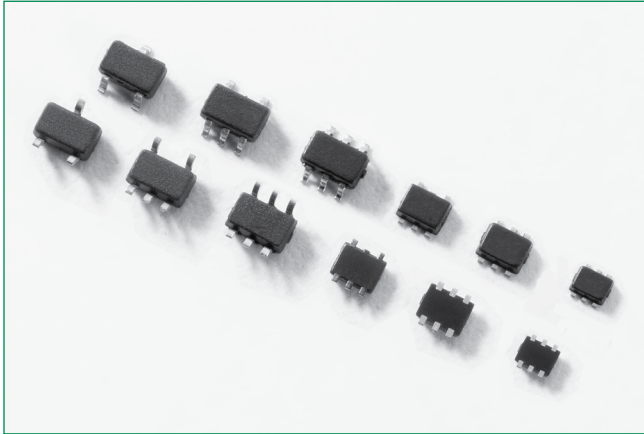

Web Resources



Download ECAD models, order samples, and find technical resources at www.littelfuse.com

Description

Avalanche breakdown diodes fabricated in a proprietary silicon avalanche technology protect each I/O pin to provide a high level of protection for electronic equipment that may experience destructive electrostatic discharges (ESD). These robust diodes can safely absorb repetitive ESD strikes above the maximum level specified in IEC 61000-4-2 international standard (Level 4, $\pm 8\text{kV}$ contact discharge) without performance degradation. Their very low loading capacitance also makes them ideal for protecting high-speed signal pins.

Features & Benefits

- Low capacitance of 8pF (TYP) per I/O
- ESD protection of $\pm 15\text{kV}$ contact discharge, $\pm 30\text{kV}$ air discharge, (Level 4, IEC 61000-4-2)
- EFT protection, IEC 61000-4-4, 40A (5/50ns)
- Low leakage current of $0.5\mu\text{A}$ (MAX) at 5V
- Small package saves board space
- Lightning Protection, IEC 61000-4-5, 2A (8/20 μs)
- AEC-Q101 Qualified

Applications

- Computer Peripherals
- Mobile Phones
- Digital Cameras
- Desktops/Notebooks
- LCD/PDPTVs
- Set Top Boxes
- DVD Players
- MP3/PMP

Pinout

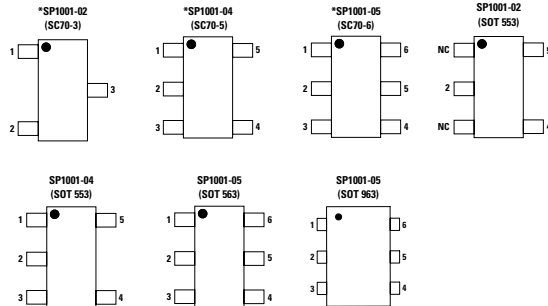

Note: * AEC-Q101 Qualified

Functional Block Diagram

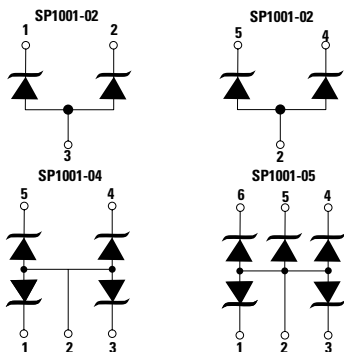

Application Example

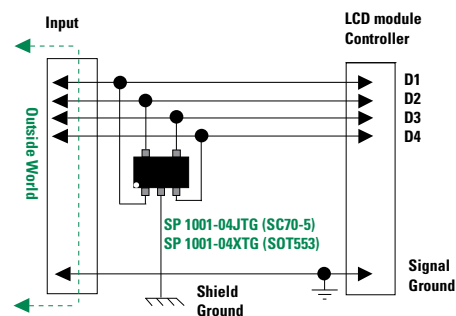

Life Support Note:

Not Intended for Use in Life Support or Life Saving Applications

The products shown herein are not designed for use in life sustaining or life saving applications unless otherwise expressly indicated.

SP1001 Series

8pF 15kV Unidirectional TVS Array

Absolute Maximum Ratings

Symbol	Parameter	Value	Units
I_{PP}	Peak Current ($t_p=8/20\mu s$)	2	A
T_{OP}	Operating Temperature	-40 to 125	°C
T_{STOR}	Storage Temperature	-505 to 150	°C

Caution: Stresses above those listed in "Absolute Maximum Ratings" may cause permanent damage to the component. This is a stress only rating and operation of the component at these or any other conditions above those indicated in the operational sections of this specification is not implied.

Thermal Information

Parameter	Rating	Units
Storage Temperature Range	-55 to 150	°C
Maximum Junction Temperature	150	°C
Maximum Lead Temperature (Soldering 20-40s)	260	°C
Thermal resistance junction to ambient	124.21	°C/W
Thermal resistance junction to case	190.54	°C/W
Power dissipation	1	W

Electrical Characteristics ($T_{OP} = 25^\circ C$)

Parameter	Symbol	Test Conditions	Min	Typ	Max	Units
Forward Voltage Drop	V_F	$I_F=10mA$	0.7	0.9	1.2	V
Reverse Voltage Drop	V_R	$I_R=1mA$	7.0	7.8	8.5	V
Reverse Standoff Voltage	V_{RWM}	$I_R \leq 1\mu A$	-	-	5.5	V
Reverse Leakage Current	I_{LEAK}	$V_R=5V$	-	-	0.1	μA
Clamp Voltage ¹	V_C	$I_{PP}=1A, t_p=8/20\mu s, Fwd$	-	8.0	11.0	V
		$I_{PP}=2A, t_p=8/20\mu s, Fwd$	-	9.7	13.0	V
Dynamic Resistance	R_{DYN}	$(V_{C2} - V_{C1}) / (I_{PP2} - I_{PP1})$	-	1.7	-	Ω
ESD Withstand Voltage ^{1,2}	V_{ESD}	IEC 61000-4-2 (Contact)	± 15	-	-	kV
		IEC 61000-4-2 (Air)	± 30	-	-	kV
Diode Capacitance ¹	C_D	Reverse Bias=0V	-	12	-	pF
		Reverse Bias=2.5V	-	8	-	pF
		Reverse Bias=5V	-	7	-	pF

Notes:

¹ Parameter is guaranteed by component characterization

² A minimum of 1,000 ESD pulses are applied at 1s intervals between the anode and common cathode of each diode

Capacitance vs. Reverse Bias

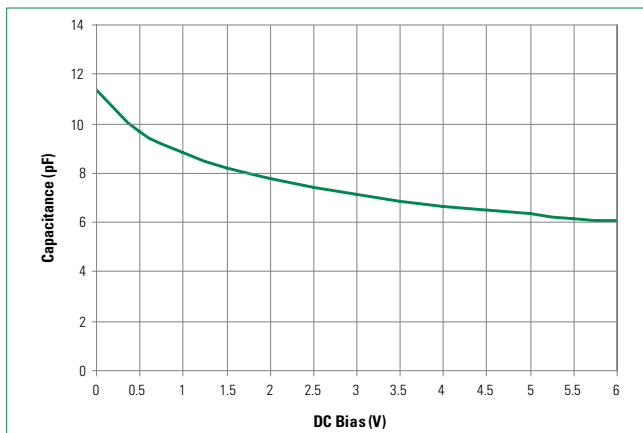

Design Consideration

Because of the fast rise-time of the ESD transient, placement of ESD components is a key design consideration. To achieve optimal ESD suppression, the components should be placed on the circuit board as close to the source of the ESD transient as possible. Install the ESD suppressors directly behind the connector so that they are the first board-level circuit component encountered by the ESD transient. They are connected from signal/data line to ground.

SP1001 Series

8pF 15kV Unidirectional TVS Array

Soldering Parameters

Reflow Condition		Pb – Free assembly
Pre Heat	- Temperature Min ($T_{s(min)}$)	150°C
	- Temperature Max ($T_{s(max)}$)	200°C
	- Time (min to max) (t_s)	60 – 180 secs
Average ramp up rate (Liquidus) Temp (T_L) to peak		3°C/second max
$T_{s(max)}$ to T_L - Ramp-up Rate		3°C/second max
Reflow	- Temperature (T_L) (Liquidus)	217°C
	- Temperature (t_L)	60 – 150 seconds
Peak Temperature (T_p)		260 ^{+0/-5} °C
Time within 5°C of actual peak Temperature (t_p)		20 – 40 seconds
Ramp-down Rate		6°C/second max
Time 25°C to peak Temperature (T_p)		8 minutes max.
Do not exceed		260°C

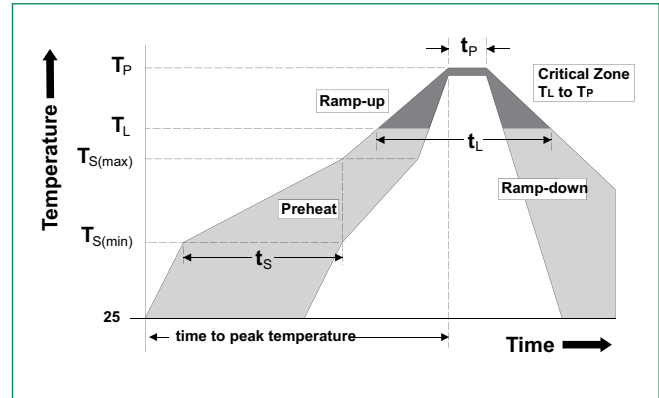

Part Numbering System

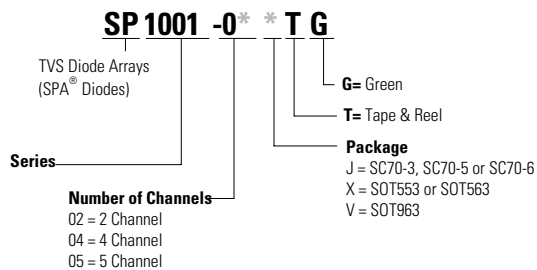

Product Characteristics

Lead Plating	Matte Tin (SC70-x) Pre-Plated Frame (SOT5x3, SOT963)
Lead Material	Copper Alloy
Lead Coplanarity	0.004 inches(0.102mm)
Substrate material	Silicon
Body Material	Molded Compound
Flammability	UL Recognized compound meeting flammability rating V-0

Notes :

- All dimensions are in millimeters
- Dimensions include solder plating.
- Dimensions are exclusive of mold flash & metal burr.

Part Marking System

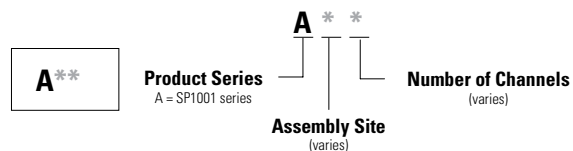

Ordering Information

Part Number	Package	Marking	Min. Order Qty.
SP1001-02JTG	SC70-3	A*2	3000
SP1001-02XTG	SOT553	A*2	3000
SP1001-04JTG	SC70-5	A*4	3000
SP1001-04XTG	SOT553	A*4	3000
SP1001-05JTG	SC70-6	A*5	3000
SP1001-05VTG	SOT963	A5	8000
SP1001-05XTG	SOT563	A*5	3000

SP1001 Series

8pF 15kV Unidirectional TVS Array

Package Dimensions — SC70

SC70-3

Solder Pad Layout

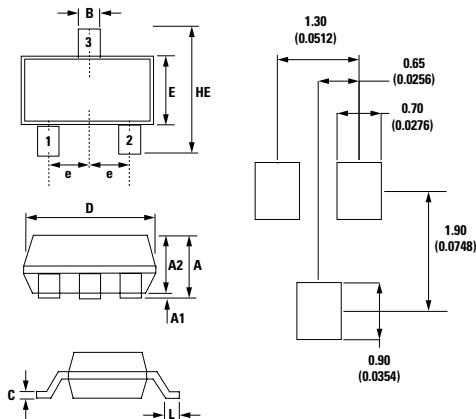

Package	SC70-3			
Pins	3			
JEDEC	MO-203			
	Millimeters		Inches	
	Min	Max	Min	Max
A	0.80	1.10	0.031	0.043
A1	0.00	0.10	0.000	0.004
A2	0.70	1.00	0.028	0.039
B	0.15	0.40	0.006	0.016
c	0.08	0.25	0.003	0.010
D	1.85	2.25	0.073	0.089
E	1.15	1.35	0.045	0.053
e	0.66 BSC		0.026 BSC	
HE	2.00	2.45	0.079	0.096
L	0.26	0.46	0.010	0.018

SC70-5

Solder Pad Layout

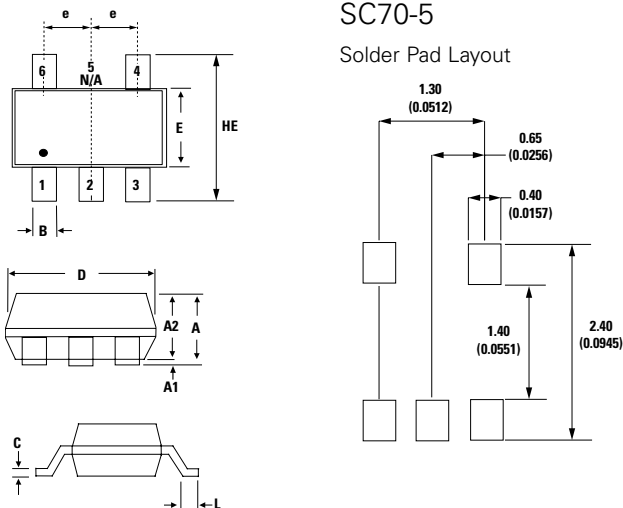

Package	SC70-5			
Pins	5			
JEDEC	MO-203			
	Millimeters		Inches	
	Min	Max	Min	Max
A	0.80	1.10	0.031	0.043
A1	0.00	0.10	0.000	0.004
A2	0.70	1.00	0.028	0.039
B	0.15	0.30	0.006	0.012
c	0.08	0.25	0.003	0.010
D	1.85	2.25	0.073	0.089
E	1.15	1.35	0.045	0.053
e	0.65 BSC		0.026 BSC	
HE	2.00	2.40	0.079	0.094
L	0.26	0.46	0.010	0.018

SC70-6

Solder Pad Layout

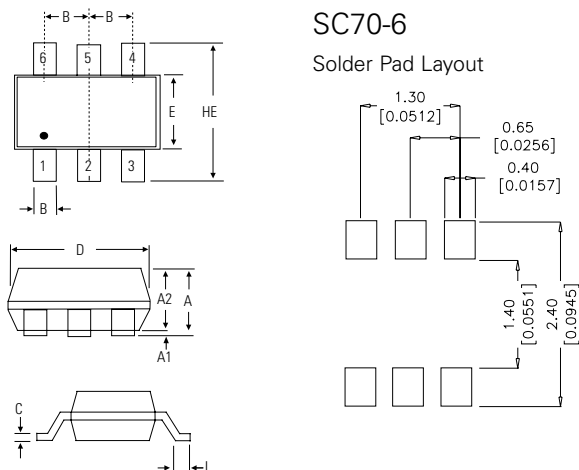

Package	SC70-6			
Pins	6			
JEDEC	MO-203			
	Millimeters		Inches	
	Min	Max	Min	Max
A	0.80	1.10	0.031	0.043
A1	0.00	0.10	0.000	0.004
A2	0.70	1.00	0.028	0.039
B	0.15	0.30	0.006	0.012
c	0.08	0.25	0.003	0.010
D	1.85	2.25	0.073	0.089
E	1.15	1.35	0.045	0.053
e	0.65 BSC		0.026 BSC	
HE	2.00	2.40	0.079	0.094
L	0.26	0.46	0.010	0.018

SP1001 Series

8pF 15kV Unidirectional TVS Array

Package Dimensions – SOT553 and SOT563

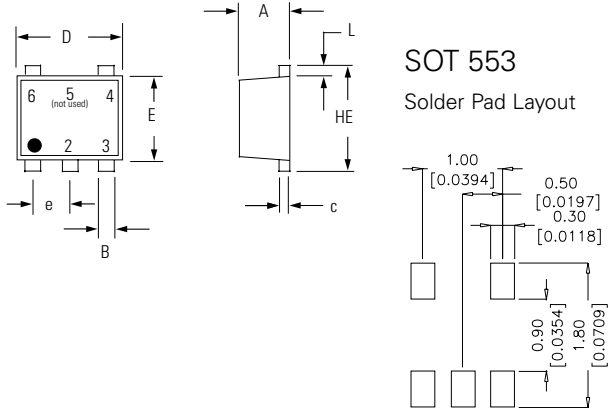

Package	SOT 553			
Pins	5			
	Millimeters		Inches	
	Min	Max	Min	Max
A	0.50	0.60	0.020	0.024
B	0.17	0.27	0.007	0.011
c	0.08	0.18	0.003	0.007
D	1.50	1.70	0.059	0.067
E	1.10	1.30	0.043	0.051
e	0.50 BSC		0.020 BSC	
L	0.10	0.30	0.004	0.012
HE	1.50	1.70	0.059	0.067

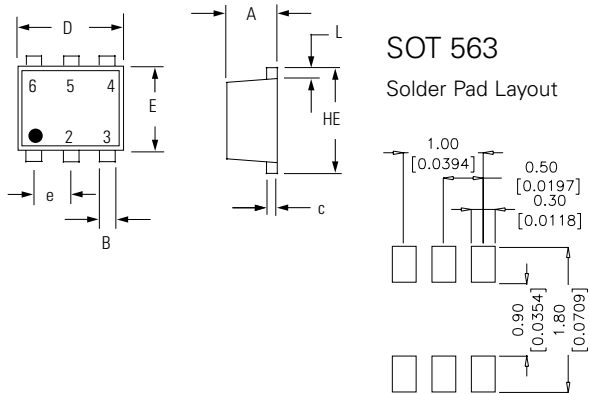

Package	SOT 563			
Pins	6			
	Millimeters		Inches	
	Min	Max	Min	Max
A	0.50	0.60	0.020	0.024
B	0.17	0.27	0.007	0.011
c	0.08	0.18	0.003	0.007
D	1.50	1.70	0.059	0.067
E	1.10	1.30	0.043	0.051
e	0.50 BSC		0.020 BSC	
L	0.10	0.30	0.004	0.012
HE	1.50	1.70	0.059	0.067

Package Dimensions – SOT963

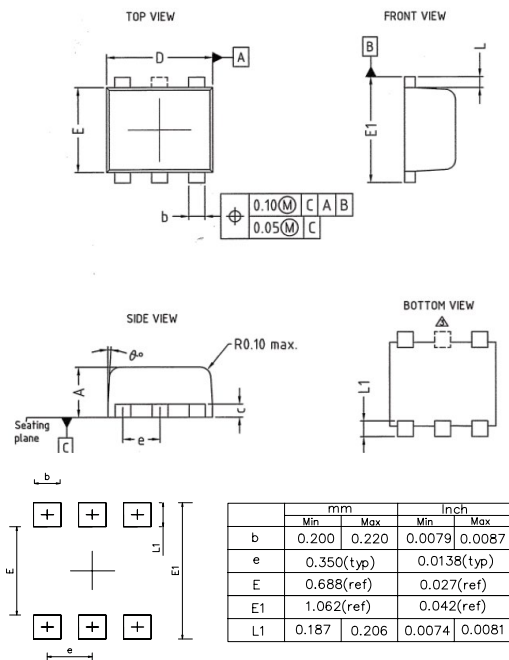

Package	SOT 963					
Pins	6					
	Millimeters			Inches		
	Min	Nom	Max	Min	Nom	Max
A	0.44	0.48	0.50	0.0173	0.0189	0.0197
B	0.10	0.15	0.20	0.004	0.006	0.008
c	0.05	0.10	0.15	0.002	0.004	0.006
D	0.95	1.00	1.05	0.037	0.039	0.041
E	0.75	0.80	0.85	0.029	0.031	0.033
E1	0.95	1.00	1.05	0.037	0.039	0.041
e	0.35 BSC			0.014 BSC		
L	0.05	0.10	0.15	0.002	0.004	0.006
L1	0.125	0.15	0.175	0.005	0.006	0.007
θ	3°	5°	7°	3°	5°	7°

SP1001 Series

8pF 15kV Unidirectional TVS Array

Embossed Carrier Tape & Reel Specification – SOT553 and SOT563

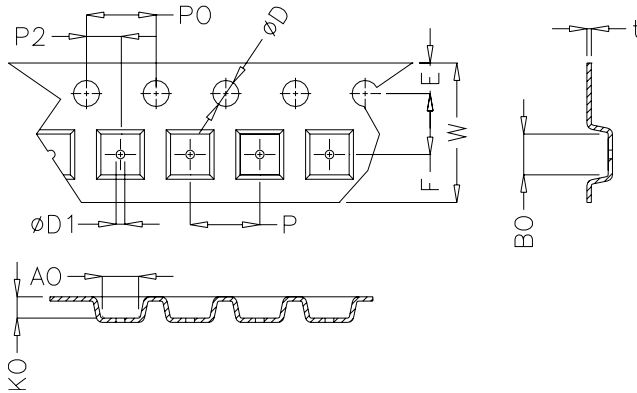

Symbol	Millimetres		Inches	
	Min	Max	Min	Max
E	1.65	1.85	0.065	0.073
F	3.45	3.55	0.135	0.139
P2	1.95	2.05	0.077	0.081
D	1.40	1.60	0.055	0.063
D1	0.45	0.55	0.017	0.021
P0	3.90	4.1	0.154	0.161
10P0	40.0 +/- 0.20		1.574 +/- 0.008	
W	7.70	8.10	0.303	0.318
P	3.90	4.10	0.153	0.161
A0	1.73	1.83	0.068	0.072
B0	1.73	1.83	0.068	0.072
K0	0.64	0.74	0.025	0.029
t	0.22 max		.009 max	

Embossed Carrier Tape & Reel Specification – SOT963

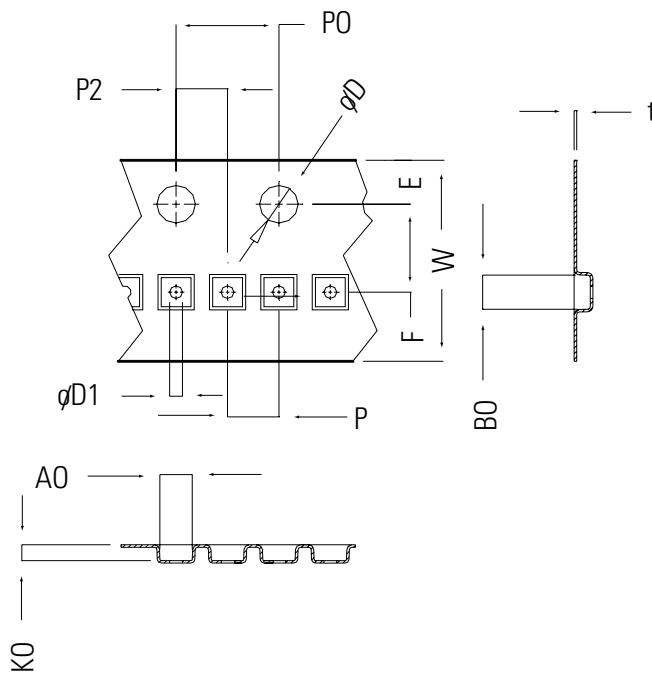

Symbol	Millimetres		Inches	
	Min	Max	Min	Max
E	1.65	1.85	0.065	0.073
F	3.45	3.55	0.136	0.140
D1	0.45	0.55	0.018	0.022
D	1.50 min		0.059 min	
P0	3.90	4.10	0.154	0.161
10P0	40.0 +/- 0.20		1.575 +/- 0.008	
P	1.95	2.05	0.077	0.081
P2	1.95	2.05	0.077	0.081
W	7.90	8.20	0.311	0.323
A0	1.11	1.21	0.044	0.048
B0	1.11	1.21	0.044	0.048
K0	0.58	0.68	0.023	0.027
t	0.22 max		0.009 max	

Disclaimer Notice - Information furnished is believed to be accurate and reliable. However, users should independently evaluate the suitability of and test each product selected for their own applications. Littelfuse products are not designed for, and may not be used in, all applications. Read complete Disclaimer Notice at <http://www.littelfuse.com/disclaimer-electronics>.