

GenX3™ 1200V IGBTs

IXGA30N120B3 IXGP30N120B3 IXGH30N120B3

High-Speed Low-V_{sat} PT IGBTs 3-20 kHz Switching

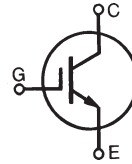

$V_{CES} = 1200V$
 $I_{C110} = 30A$
 $V_{CE(sat)} \leq 3.5V$
 $t_{fi(typ)} = 204ns$

Symbol	Test Conditions	Maximum Ratings	
V_{CES}	$T_C = 25^\circ C$ to $150^\circ C$	1200	V
V_{CGR}	$T_J = 25^\circ C$ to $150^\circ C$, $R_{GE} = 1M\Omega$	1200	V
V_{GES}	Continuous	± 20	V
V_{GEM}	Transient	± 30	V
I_{C25}	$T_C = 25^\circ C$	60	A
I_{C110}	$T_C = 110^\circ C$	30	A
I_{CM}	$T_C = 25^\circ C$, 1ms	150	A
SSOA (RBSOA)	$V_{GE} = 15V$, $T_{VJ} = 125^\circ C$, $R_G = 5\Omega$ Clamped Inductive Load	$I_{CM} = 60$ $V_{CE} \leq V_{CES}$	A
P_C	$T_C = 25^\circ C$	300	W
T_J		- 55 ... +150	$^\circ C$
T_{JM}		150	$^\circ C$
T_{stg}		- 55 ... +150	$^\circ C$
T_L	1.6mm (0.062 in.) from Case for 10s	300	$^\circ C$
T_{SOLD}	Plastic Body for 10 seconds	260	$^\circ C$
M_d	Mounting Torque (TO-220 & TO-247)	1.13/10	Nm/lb.in.
Weight	TO-263	2.5	g
	TO-220	3.0	g
	TO-247	6.0	g

TO-263 (IXGA)

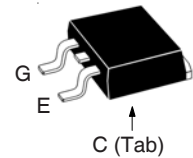

TO-220 (IXGP)

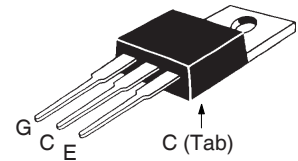

TO-247 (IXGH)

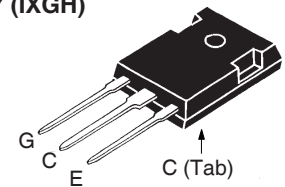

G = Gate C = Collector
E = Emitter Tab = Collector

Features

- Optimized for Low Conduction and Switching Losses
- Square RBSOA
- International Standard Packages

Advantages

- High Power Density
- Low Gate Drive Requirement

Applications

- Power Inverters
- UPS
- Motor Drives
- SMPS
- PFC Circuits
- Welding Machines

Symbol	Test Conditions ($T_J = 25^\circ C$, Unless Otherwise Specified)	Characteristic Values		
		Min.	Typ.	Max.
BV_{CES}	$I_C = 250\mu A$, $V_{GE} = 0V$	1200		V
$V_{GE(th)}$	$I_C = 250\mu A$, $V_{CE} = V_{GE}$	3.0		5.0 V
I_{CES}	$V_{CE} = V_{CES}$, $V_{GE} = 0V$ $T_J = 125^\circ C$			100 μA 1 mA
I_{GES}	$V_{CE} = 0V$, $V_{GE} = \pm 20V$			± 100 nA
$V_{CE(sat)}$	$I_C = 30A$, $V_{GE} = 15V$, Note 1 $T_J = 125^\circ C$	2.96 2.95		3.5 V V

Symbol	Test Conditions ($T_J = 25^\circ\text{C}$, Unless Otherwise Specified)	Characteristic Values		
		Min.	Typ.	Max.
g_{fs}	$I_C = 30\text{A}, V_{CE} = 10\text{V}$, Note 1	11	19	S
C_{ies}	$V_{CE} = 25\text{V}, V_{GE} = 0\text{V}, f = 1\text{MHz}$		1750	pF
C_{oes}			120	pF
C_{res}			46	pF
Q_g	$I_C = 30\text{A}, V_{GE} = 15\text{V}, V_{CE} = 0.5 \cdot V_{CES}$		87	nC
Q_{ge}			15	nC
Q_{gc}			39	nC
$t_{d(on)}$	Inductive load, $T_J = 25^\circ\text{C}$ $I_C = 30\text{A}, V_{GE} = 15\text{V}$ $V_{CE} = 0.8 \cdot V_{CES}, R_G = 5\Omega$ Notes 2		16	ns
t_{ri}			37	ns
E_{on}			3.47	mJ
$t_{d(off)}$			127	ns
t_{fi}			204	ns
E_{off}			2.16	mJ
$t_{d(on)}$	Inductive load, $T_J = 125^\circ\text{C}$ $I_C = 30\text{A}, V_{GE} = 15\text{V}$ $V_{CE} = 0.8 \cdot V_{CES}, R_G = 5\Omega$ Notes 2		18	ns
t_{ri}			38	ns
E_{on}			6.70	mJ
$t_{d(off)}$			216	ns
t_{fi}			255	ns
E_{off}			5.10	mJ
R_{thJC}	TO-220		0.42	$^\circ\text{C/W}$
R_{thCS}			0.50	$^\circ\text{C/W}$
R_{thCS}		TO-247	0.21	$^\circ\text{C/W}$

Notes:

1. Pulse test, $t \leq 300\mu\text{s}$, duty cycle, $d \leq 2\%$.
2. Switching times & energy losses may increase for higher V_{CE} (Clamp), T_J or R_G .

TO-263 (IXGA) Outline

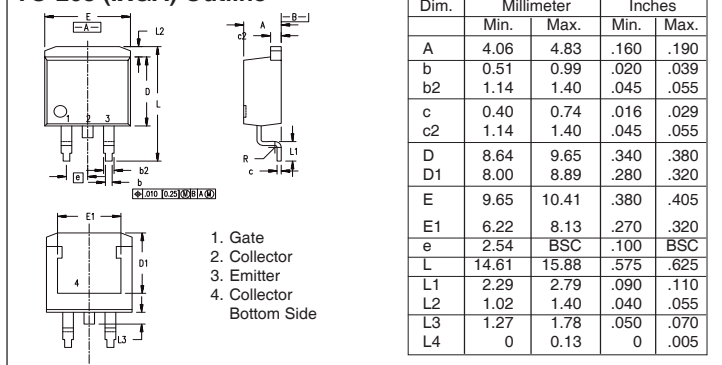

TO-220 (IXGP) Outline

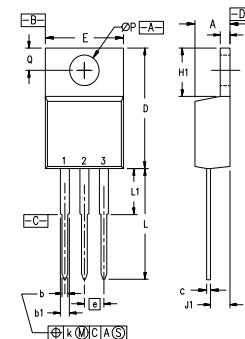

Pins: 1 - Gate 2 - Drain
3 - Source 4 - Drain

SYM	INCHES		MILLIMETERS	
	MIN	MAX	MIN	MAX
A	.170	.190	4.32	4.83
b	.025	.040	0.64	1.02
b1	.045	.065	1.15	1.65
c	.014	.022	0.35	0.56
D	.580	.630	14.73	16.00
E	.390	.420	9.91	10.66
e	.100 BSC		2.54 BSC	
F	.045	.055	1.14	1.40
H1	.230	.270	5.85	6.85
J1	.090	.110	2.29	2.79
k	0	.015	0	0.38
L	.500	.550	12.70	13.97
L1	.110	.230	2.79	5.84
ØP	.139	.161	3.53	4.08
Q	.100	.125	2.54	3.18

TO-247 (IXGH) AD Outline

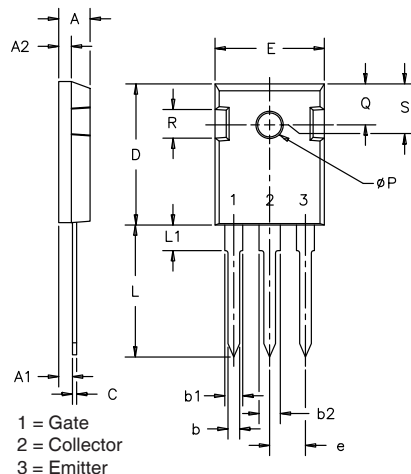

SYM	INCHES		MILLIMETERS	
	MIN	MAX	MIN	MAX
A	.185	.209	4.7	5.3
A1	.087	.102	2.2	2.54
A2	.059	.098	2.2	2.6
b	.040	.055	1.0	1.4
b1	.065	.084	1.65	2.13
b2	.113	.123	2.87	3.12
C	.016	.031	.4	.8
D	.819	.845	20.80	21.46
E	.610	.640	15.75	16.26
e	.215 BSC		5.45 BSC	
L	.780	.800	19.81	20.32
L1	.177		4.50	
ØP	.140	.144	3.55	3.65
Q	.212	.244	5.4	6.2
R	.170	.216	4.32	5.49
S	.242 BSC		6.15 BSC	

IXYS Reserves the Right to Change Limits, Test Conditions, and Dimensions.

IXYS MOSFETs and IGBTs are covered by one or more of the following U.S. patents:	4,835,592	4,931,844	5,049,961	5,237,481	6,162,665	6,404,065 B1	6,683,344	6,727,585	7,005,734 B2	7,157,338 B2
	4,850,072	5,017,508	5,063,307	5,381,025	6,259,123 B1	6,534,343	6,710,405 B2	6,759,692	7,063,975 B2	
	4,881,106	5,034,796	5,187,117	5,486,715	6,306,728 B1	6,583,505	6,710,463	6,771,478 B2	7,071,537	

Fig. 1. Output Characteristics @ $T_J = 25^\circ\text{C}$

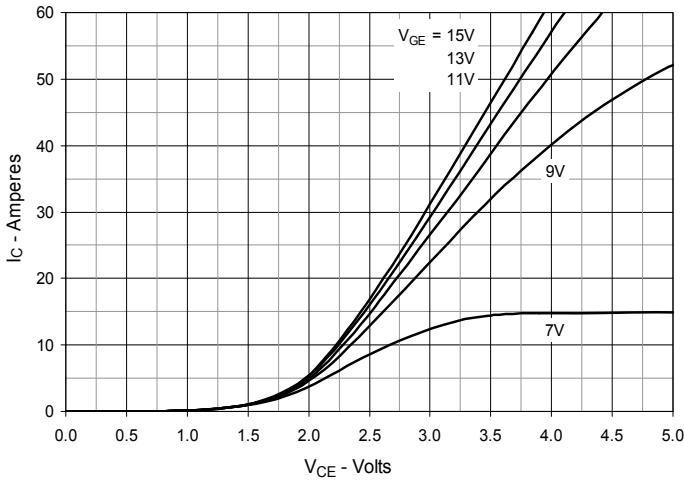

Fig. 2. Extended Output Characteristics @ $T_J = 25^\circ\text{C}$



Fig. 3. Output Characteristics @ $T_J = 125^\circ\text{C}$

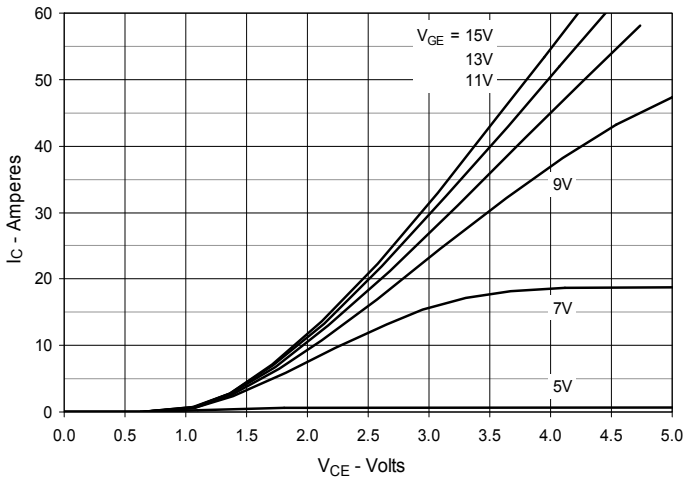

Fig. 4. Dependence of $V_{CE(sat)}$ on Junction Temperature

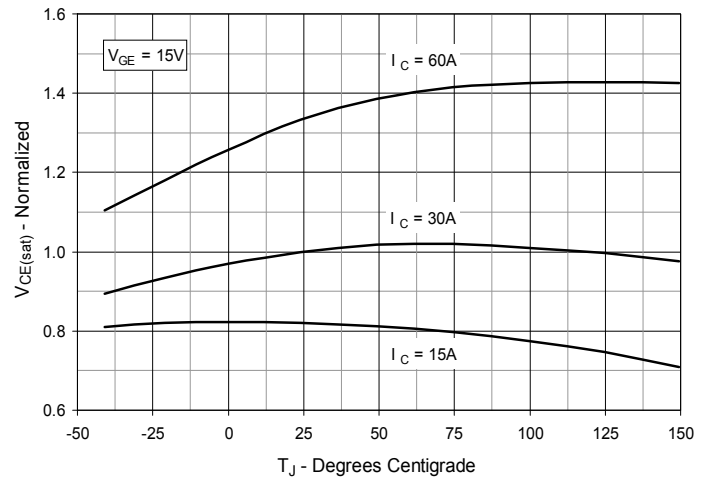

Fig. 5. Collector-to-Emitter Voltage vs. Gate-to-Emitter Voltage

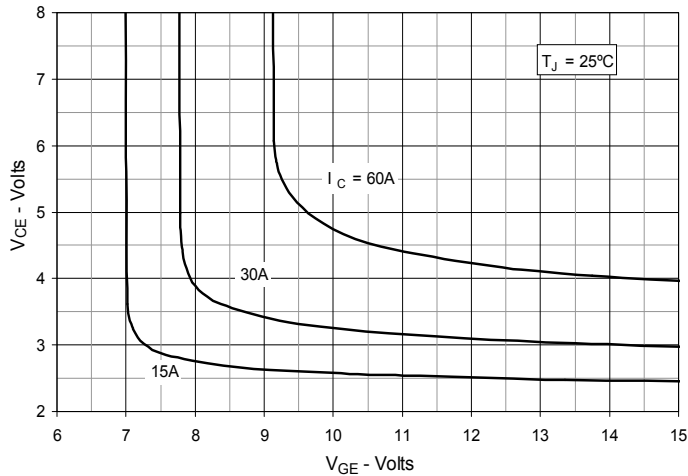

Fig. 6. Input Admittance



Fig. 7. Transconductance

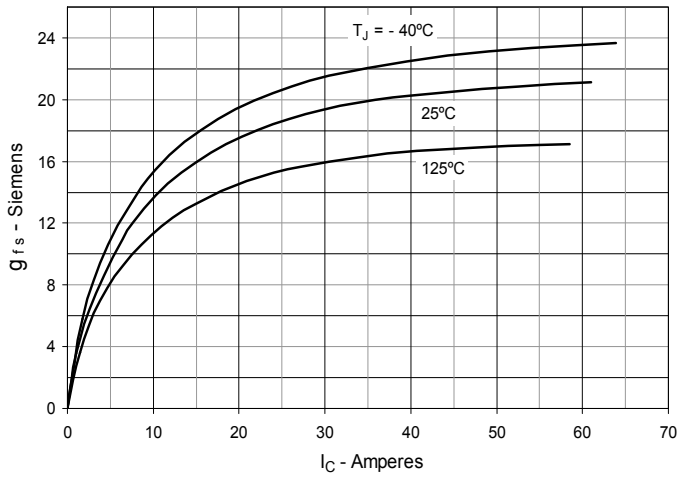

Fig. 8. Gate Charge

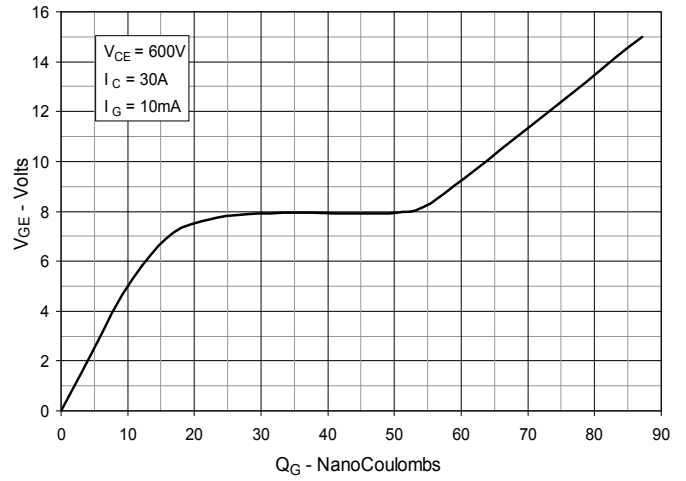

Fig. 9. Capacitance

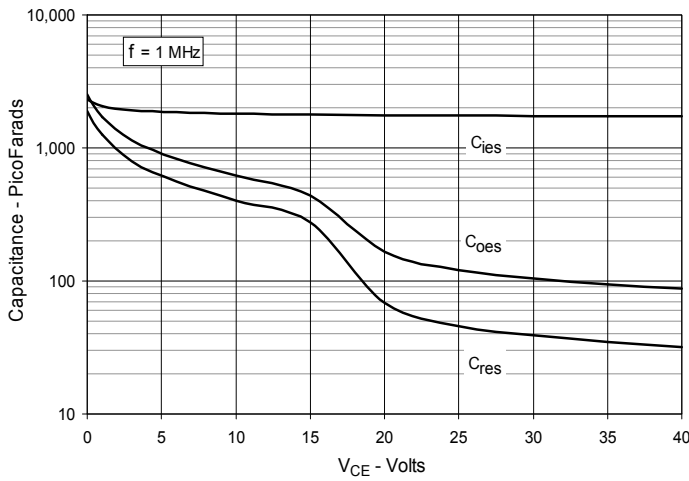

Fig. 10. Reverse-Bias Safe Operating Area

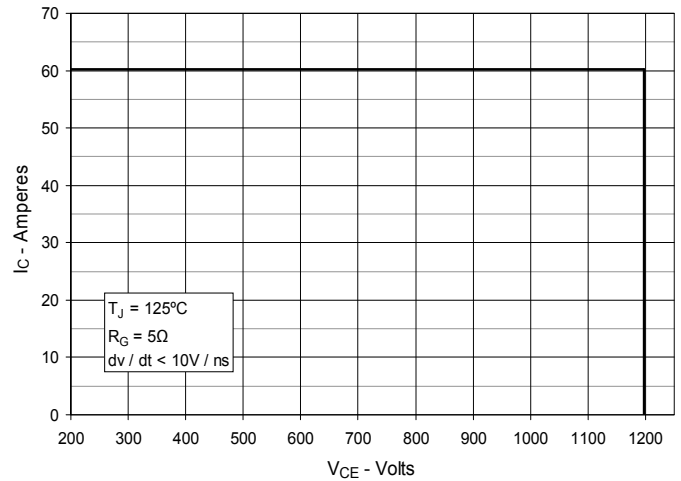
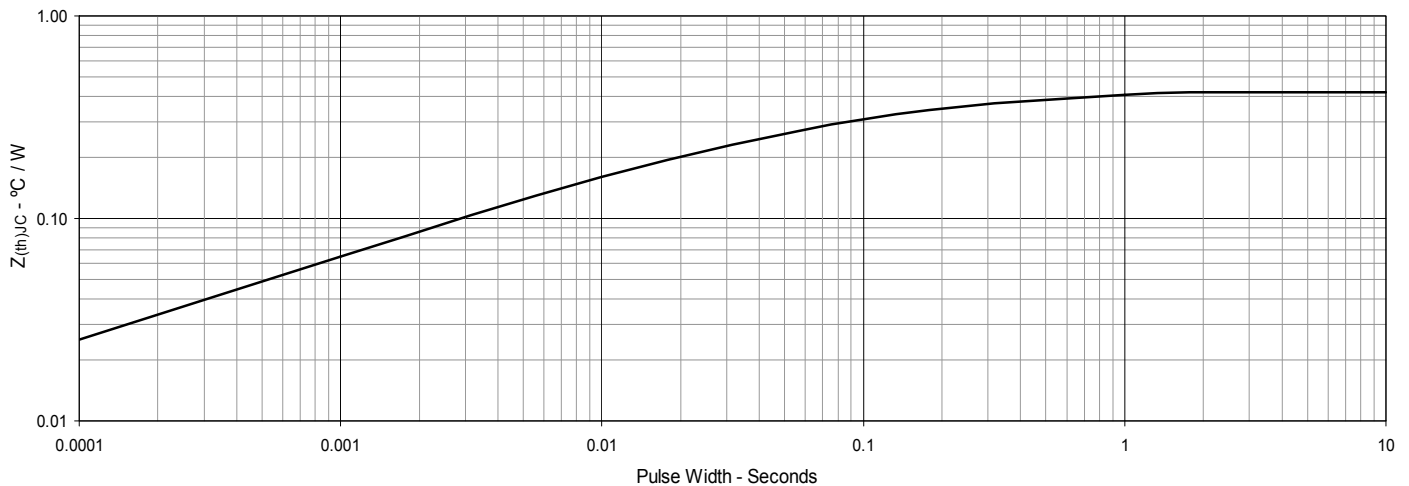
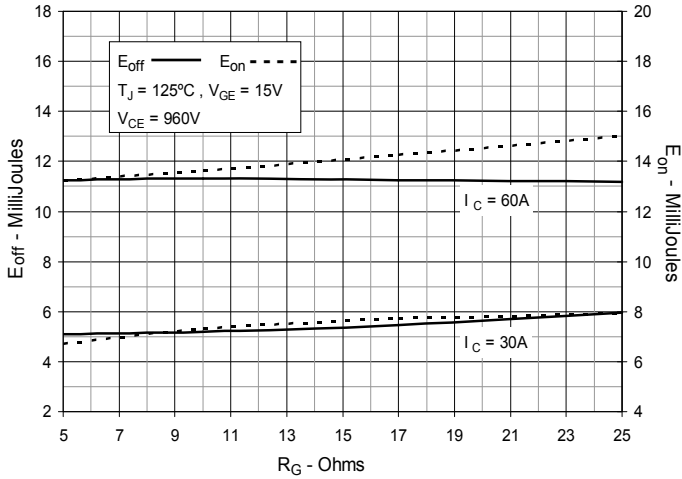

Fig. 11. Maximum Transient Thermal Impedance



**Fig. 12. Inductive Switching
Energy Loss vs. Gate Resistance**



**Fig. 13. Inductive Switching
Energy Loss vs. Collector Current**

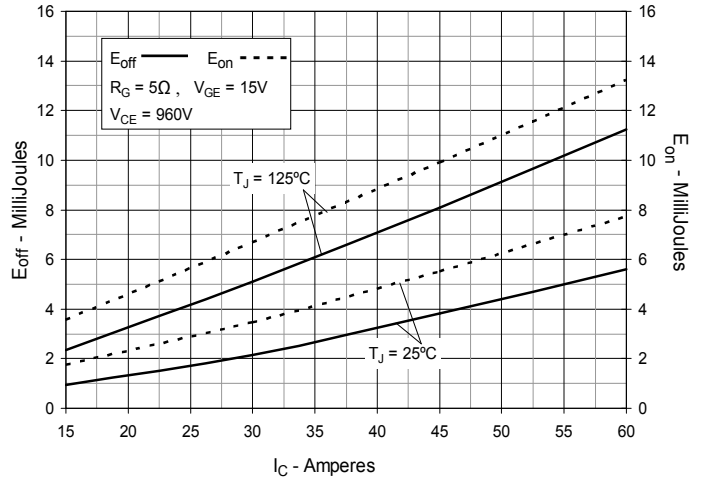

**Fig. 14. Inductive Switching
Energy Loss vs. Junction Temperature**

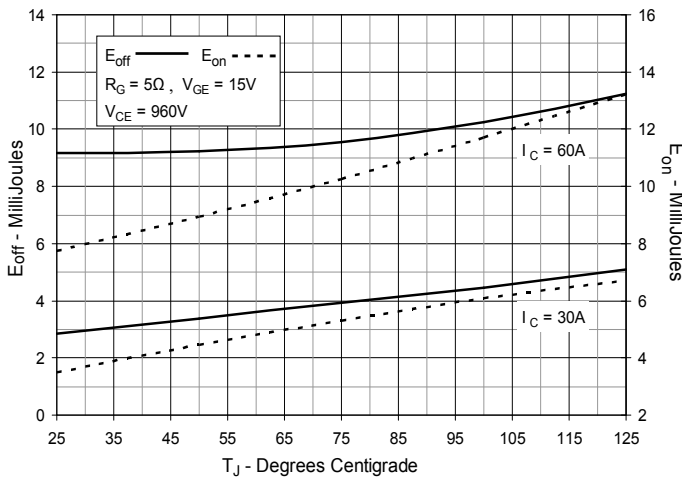

**Fig. 15. Inductive Turn-off
Switching Times vs. Gate Resistance**



**Fig. 16. Inductive Turn-off
Switching Times vs. Collector Current**

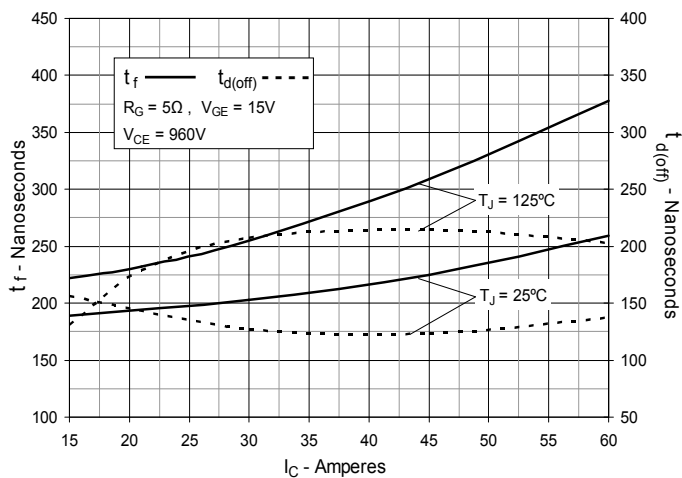

**Fig. 17. Inductive Turn-off
Switching Times vs. Junction Temperature**



**Fig. 18. Inductive Turn-on
Switching Times vs. Gate Resistance**

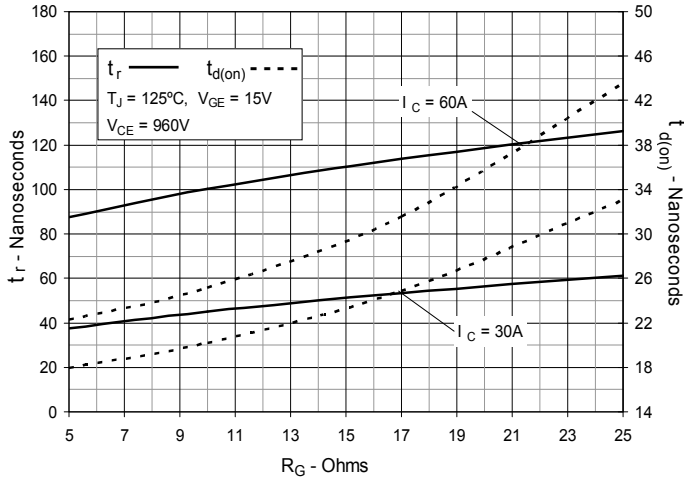

**Fig. 19. Inductive Turn-on
Switching Times vs. Collector Current**

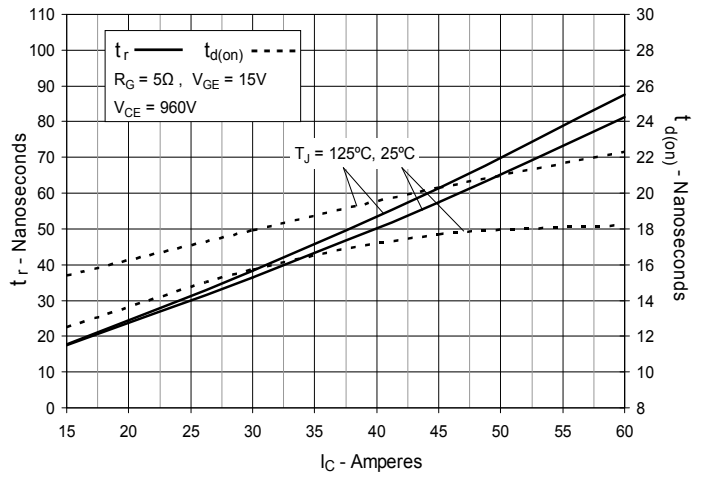

**Fig. 20. Inductive Turn-on
Switching Times vs. Junction Temperature**





Disclaimer Notice - Information furnished is believed to be accurate and reliable. However, users should independently evaluate the suitability of and test each product selected for their own applications. Littelfuse products are not designed for, and may not be used in, all applications. Read complete Disclaimer Notice at www.littelfuse.com/disclaimer-electronics.