

# AQ1003-01ETG Series

## General Purpose ESD Protection

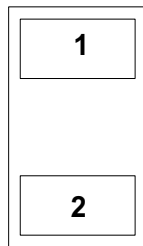

### Pinout



### Functional Block Diagram

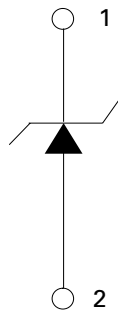

### Description

This TVS diode is fabricated in a proprietary silicon avalanche technology that offers each I/O pin a high level of protection for electronic equipment that may experience destructive electrostatic discharges (ESD). These robust TVS diodes can safely absorb repetitive ESD strikes at  $\pm 30\text{kV}$  (contact discharge, IEC 61000-4-2) without performance degradation. Additionally, the TVS diode can safely dissipate 7A of 8/20 $\mu\text{s}$  surge current (IEC 61000-4-5 2nd Edition) with very low clamping voltages.

### Features

- ESD, IEC 61000-4-2,  $\pm 30\text{kV}$  contact,  $\pm 30\text{kV}$  air
- EFT, IEC 61000-4-4, 40A (5/50ns)
- Lightning, 7A (8/20 $\mu\text{s}$  as defined in IEC 61000-4-5 2nd edition)
- Low leakage current of 100nA (MAX) at 5V
- PPAP Capable
- Small SOD882 (JEDEC MO-236) package saves board space
- Fits solder footprint of industry standard 0402 (1005) components
- AEC-Q101 qualified
- Halogen free, Lead free and RoHS compliant
- Moisture Sensitivity Level(MSL -1)
- ESD, ISO 10605, 330pF 330 $\Omega$ ,  $\pm 29\text{kV}$  contact,  $\pm 30\text{kV}$  air

### Applications

- Mobile phones
- Smart phones
- PDAs
- Portable navigation components
- Digital cameras
- Portable medical components
- Automotive applications

### Application Example

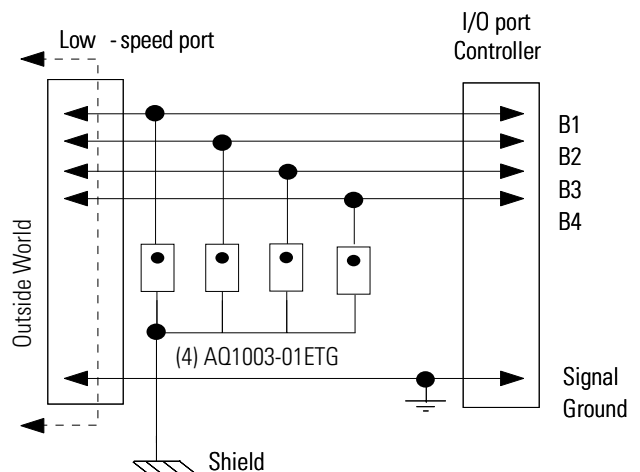

Life Support Note:  
**Not Intended for Use in Life Support or Life Saving Applications**  
 The products shown herein are not designed for use in life sustaining or life saving applications unless otherwise expressly indicated.

# AQ1003-01ETG Series

## General Purpose ESD Protection

### Absolute Maximum Ratings

Symbol	Parameter	Value	Units
$I_{PP}$	Peak Pulse Current ( $t_p=8/20\mu s$ )	7.0	A
$T_{OP}$	Operating Temperature	-40 to 150	°C
$T_{STOR}$	Storage Temperature	-55 to 150	°C

**Caution:** Stresses above those listed in "Absolute Maximum Ratings" may cause permanent damage to the component. This is a stress only rating and operation of the component at these or any other conditions above those indicated in the operational sections of this specification is not implied.

### Electrical Characteristics ( $T_{OP}=25^\circ C$ )

Parameter	Symbol	Test Conditions	Min	Typ	Max	Units
Forward Voltage Drop	$V_F$	$I_F = 10mA$		0.8	1.2	V
Breakdown Voltage	$V_{BR}$	$I_R = 1mA$	6.0	7.8	8.5	V
Reverse Standoff Voltage	$V_{RWM}$	$I_R = 1\mu A$			5.0	V
Reverse Leakage Current	$I_{LEAK}$	$V_R = 5V$			100	nA
Clamp Voltage <sup>1</sup>	$V_C$	$I_{PP} = 6A$ $t_p = 8/20\mu s$		11.4		V
		$I_{PP} = 7A$ $t_p = 8/20\mu s$		12.0		V
Dynamic Resistance <sup>2</sup>	$R_{DYN}$	TLP, $t_p = 100ns$ , I/O to GND		0.25		$\Omega$
ESD Voltage <sup>1</sup>	$V_{ESD}$	IEC 61000-4-2 (Contact Discharge)	$\pm 30$			kV
		IEC 61000-4-2 (Air Discharge)	$\pm 30$			kV
Diode Capacitance <sup>1</sup>	$C_{I/O-GND}$	Reverse Bias=0V $f=1MHz$		30		pF

**Note:** 1 Parameter is guaranteed by design and/or component characterization.

2 Transmission Line Pulse (TLP) with 100ns width, 2ns rise time, and average window  $t_1=70ns$  to  $t_2=90ns$

### Capacitance vs. Reverse Bias

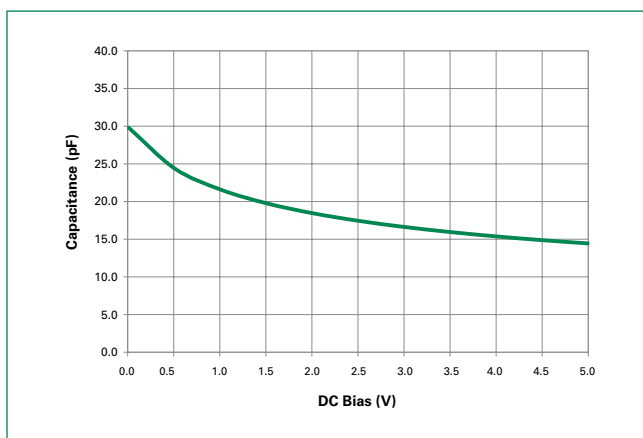

### Clamping Voltage vs. $I_{PP}$

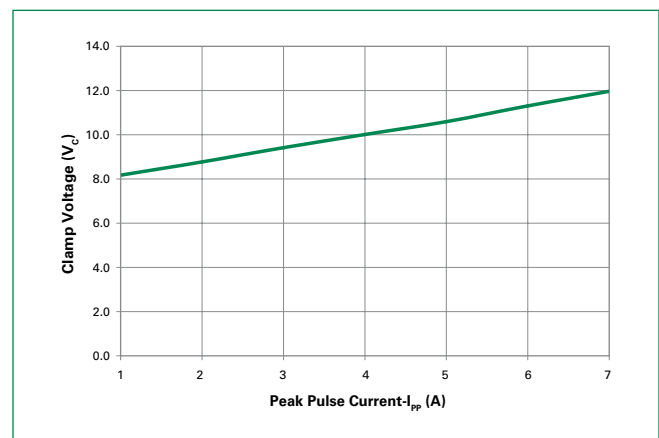

# AQ1003-01ETG Series

## General Purpose ESD Protection

Transmission Line Pulsing(TLP) Plot

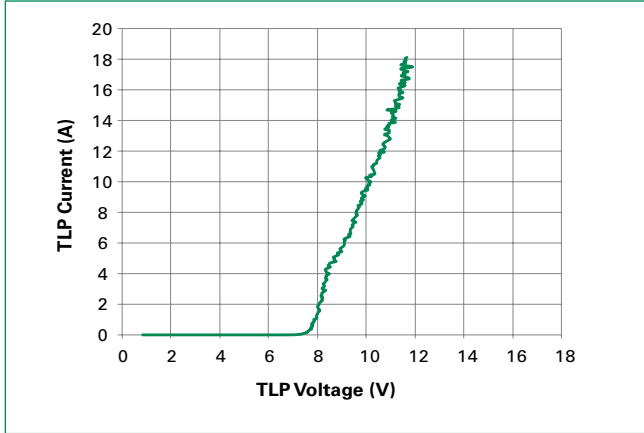

Leakage vs. Temperature

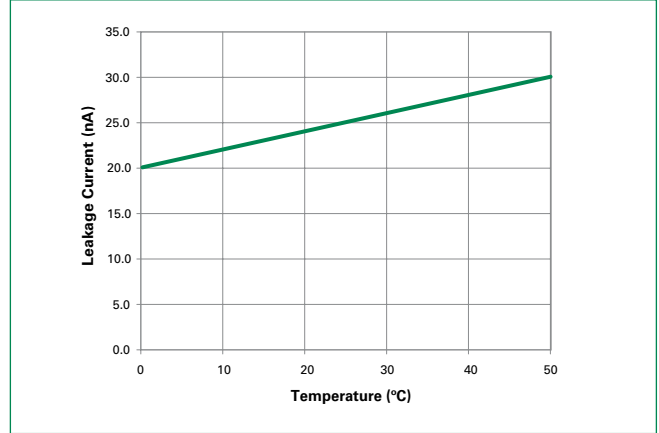

8/20µs Pulse Waveform

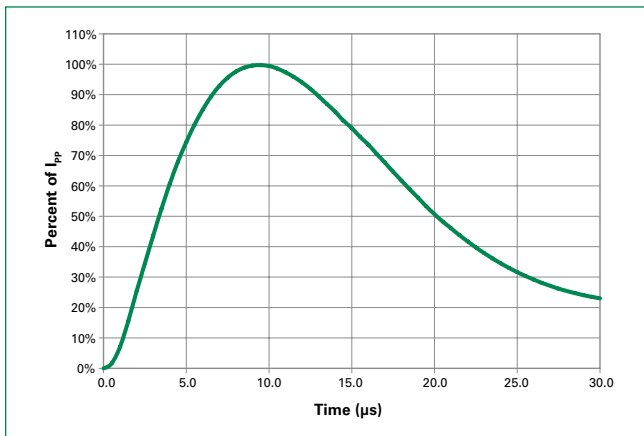

ISO10605 (C:330pF, R:330Ω) contact discharge plot at +8KV

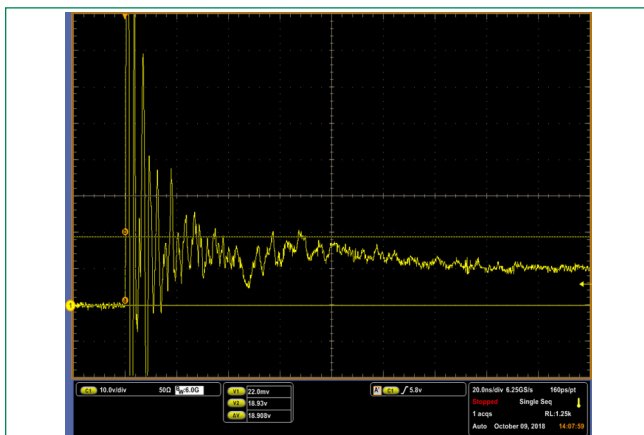

ISO10605 (C:330pF, R:330Ω) contact discharge plot at -8KV

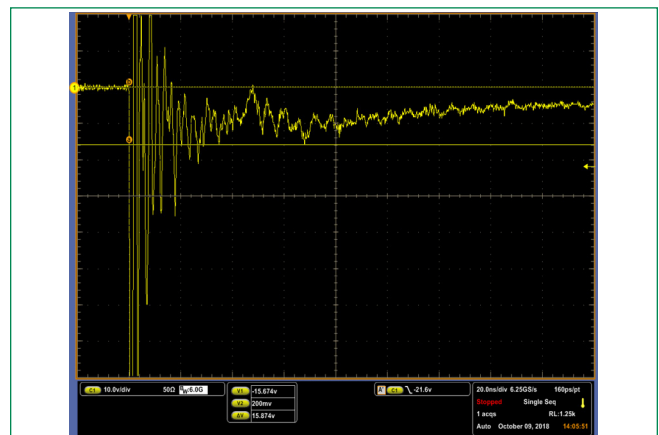

# AQ1003-01ETG Series

## General Purpose ESD Protection

### Soldering Parameters

<b>Reflow Condition</b>		Pb – Free assembly
<b>Pre Heat</b>	- Temperature Min ( $T_{s(min)}$ )	150°C
	- Temperature Max ( $T_{s(max)}$ )	200°C
	- Time (min to max) ( $t_s$ )	60 – 120 secs
<b>Average ramp up rate (Liquidus) Temp (<math>T_L</math>) to peak</b>		3°C/second max
<b><math>T_{s(max)}</math> to <math>T_L</math> - Ramp-up Rate</b>		3°C/second max
<b>Reflow</b>	- Temperature ( $T_L$ ) (Liquidus)	217°C
	- Temperature ( $t_L$ )	60 – 150 seconds
<b>Peak Temperature (<math>T_p</math>)</b>		260 <sup>+0/-5</sup> °C
<b>Time within 5°C of actual peak Temperature (<math>t_p</math>)</b>		30 seconds
<b>Ramp-down Rate</b>		6°C/second max
<b>Time 25°C to peak Temperature (<math>T_p</math>)</b>		8 minutes Max.
<b>Do not exceed</b>		260°C

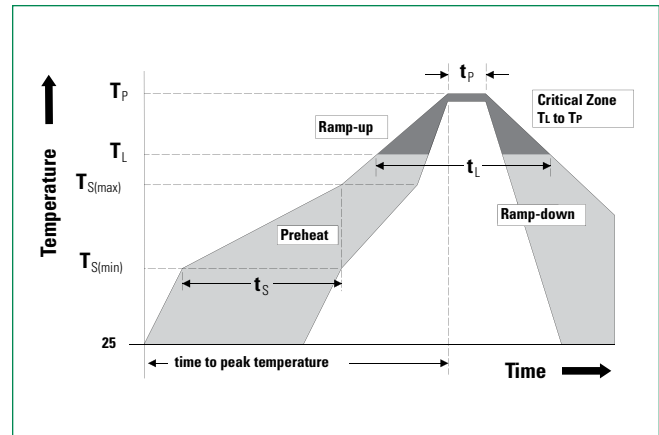

### Part Numbering System

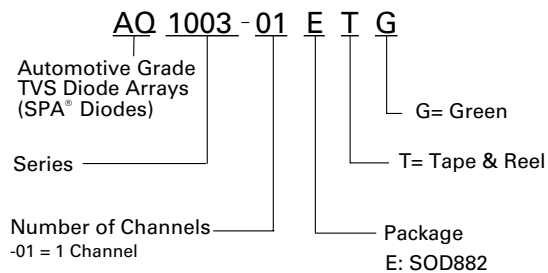

### Product Characteristics

<b>Lead Plating</b>	Pre-Plated Frame
<b>Lead Material</b>	Copper Alloy
<b>Substrate material</b>	Silicon
<b>Body Material</b>	Molded Compound
<b>Flammability</b>	UL Recognized compound meeting flammability rating V-0

### Part Marking System

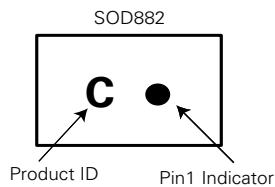

### Ordering Information

Part Number	Package	Min. Order Qty.
AQ1003-01ETG	SOD882	10000

# AQ1003-01ETG Series

## General Purpose ESD Protection

### Package Dimensions — SOD882

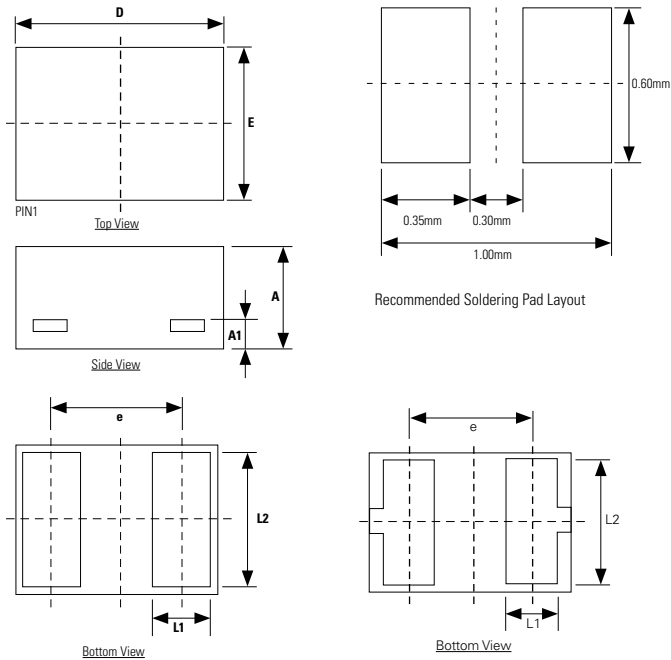

Symbol	DIMENSIONS (mm)		
	Min.	Nor.	Max.
A	0.36	0.45	0.55
A1	0.127 REF		
L1	0.20	0.25	0.30
L2	0.45	0.50	0.55
D	0.93	1.00	1.07
E	0.53	0.60	0.67
e	0.65 BSC		
h	0.07	0.12	0.17

### Embossed Carrier Tape & Reel Specification — SOD882

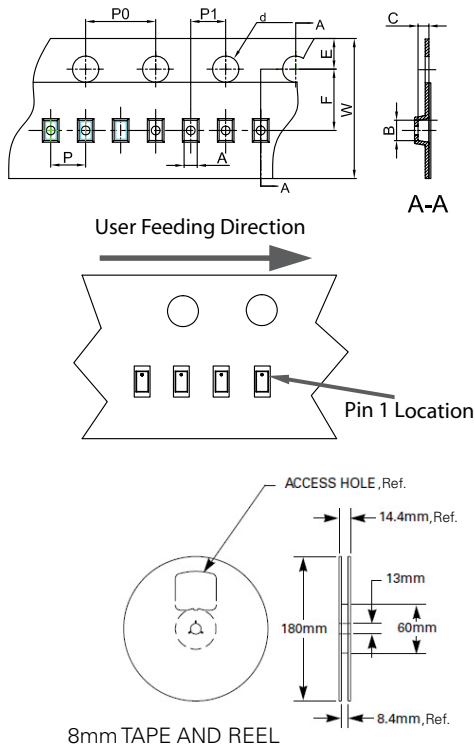

Symbol	Millimetres		Inches	
	Min	Max	Min	Max
A	0.65	0.70	0.026	0.028
B	1.10	1.20	0.043	0.047
C	0.50	0.60	0.020	0.024
d $\varnothing$	1.40	1.60	0.055	0.063
E	1.65	1.85	0.065	0.073
F	3.40	3.60	0.134	0.142
P0	3.90	4.10	0.154	0.161
P	1.90	2.10	0.075	0.083
P1	1.90	2.10	0.075	0.083
W	7.90	8.10	0.311	0.319

**Disclaimer Notice** - Information furnished is believed to be accurate and reliable. However, users should independently evaluate the suitability of and test each product selected for their own applications. Littelfuse products are not designed for, and may not be used in, all applications. Read complete Disclaimer Notice at <http://www.littelfuse.com/disclaimer-electronics>.