

**SP3222 0.9pF 30kV dual channel TVS**

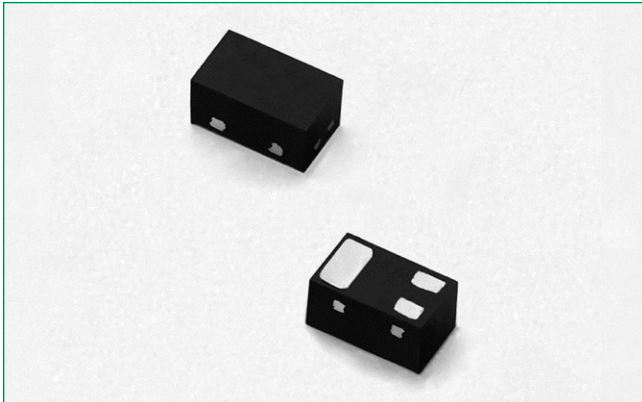

**Pinout**

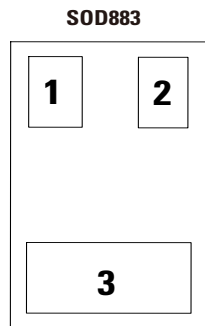

**Bottom View**

**Functional Block Diagram**

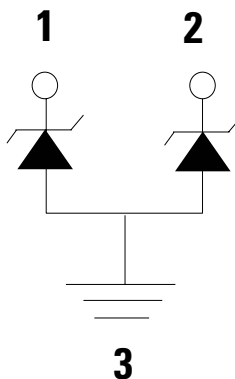

Life Support Note:

**Not Intended for Use in Life Support or Life Saving Applications**

The products shown herein are not designed for use in life sustaining or life saving applications unless otherwise expressly indicated.

**Description**

The SP3222 integrates 2 channels of low capacitance diodes to provide protection for electronic equipment that may experience destructive electrostatic discharges (ESD). These robust diodes can safely absorb repetitive ESD strikes above the maximum level specified in the IEC 61000-4-2 international standard ( $\pm 30\text{kV}$  contact discharge) without performance degradation. The low loading capacitance makes it ideal for protecting high speed data lines such as DVI, USB2.0, USB3.0 and eSATA.

**Features**

- ESD protection of  $\pm 30\text{kV}$  contact discharge,  $\pm 30\text{kV}$  air discharge, (IEC 61000-4-2)
- EFT, IEC 61000-4-4, 40A (5/50ns)
- Lightning protection, IEC 61000-4-5 2<sup>nd</sup> edition, 3A ( $t_p=8/20\mu\text{s}$ )
- Low capacitance of 0.9pF @  $V_R=0\text{V}$  (MAX)
- Space efficient 0402 (SOD883) footprint
- Extremely low dynamic resistance (0.17 $\Omega$  TYP)
- Moisture Sensitivity Level (MSL -1)
- Halogen free, Lead free and RoHS compliant
- AEC-Q101 qualified

**Applications**

- USB 3.0/USB 2.0/MHL
- MIPI Camera and Display
- DisplayPort 1.3, eSATA
- Set Top Boxes, Game Consoles
- Smart Phones
- External Storage
- Ultrabooks, Notebooks
- Tablets, eReaders
- High Speed Serial Interfaces

**Applications Example**

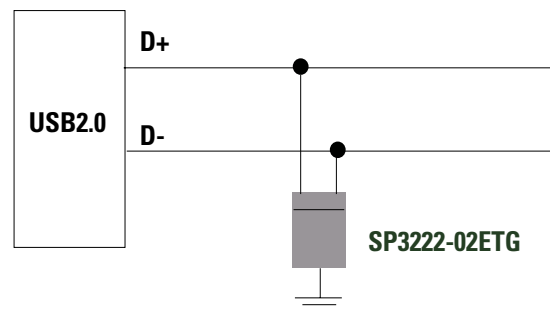

### Absolute Maximum Ratings

Symbol	Parameter	Value	Units
$P_{PK}$	Peak Pulse Power ( $t_p=8/20\mu s$ )	30	W
$I_{PP}$	Peak Current ( $t_p=8/20\mu s$ )	3.0	A
$T_{OP}$	Operating Temperature	-40 to 125	°C

**CAUTION:** Stresses above those listed in "Absolute Maximum Ratings" may cause permanent damage to the component. This is a stress only rating and operation of the component at these or any other conditions above those indicated in the operational sections of this specification is not implied.

### Electrical Characteristics ( $T_{OP}=25^\circ C$ )

Parameter	Symbol	Test Conditions	Min	Typ	Max	Units
Reverse Standoff Voltage	$V_{RWM}$				3.3	V
Forward Bias				-0.9	-0.7	V
Breakdown Voltage	$V_{BR}$	$I_R=1mA$	6.1	8.0	9.0	V
Reverse Leakage Current	$I_{LEAK}$	$V_R=3.3V$		0.01	0.1	$\mu A$
Clamp Voltage <sup>1</sup>	$V_C$	$I_{PP}=3A, t_p=8/20\mu s, Fwd$		10		V
Dynamic Resistance <sup>2</sup>	$R_{DYN}$	TLP, $t_p=100ns, I/O$ to GND		0.17		$\Omega$
ESD Withstand Voltage <sup>1</sup>	$V_{ESD}$	IEC 61000-4-2 (Contact)	$\pm 30$			kV
		IEC 61000-4-2 (Air)	$\pm 30$			kV
Diode Capacitance <sup>1</sup>	$C_D$	Reverse Bias=0V			0.9	pF

**Note:**

- Parameter is guaranteed by design and/or component characterization.
- Transmission Line Pulse (TLP) with 100ns width, 200ps rise time, and average window  $t_1=70ns$  to  $t_2=90ns$

### 8/20 $\mu s$ Pulse Waveform

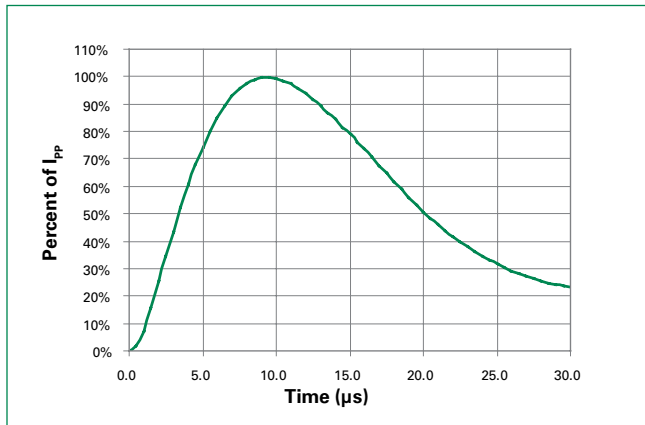

### Clamping Voltage vs $I_{PP}$

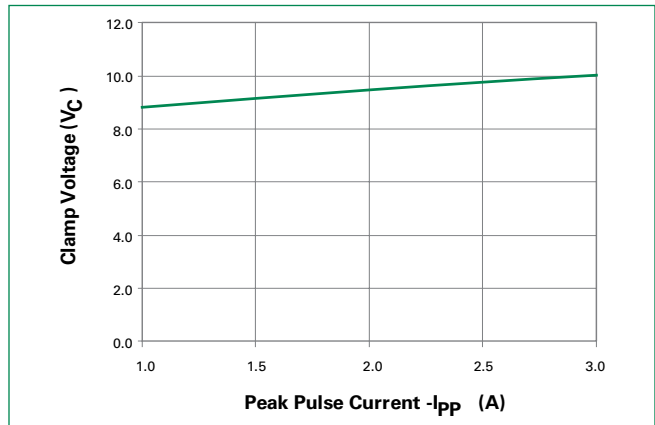

**Positive Transmission Line Pulsing (TLP) Plot**

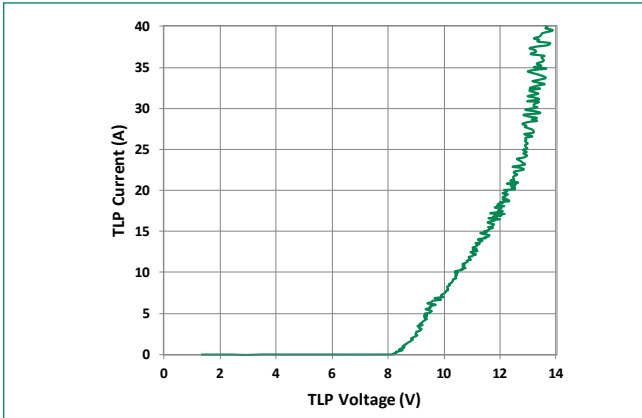

**Negative Transmission Line Pulsing (TLP) Plot**

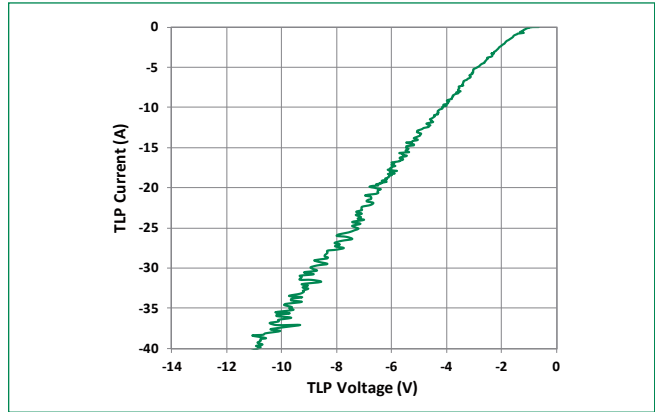

**IEC 61000-4-2 +8 kV Contact ESD Clamping Voltage**

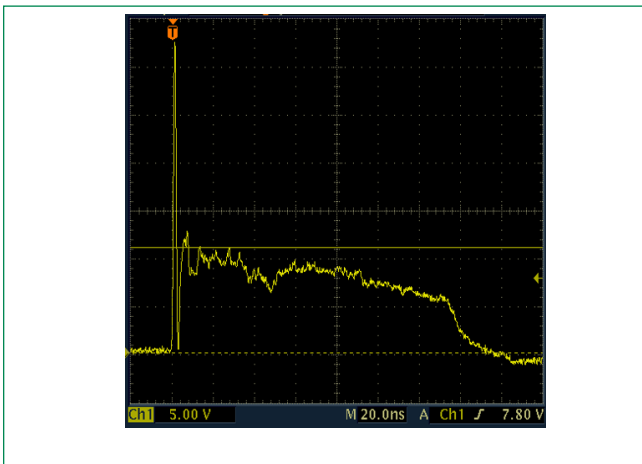

**IEC 61000-4-2 -8 kV Contact ESD Clamping Voltage**

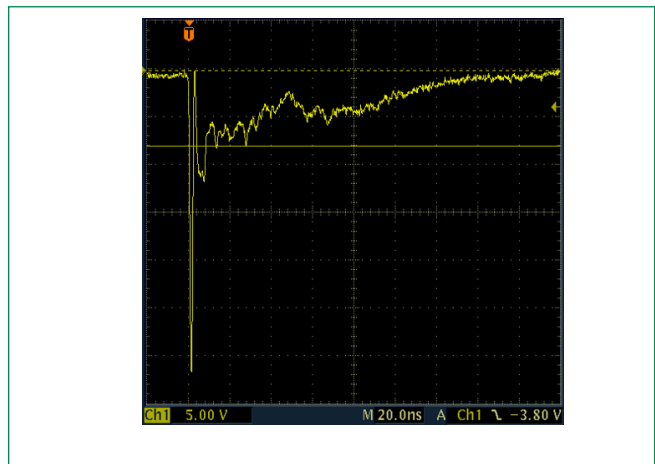

**Soldering Parameters**

<b>Reflow Condition</b>		Pb - Free assembly
<b>Pre Heat</b>	- Temperature Min ( $T_{s(min)}$ )	150°C
	- Temperature Max ( $T_{s(max)}$ )	200°C
	- Time (min to max) ( $t_p$ )	60 - 180 secs
<b>Average ramp up rate (Liquidus) Temp (<math>T_L</math>) to peak</b>		3°C/second max
<b><math>T_{s(max)}</math> to <math>T_L</math> - Ramp-up Rate</b>		3°C/second max
<b>Reflow</b>	- Temperature ( $T_L$ ) (Liquidus)	217°C
	- Temperature ( $t_L$ )	60 - 150 seconds
<b>Peak Temperature (<math>T_p</math>)</b>		260 <sup>+0/-5</sup> °C
<b>Time within 5°C of actual peak Temperature (<math>t_p</math>)</b>		20 - 40 seconds
<b>Ramp-down Rate</b>		6°C/second max
<b>Time 25°C to peak Temperature (<math>T_p</math>)</b>		8 minutes Max.
<b>Do not exceed</b>		260°C

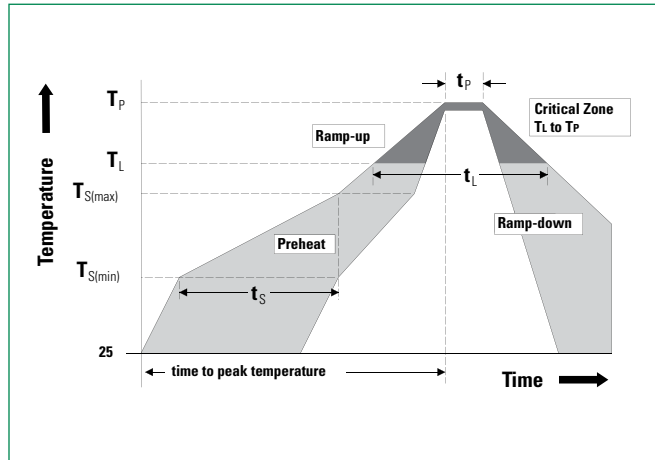

**Package Dimensions – SOD883**

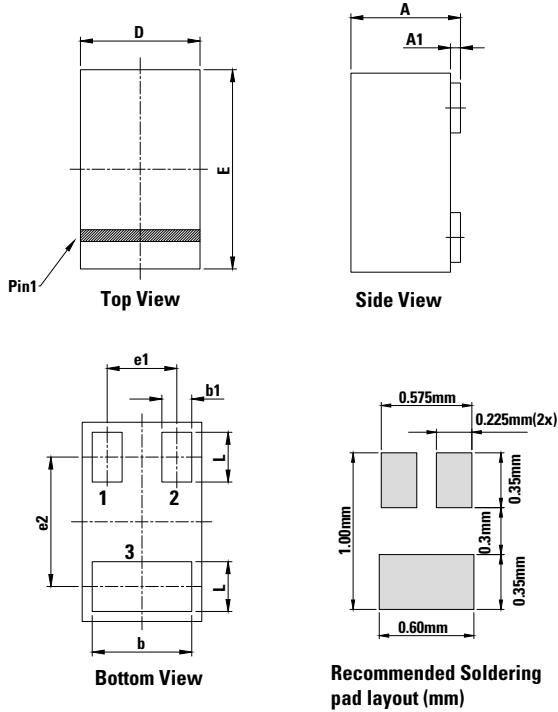

Symbol	Millimeters			Inches		
	Min	Typ	Max	Min	Typ	Max
A	0.45	0.50	0.55	0.018	0.020	0.022
A1	-	0.02	0.05	-	0.001	0.002
D	0.55	0.60	0.65	0.022	0.024	0.026
E	0.95	1.00	1.05	0.037	0.039	0.041
b	0.45	0.55	0.60	0.018	0.022	0.024
b1	0.10	0.15	0.20	0.004	0.006	0.008
L	0.20	0.25	0.30	0.008	0.010	0.012
e1	0.35 BSC			0.014 BSC		
e2	0.65 BSC			0.026 BSC		

**Part Marking System**

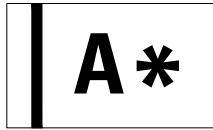

**Part Code(A) = SP3222-02ETG**  
**\* = Date code**

**Part Numbering System**

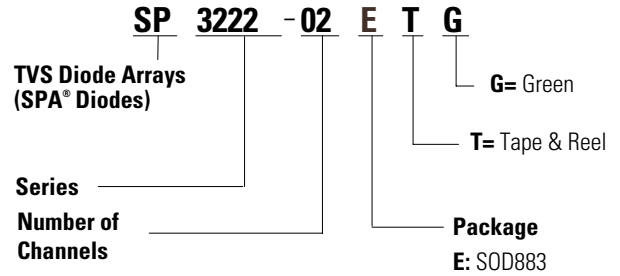

**Ordering Information**

Part Number	Package	Min. Order Qty.
SP3222-02ETG	SOD883	10000

**Embossed Carrier Tape & Reel Specification – SOD883**

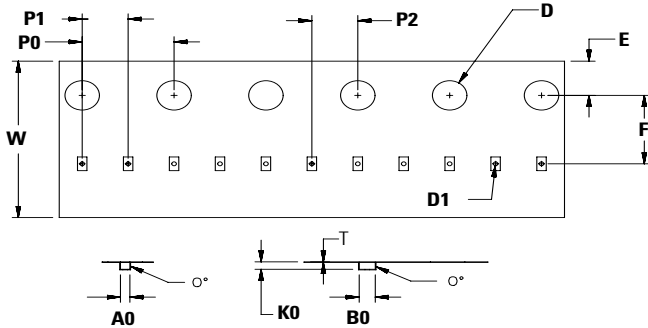

Symbol	Millimeters
A0	0.70+/-0.05
B0	1.15+/-0.05
D	∅ 1.50 + 0.10
D1	∅ 1.55 +/- 0.05
E	1.75+/-0.10
F	3.50+/-0.05
K0	0.47+/-0.05
P0	4.00+/-0.10
P1	2.00+/-0.05
P2	2.00+/-0.05
W	8.00 + 0.30 -0.10
T	0.20+/-0.05

**8mm TAPE AND REEL**

