

**High Voltage
IGBTs**
**IXGH24N170A
IXGT24N170A**

$V_{CES} = 1700V$

$I_{C25} = 24A$

$V_{CE(sat)} \leq 6.0V$

$t_{fi(typ)} = 40ns$

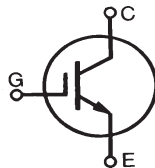

Symbol	Test Conditions	Maximum Ratings	
V_{CES}	$T_C = 25^\circ C$ to $150^\circ C$	1700	V
V_{CGR}	$T_J = 25^\circ C$ to $150^\circ C$, $R_{GE} = 1M\Omega$	1700	V
V_{GES}	Continuous	± 20	V
V_{GEM}	Transient	± 30	V
I_{C25}	$T_C = 25^\circ C$	24	A
I_{C90}	$T_C = 90^\circ C$	16	A
I_{CM}	$T_C = 25^\circ C$, 1ms	75	A
SSOA (RBSOA)	$V_{GE} = 15V$, $T_{VJ} = 125^\circ C$, $R_G = 10\Omega$ Clamped Inductive Load	$I_{CM} = 50$ $0.8 \cdot V_{CES}$	A V
t_{sc}	$T_J = 125^\circ C$, $V_{CE} = 1200V$, $V_{GE} = 15V$, $R_G = 22\Omega$	10	μs
P_C	$T_C = 25^\circ C$	250	W
T_J		-55 ... +150	$^\circ C$
T_{JM}		150	$^\circ C$
T_{stg}		-55 ... +150	$^\circ C$
T_L	1.6mm (0.062 in.) from Case for 10s	300	$^\circ C$
T_{SOLD}	Plastic Body for 10 seconds	260	$^\circ C$
M_d	Mounting Torque (TO-247)	1.13/10	Nm/lb.in.
Weight	TO-247	6	g
	TO-268	4	g

TO-247 (IXGH)

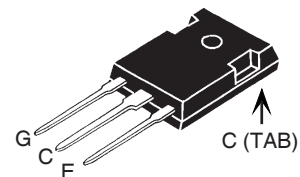

TO-268 (IXGT)

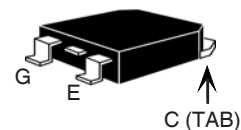

G = Gate C = Collector
E = Emitter TAB = Collector

Features

- Optimized for Low Conduction and Switching Losses
- International Standard Packages

Advantages

- High Power Density
- Low Gate Drive Requirement

Applications

- Power Inverters
- UPS
- Motor Drives
- SMPS
- PFC Circuits
- Welding Machines

Symbol	Test Conditions ($T_J = 25^\circ C$ Unless Otherwise Specified)	Characteristic Values		
		Min.	Typ.	Max.
BV_{CES}	$I_C = 250\mu A$, $V_{GE} = 0V$	1700		V
$V_{GE(th)}$	$I_C = 250\mu A$, $V_{CE} = V_{GE}$	3.0		V
I_{CES}	$V_{CE} = 0.8 \cdot V_{CES}$, $V_{GE} = 0V$ $T_J = 125^\circ C$			50 μA 1 mA
I_{GES}	$V_{CE} = 0V$, $V_{GE} = \pm 20V$			± 100 nA
$V_{CE(sat)}$	$I_C = 16A$, $V_{GE} = 15V$, Note 1 $T_J = 125^\circ C$		4.5 4.8	V V

Symbol	Test Conditions ($T_J = 25^\circ\text{C}$, Unless Otherwise Specified)	Characteristic Values		
		Min.	Typ.	Max.
g_{fs}	$I_C = 24\text{A}$, $V_{CE} = 10\text{V}$, Note 2	13	22	S
C_{ies}	$V_{CE} = 25\text{V}$, $V_{GE} = 0\text{V}$, $f = 1\text{MHz}$		2860	pF
C_{oes}			198	pF
C_{res}			58	pF
Q_g	$I_C = 16\text{A}$, $V_{GE} = 15\text{V}$, $V_{CE} = 0.5 \cdot V_{CES}$		140	nC
Q_{ge}			18	nC
Q_{gc}			60	nC
$t_{d(on)}$	Inductive Load, $T_J = 25^\circ\text{C}$ $I_C = 24\text{A}$, $V_{GE} = 15\text{V}$ $V_{CE} = 0.5 \cdot V_{CES}$, $R_G = 10\Omega$ Note 1		21	ns
t_{ri}			36	ns
E_{on}			2.97	mJ
$t_{d(off)}$			336	ns
t_{fi}			40	80 ns
E_{off}			0.79	1.50 mJ
$t_{d(on)}$	Inductive Load, $T_J = 125^\circ\text{C}$ $I_C = 24\text{A}$, $V_{GE} = 15\text{V}$ $V_{CE} = 0.5 \cdot V_{CES}$, $R_G = 10\Omega$ Note 1		23	ns
t_{ri}			31	ns
E_{on}			3.60	mJ
$t_{d(off)}$			360	ns
t_{fi}			96	ns
E_{off}			1.47	mJ
R_{thJC}				0.50 $^\circ\text{C/W}$
R_{thCK}		0.25		$^\circ\text{C/W}$

- Notes:
- Switching times may increase for V_{CE} (Clamp) $> 0.5 \cdot V_{CES}$, higher T_J or increased R_G .
 - Pulse Test, $t \leq 300\mu\text{s}$; Duty Cycle, $d \leq 2\%$.

PRELIMINARY TECHNICAL INFORMATION

The product presented herein is under development. The Technical Specifications offered are derived from data gathered during objective characterizations of preliminary engineering lots; but also may yet contain some information supplied during a pre-production design evaluation. IXYS reserves the right to change limits, test conditions, and dimensions without notice.

TO-247 (IXGH) Outline

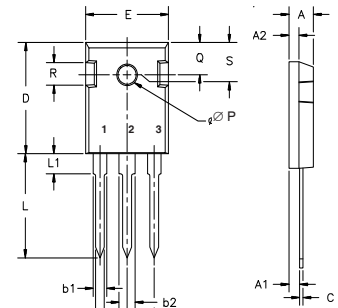

Terminals: 1 - Gate
2 - Drain
3 - Source
Tab - Drain

Dim.	Millimeter		Inches	
	Min.	Max.	Min.	Max.
A	4.7	5.3	.185	.209
A ₁	2.2	2.54	.087	.102
A ₂	2.2	2.6	.059	.098
b	1.0	1.4	.040	.055
b ₁	1.65	2.13	.065	.084
b ₂	2.87	3.12	.113	.123
C	.4	.8	.016	.031
D	20.80	21.46	.819	.845
E	15.75	16.26	.610	.640
e	5.20	5.72	0.205	0.225
L	19.81	20.32	.780	.800
L ₁		4.50		.177
∅P	3.55	3.65	.140	.144
Q	5.89	6.40	0.232	0.252
R	4.32	5.49	.170	.216
S	6.15	BSC	242	BSC

TO-268 (IXGT) Outline

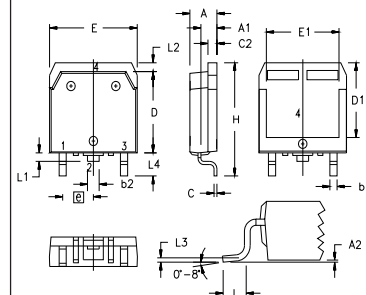

SYM	INCHES		MILLIMETERS	
	MIN	MAX	MIN	MAX
A	.193	.201	4.90	5.10
A1	.106	.114	2.70	2.90
A2	.001	.010	0.02	0.25
b	.045	.057	1.15	1.45
b2	.075	.083	1.90	2.10
C	.016	.026	0.40	0.65
C2	.057	.063	1.45	1.60
D	.543	.551	13.80	14.00
D1	.488	.500	12.40	12.70
E	.624	.632	15.85	16.05
E1	.524	.535	13.30	13.60
e	.215 BSC		5.45 BSC	
H	.736	.752	18.70	19.10
L	.094	.106	2.40	2.70
L1	.047	.055	1.20	1.40
L2	.039	.045	1.00	1.15
L3	.010 BSC		0.25 BSC	
L4	.150	.161	3.80	4.10

IXYS Reserves the Right to Change Limits, Test Conditions and Dimensions.

IXYS MOSFETs and IGBTs are covered by one or more of the following U.S. patents:

4,835,592	4,931,844	5,049,961	5,237,481	6,162,665	6,404,065 B1	6,683,344	6,727,585	7,005,734 B2	7,157,338B2
4,850,072	5,017,508	5,063,307	5,381,025	6,259,123 B1	6,534,343	6,710,405 B2	6,759,692	7,063,975 B2	
4,881,106	5,034,796	5,187,117	5,486,715	6,306,728 B1	6,583,505	6,710,463	6,771,478 B2	7,071,537	

**Fig. 1. Output Characteristics
@ 25°C**

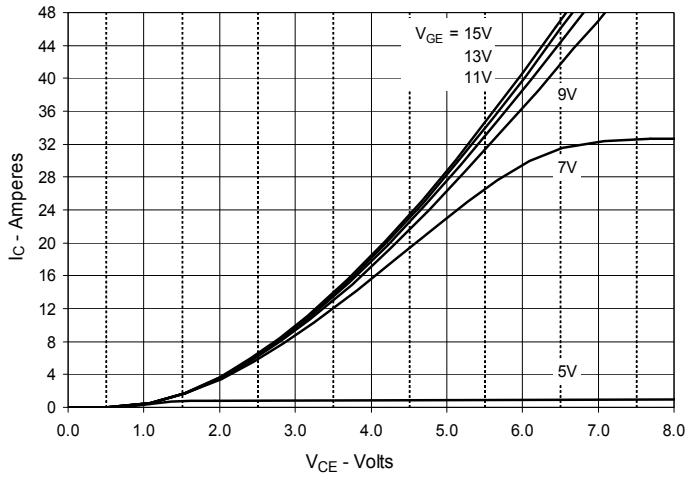

**Fig. 2. Extended Output Characteristics
@ 25°C**

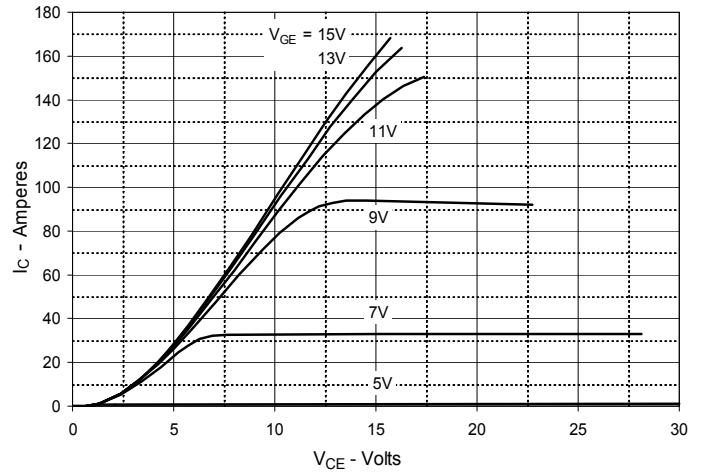

**Fig. 3. Output Characteristics
@ 125°C**

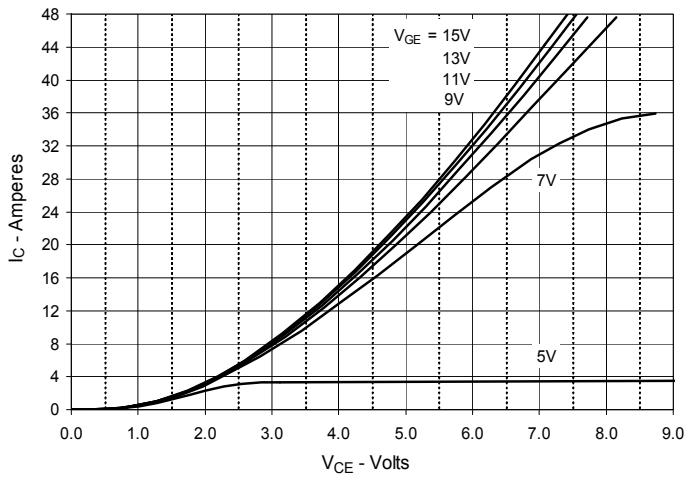

**Fig. 4. Dependence of $V_{CE(sat)}$ on
Junction Temperature**

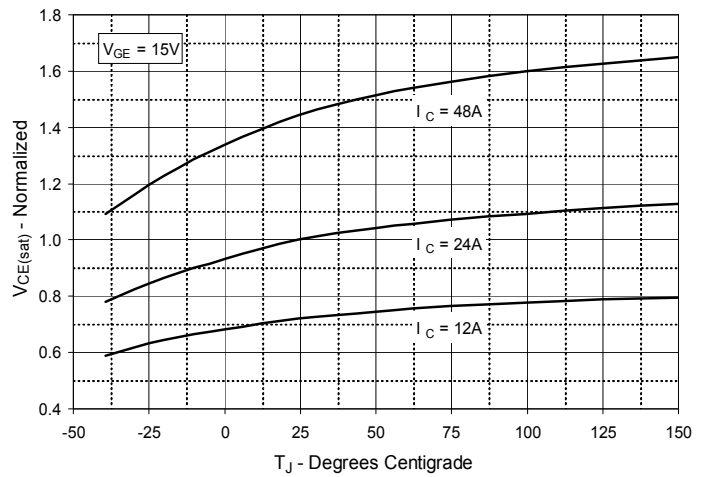

**Fig. 5. Collector-to-Emitter Voltage
vs. Gate-to-Emitter Voltage**

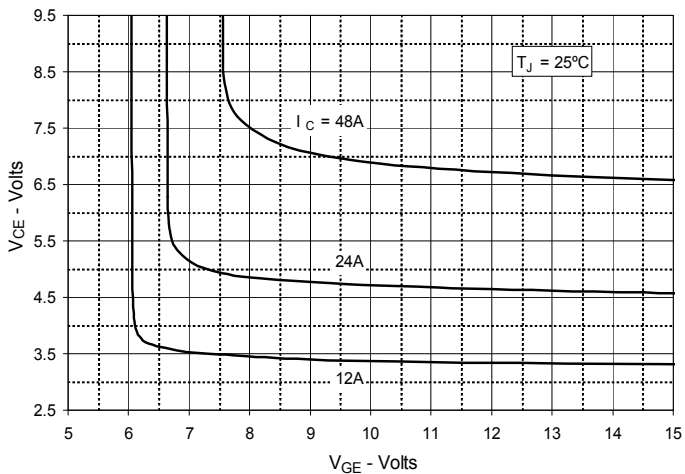

Fig. 6. Input Admittance

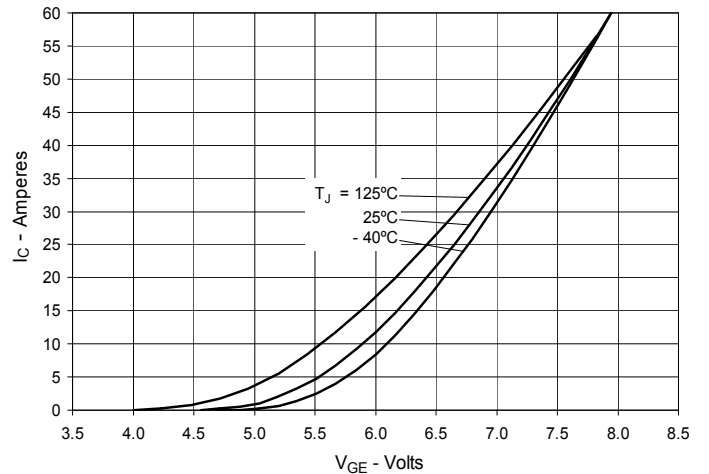

Fig. 7. Transconductance

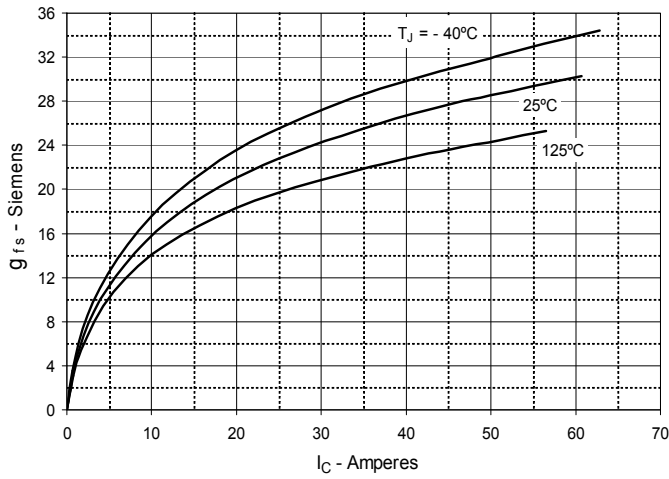

Fig. 8. Gate Charge

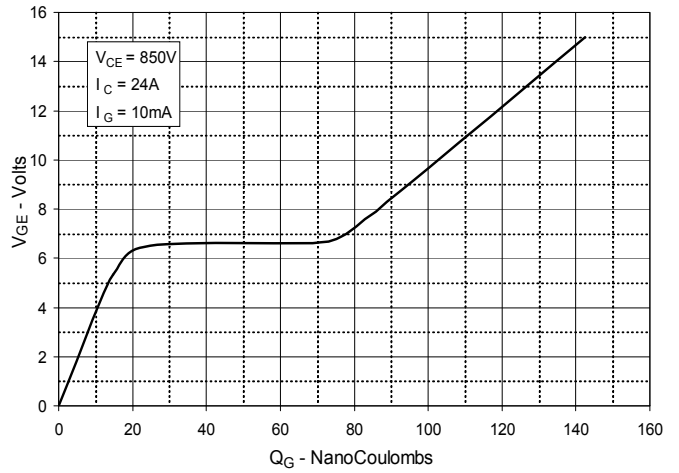

Fig. 9. Capacitance

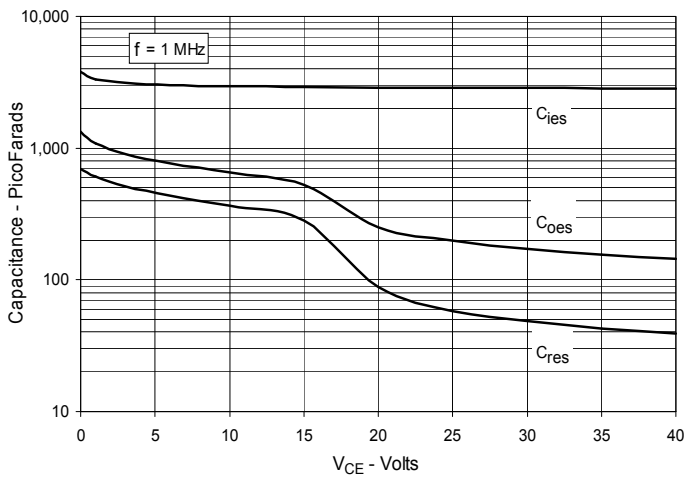

Fig. 10. Reverse-Bias Safe Operating Area

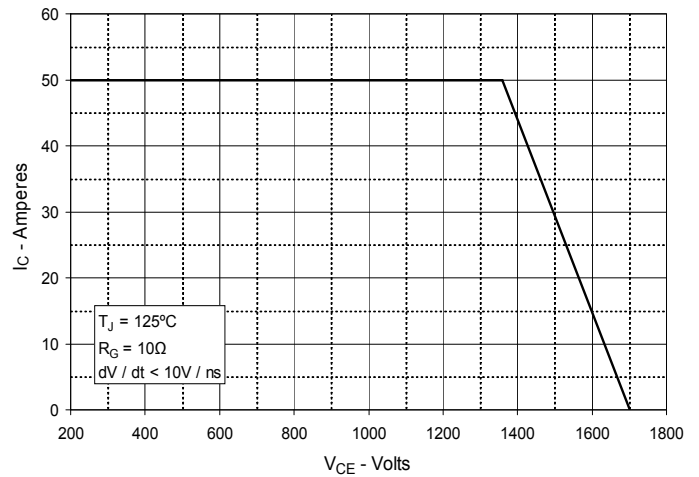
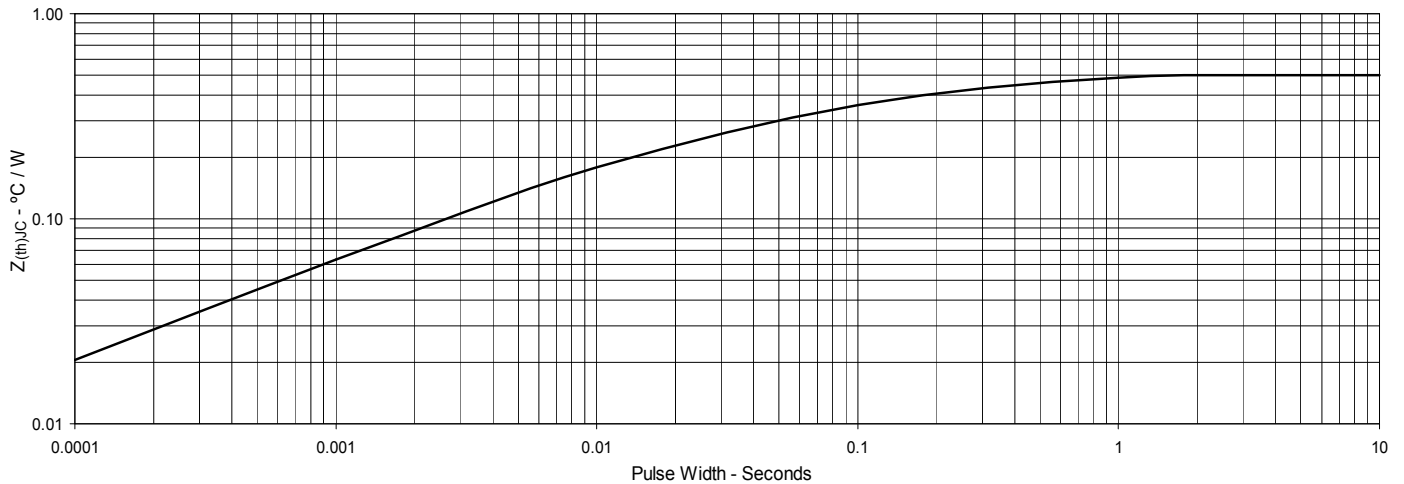

Fig. 11. Maximum Transient Thermal Impedance



IXYS Reserves the Right to Change Limits, Test Conditions and Dimensions.



Disclaimer Notice - Information furnished is believed to be accurate and reliable. However, users should independently evaluate the suitability of and test each product selected for their own applications. Littelfuse products are not designed for, and may not be used in, all applications. Read complete Disclaimer Notice at www.littelfuse.com/disclaimer-electronics.