

SP1026 Series 15pF 30kV Bidirectional Discrete TVS



Description

The SP1026 back-to-back diodes are fabricated in a proprietary silicon avalanche technology. These diodes provide a high ESD (electrostatic discharge) protection level for electronic equipment. The SP1026 TVS can safely absorb repetitive ESD strikes at $\pm 30\text{kV}$ (contact discharge, IEC 61000-4-2) without performance degradation. Additionally, each diode can safely dissipate 5A of 8/20 μs surge current (IEC 61000-4-5) with very low clamping voltages.

Pinout

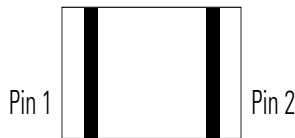

Features

- ESD, IEC 61000-4-2, $\pm 30\text{kV}$ contact, $\pm 30\text{kV}$ air
- EFT, IEC 61000-4-4, 40A (5/50ns)
- Lightning, 5A (8/20 μs as defined in IEC 61000-4-5 2nd edition)
- Low leakage current of 0.5 μA (MAX) at 5V
- Space efficient 0201 footprint
- Halogen free, Lead free and RoHS compliant
- $\mu\text{DFN-2}$ footprint component
- AEC-Q101 qualified

Functional Block Diagram

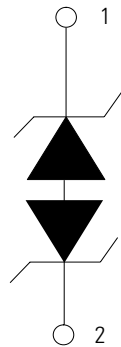

Applications

- Mobile phones
- Smart phones
- Smart watches
- Tablets
- Portable navigation devices
- Portable medical devices

Application Example

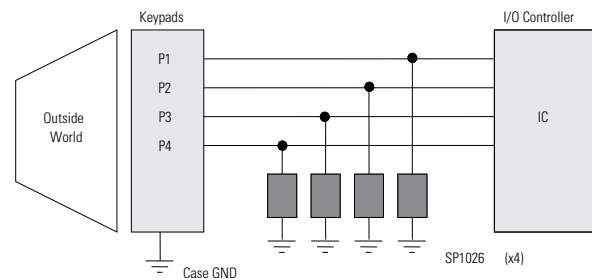

Life Support Note:

Not Intended for Use in Life Support or Life Saving Applications

The products shown herein are not designed for use in life sustaining or life saving applications unless otherwise expressly indicated.

Absolute Maximum Ratings

Symbol	Parameter	Value	Units
I_{PP}	Peak Pulse Current ($t_p=8/20\mu s$)	5	A
T_{OP}	Operating Temperature	-40 to 125	°C
T_{STOR}	Storage Temperature	-55 to 150	°C

CAUTION: Stresses above those listed in "Absolute Maximum Ratings" may cause permanent damage to the component. This is a stress only rating and operation of the component at these or any other conditions above those indicated in the operational sections of this specification is not implied.

Electrical Characteristics ($T_{OP}=25^\circ C$)

Parameter	Symbol	Test Conditions	Min	Typ	Max	Units
Reverse Standoff Voltage	V_{RWM}	$I_R = 1\mu A$	-	-	6.0	V
Breakdown Voltage	V_{BR}	$I_R = 1mA$	-	7.8	-	V
Reverse Leakage Current	I_{LEAK}	$V_R = 5V$	-	0.1	0.5	μA
Clamp Voltage ¹	V_C	$I_{PP} = 1A, t_p = 8/20\mu s$	-	12.0	-	V
		$I_{PP} = 2A, t_p = 8/20\mu s$	-	13.4	-	V
Diode Capacitance ²	R_{DYN}	TLP, $t_p = 100ns$, I/O to GND	-	1.4	-	Ω
ESD Withstand Voltage ¹	V_{ESD}	IEC 61000-4-2 (Contact Discharge)	± 30	-	-	kV
		IEC 61000-4-2 (Air Discharge)	± 30	-	-	kV
Diode Capacitance ¹	$C_{I/O-I/O}$	Reverse Bias=0V, $f = 1\text{ MHz}$	-	15	-	pF
		Reverse Bias=2.5V, $f = 1\text{ MHz}$	-	12	-	pF

1 - Parameter is guaranteed by design and/or component characterization.

2 - Transmission Line Pulse(TLP) with 100ns width, 2ns rise time, and average window $t_1=70ns$ to $t_2=90ns$.

Capacitance vs. Reverse Bias

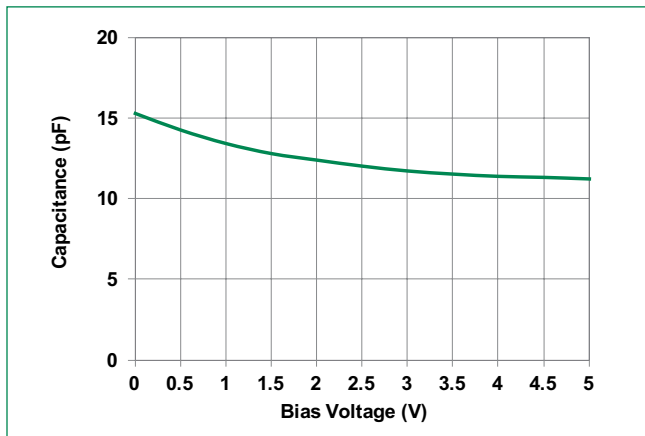

Insertion Loss (S21) I/O to GND

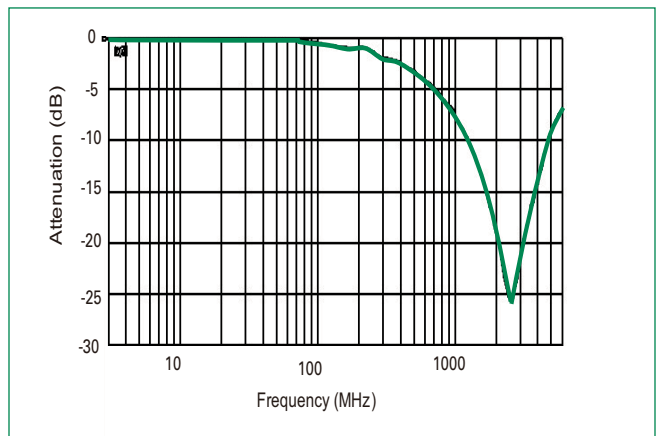

Clamping Voltage vs. I_{PP}

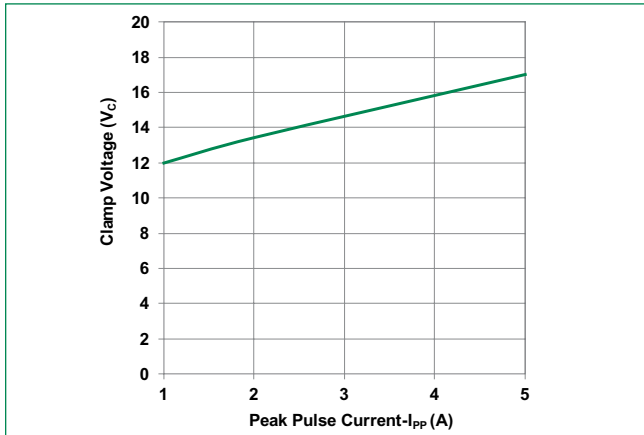

Transmission Line Pulsing(TLP) Plot

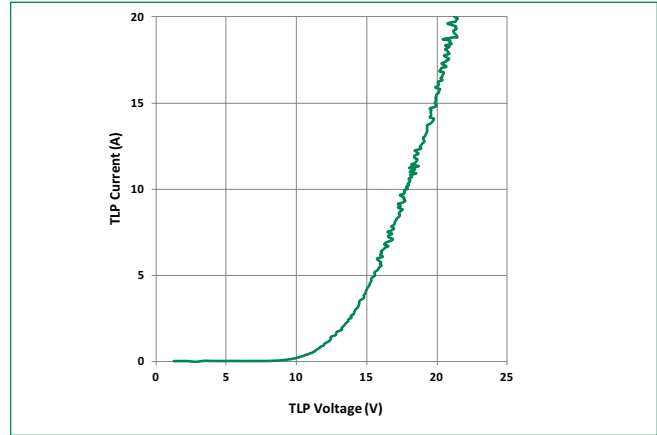

8/20 μ S Pulse Waveform

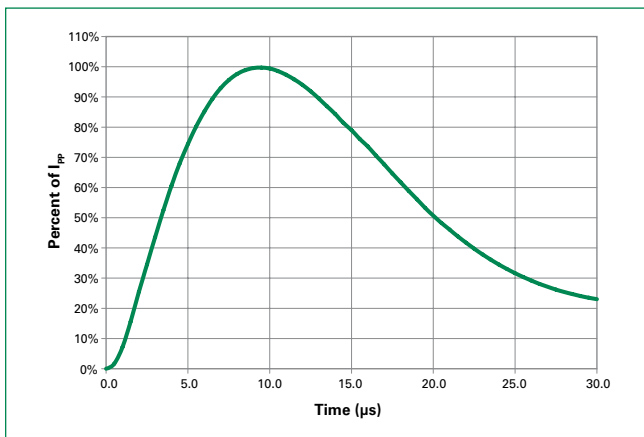

IEC61000-4-2 +8 kV Contact ESD Clamping Voltage

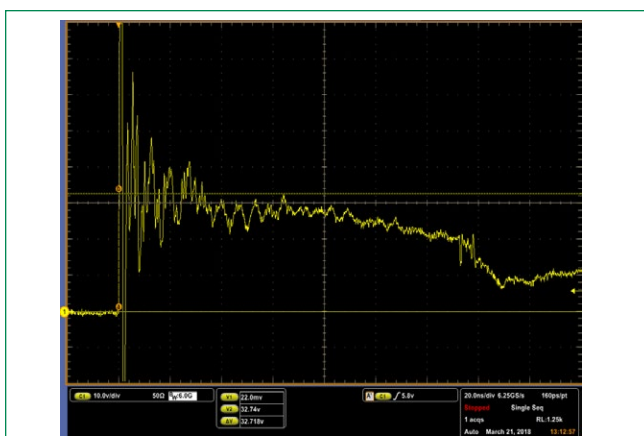

IEC61000-4-2 -8 kV Contact ESD Clamping Voltage

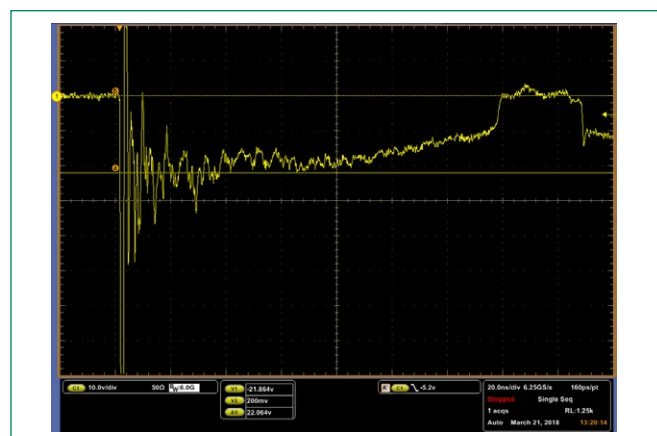

Soldering Parameters

Reflow Condition		Pb – Free assembly
Pre Heat	- Temperature Min ($T_{s(min)}$)	150°C
	- Temperature Max ($T_{s(max)}$)	200°C
	- Time (min to max) (t_s)	60 – 180 secs
Average ramp up rate (Liquidus) Temp (T_L) to peak		3°C/second max
$T_{s(max)}$ to T_L - Ramp-up Rate		3°C/second max
Reflow	- Temperature (T_L) (Liquidus)	217°C
	- Temperature (t_L)	60 – 150 seconds
Peak Temperature (T_p)		260 ^{+0/-5} °C
Time within 5°C of actual peak Temperature (t_p)		20 – 40 seconds
Ramp-down Rate		6°C/second max
Time 25°C to peak Temperature (T_p)		8 minutes Max.

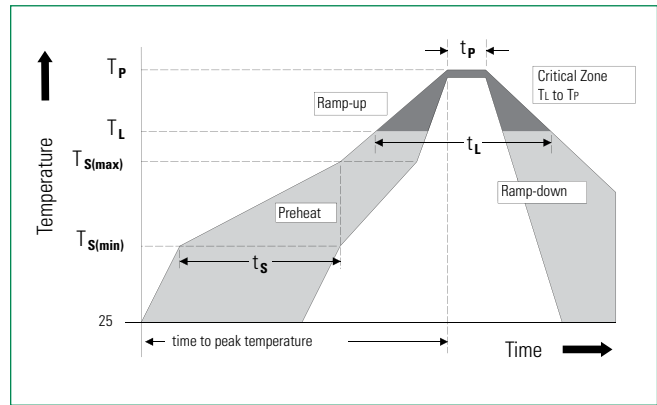

Product Characteristics

Lead Plating	Pre-Plated Frame
Lead Material	Copper Alloy
Substrate material	Silicon
Body Material	Molded Epoxy
Flammability	UL Recognized epoxy meeting flammability rating V-0

Package Dimensions – μ DFN-2 (0201)

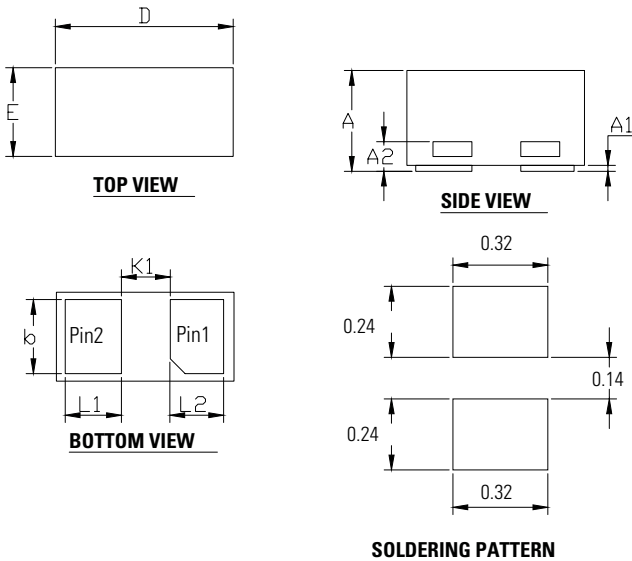

Package	μ DFN-2 (0201)			
	JEDEC MO-236			
	Millimeters		Inches	
Symbol	Min	Max	Min	Max
A	0.23	0.33	0.009	0.013
A1	0.00	0.05	0.000	0.002
A2	0.10 REF		0.004 REF	
b	0.18	0.30	0.007	0.012
D	0.55	0.65	0.022	0.026
E	0.25	0.35	0.010	0.014
L1	0.12	0.24	0.005	0.009
L2	0.12	0.23	0.005	0.009
K1	0.165 REF		0.006 REF	

Part Numbering System

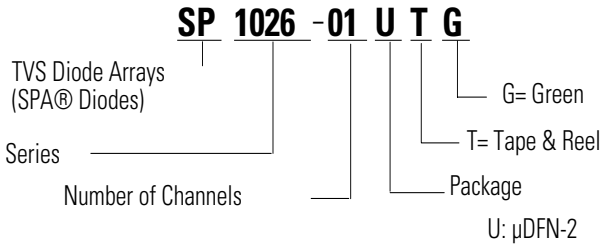

Ordering Information

Part Number	Package	Min. Order Qty.
SP1026-01UTG	μ DFN-2	15000

Part Marking System



Embossed Carrier Tape & Reel Specification – μ DFN-2

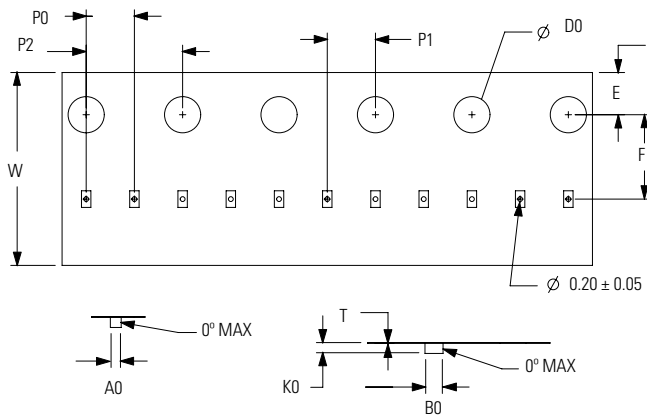

Symbol	Millimetres		Inches	
	Min	Max	Min	Max
A0	0.33	0.40	0.013	0.016
B0	0.63	0.70	0.025	0.028
D0	1.40	1.60	0.055	0.063
E	1.65	1.85	0.065	0.073
F	3.45	3.55	0.136	0.140
K0	0.30	0.39	0.012	0.015
P0	1.90	2.10	0.075	0.083
P1	1.95	2.05	0.077	0.081
P2	3.90	4.10	0.154	0.161
T	0.13	0.25	0.005	0.010
W	7.90	8.30	0.311	0.327

