

# High Voltage IGBT For Capacitor Discharge Applications

## IXGF25N250

$$V_{CES} = 2500V$$

$$I_{C25} = 30A$$

$$V_{CE(sat)} \leq 2.9V$$

( Electrically Isolated Tab )

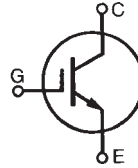

ISOPLUS i4-Pak™

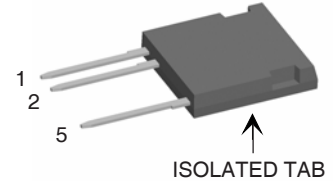

1 = Gate  
2 = Emitter  
5 = Collector

Symbol	Test Conditions	Maximum Ratings	
$V_{CES}$	$T_J = 25^\circ C$ to $150^\circ C$	2500	V
$V_{CGR}$	$T_J = 25^\circ C$ to $150^\circ C$ , $R_{GE} = 1M\Omega$	2500	V
$V_{GES}$	Continuous	$\pm 20$	V
$V_{GEM}$	Transient	$\pm 30$	V
$I_{C25}$	$T_C = 25^\circ C$	30	A
$I_{C110}$	$T_C = 110^\circ C$	15	A
$I_{CM}$	$T_C = 25^\circ C$ , $V_{GE} = 20V$ , 1ms	200	A
<b>SSOA</b> <b>(RBSOA)</b>	$V_{GE} = 20V$ , $T_{VJ} = 125^\circ C$ , $R_G = 20\Omega$ Clamped Inductive Load	$I_{CM} = 240$ $0.5 \cdot V_{CES}$	A
$P_C$	$T_C = 25^\circ C$	114	W
$T_J$		-55 ... +150	$^\circ C$
$T_{JM}$		150	$^\circ C$
$T_{stg}$		-55 ... +150	$^\circ C$
$T_L$	1.6 mm (0.062 in.) from Case for 10s	300	$^\circ C$
$T_{SOLD}$	Plastic Body for 10s	260	$^\circ C$
$F_C$	Mounting Force	20..120/4.5..27	Nm/lbin.
$V_{ISOL}$	50/60Hz, 1 minute	2500	V~
<b>Weight</b>		5	g

### Features

- UL Recognized Package
- Electrically Isolated Tab
- High Peak Current Capability
- Low Saturation Voltage
- MOS Gate Turn-On  
- Drive Simplicity
- Rugged NPT Structure
- Molding Epoxies Meet UL 94 V-0 Flammability Classification

### Applications

- Capacitor Discharge
- Pulser Circuits

### Advantages

- High Power Density
- Easy to Mount

Symbol	Test Conditions ( $T_J = 25^\circ C$ , Unless Otherwise Specified)	Characteristic Values		
		Min.	Typ.	Max.
$BV_{CES}$	$I_C = 250\mu A$ , $V_{GE} = 0V$	2500		V
$V_{GE(th)}$	$I_C = 250\mu A$ , $V_{CE} = V_{GE}$	3.0		5.0 V
$I_{CES}$	$V_{CE} = 0.8 \cdot V_{CES}$ , $V_{GE} = 0V$ , Note 2 $T_J = 125^\circ C$			50 $\mu A$ 1 mA
$I_{GES}$	$V_{CE} = 0V$ , $V_{GE} = \pm 20V$			$\pm 100$ nA
$V_{CE(sat)}$	$I_C = 25A$ , $V_{GE} = 15V$ , Note 1 $I_C = 75A$			2.9 V 5.2 V

Symbol	Test Conditions ( $T_J = 25^\circ\text{C}$ , Unless Otherwise Specified)	Characteristic Values		
		Min.	Typ.	Max.
$g_{fs}$	$I_C = 50\text{A}$ , $V_{CE} = 10\text{V}$ , Note 1	16	26	S
$I_{C(ON)}$	$V_{GE} = 15\text{V}$ , $V_{CE} = 20\text{V}$ , Note 1		240	A
$C_{ies}$	$V_{CE} = 25\text{V}$ , $V_{GE} = 0\text{V}$ , $f = 1\text{MHz}$		2970	pF
$C_{oes}$			98	pF
$C_{res}$			36	pF
$Q_g$	$I_C = 50\text{A}$ , $V_{GE} = 15\text{V}$ , $V_{CE} = 0.5 \cdot V_{CES}$		75	nC
$Q_{ge}$			15	nC
$Q_{gc}$			30	nC
$t_{d(on)}$	<b>Resistive Switching Times</b> $I_C = 50\text{A}$ , $V_{GE} = 15\text{V}$ $V_{CE} = 1250\text{V}$ , $R_G = 5\Omega$		68	ns
$t_r$			233	ns
$t_{d(off)}$			209	ns
$t_f$			200	ns
$R_{thJC}$				1.10 °C/W
$R_{thCS}$		0.15		°C/W
$R_{thJA}$		30		°C/W

- Notes: 1. Pulse Test,  $t < 300\mu\text{s}$ ; Duty Cycle,  $d < 2\%$ .  
 2. Device must be heatsunk for high temperature leakage current measurements to avoid thermal runaway.

### ISOPLUS i4-Pak™ (HV) (IXGF) Outline

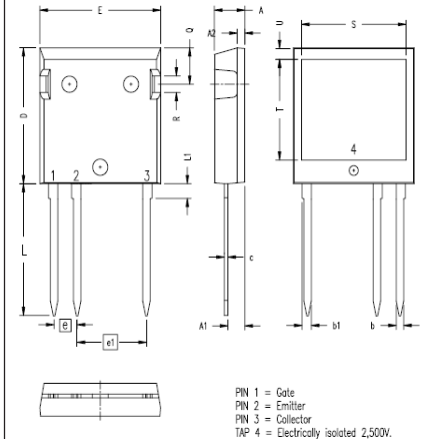

SYM	INCHES		MILLIMETERS	
	MIN	MAX	MIN	MAX
A	.190	.205	4.83	5.21
A1	.102	.118	2.59	3.00
A2	.046	.085	1.17	2.16
b	.045	.055	1.14	1.40
b1	.058	.068	1.47	1.73
C	.020	.029	0.51	0.74
D	.819	.840	20.80	21.34
E	.770	.799	19.56	20.29
e	.150 BSC		3.81 BSC	
e1	.450 BSC		11.43 BSC	
L	.780	.840	19.81	21.34
L1	.083	.102	2.11	2.59
Q	.210	.244	5.33	6.20
R	.100	.180	2.54	4.57
S	.660	.690	16.76	17.53
T	.590	.620	14.99	15.75
U	.065	.080	1.65	2.03

IXYS Reserves the Right to Change Limits, Test Conditions, and Dimensions.

IXYS MOSFETs and IGBTs are covered by one or more of the following U.S. patents:	4,835,592	4,931,844	5,049,961	5,237,481	6,162,665	6,404,065 B1	6,683,344	6,727,585	7,005,734 B2	7,157,338B2
	4,850,072	5,017,508	5,063,307	5,381,025	6,259,123 B1	6,534,343	6,710,405 B2	6,759,692	7,063,975 B2	
	4,881,106	5,034,796	5,187,117	5,486,715	6,306,728 B1	6,583,505	6,710,463	6,771,478 B2	7,071,537	

**Fig. 1. Output Characteristics @ 25°C**

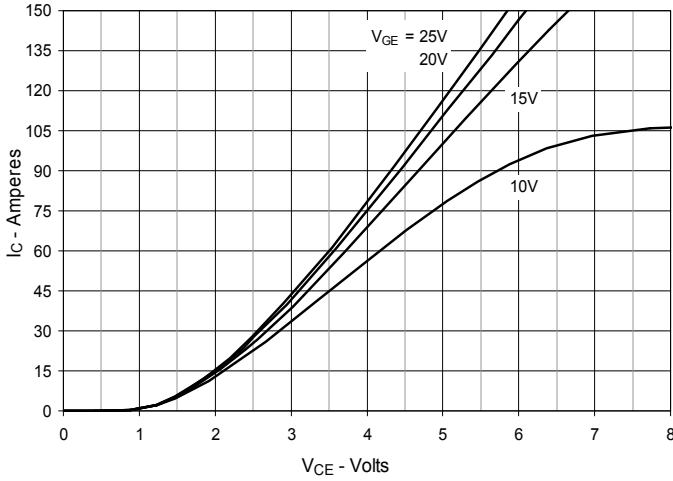

**Fig. 2. Extended Output Characteristics @ 25°C**

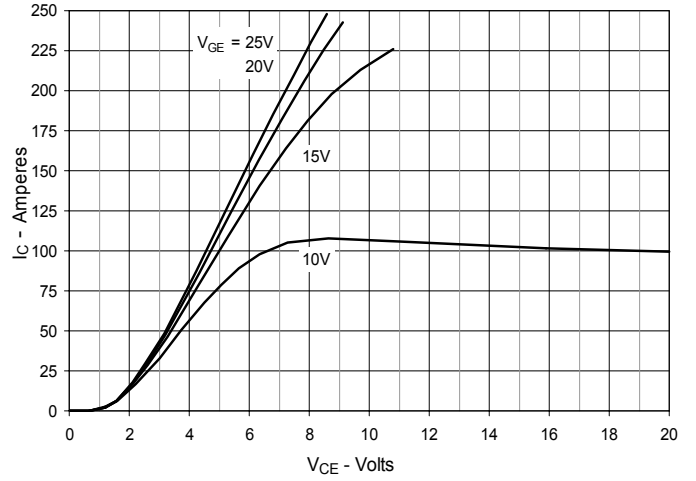

**Fig. 3. Output Characteristics @ 125°C**

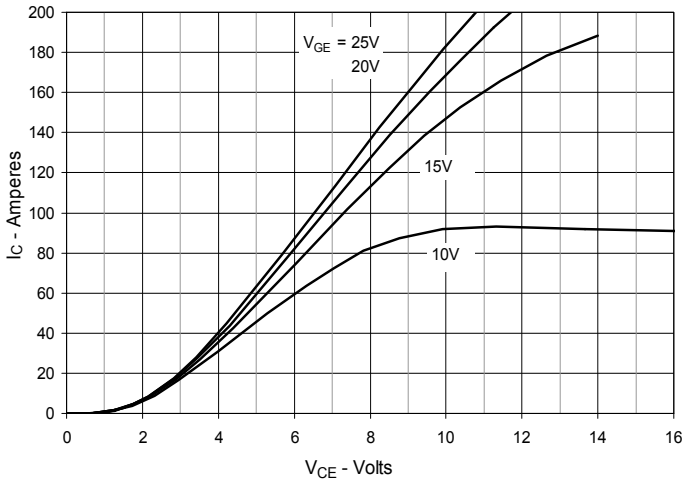

**Fig. 4. Dependence of  $V_{CE(sat)}$  on Junction Temperature**

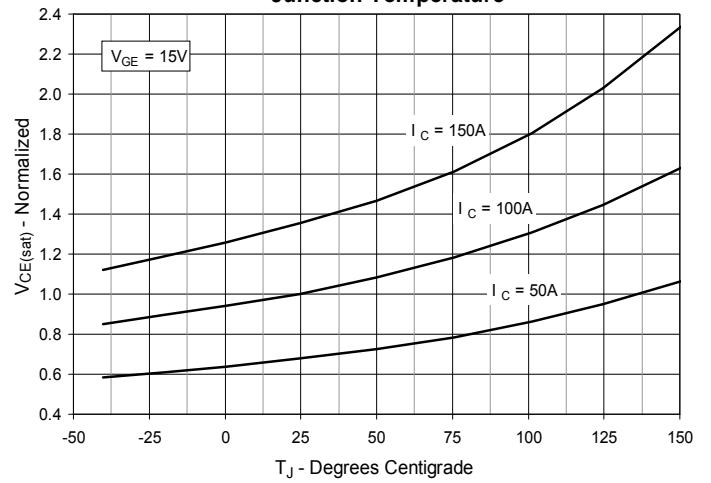

**Fig. 5. Collector-to-Emitter Voltage vs. Gate-to-Emitter Voltage**

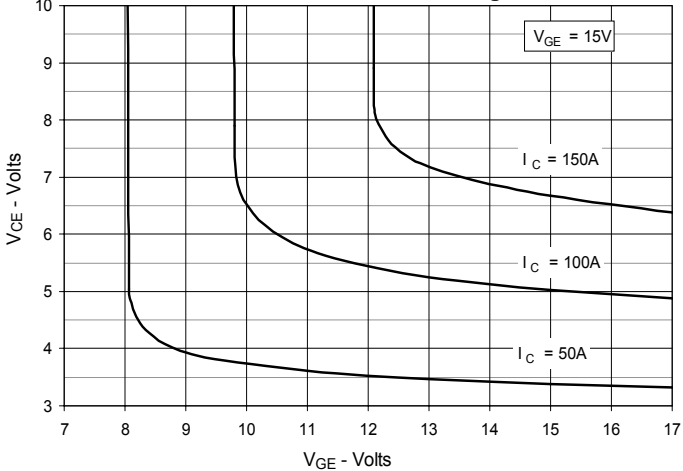

**Fig. 6. Input Admittance**

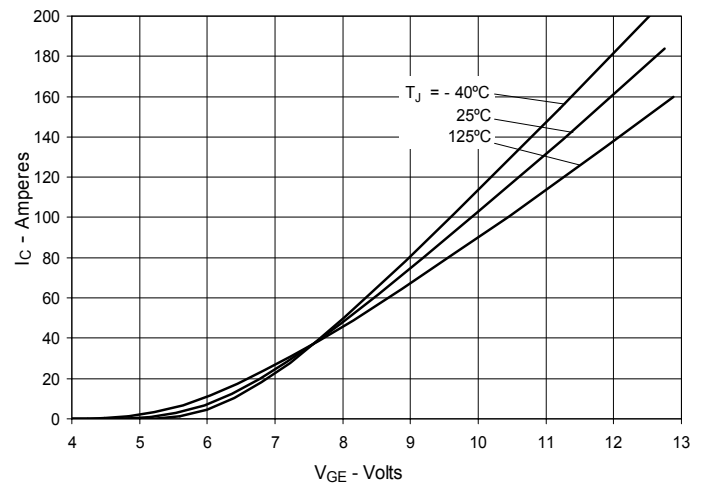

**Fig. 7. Transconductance**

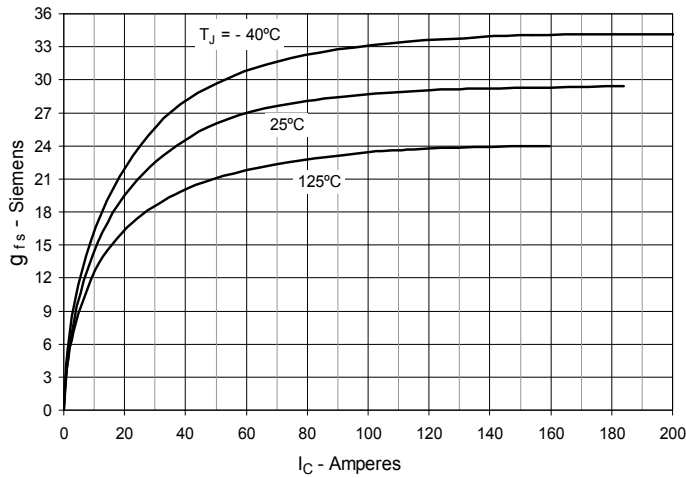

**Fig. 8. Gate Charge**

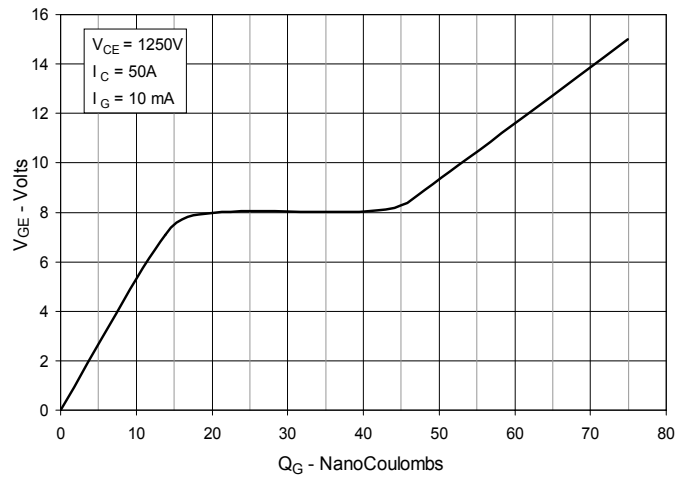

**Fig. 9. Reverse-Bias Safe Operating Area**

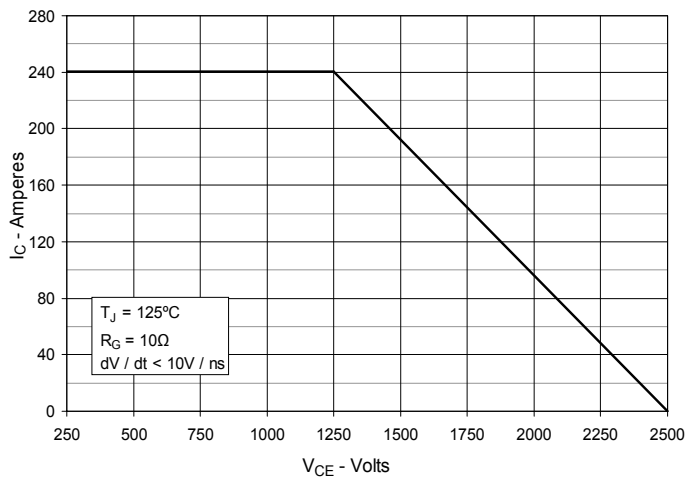

**Fig. 10. Capacitance**

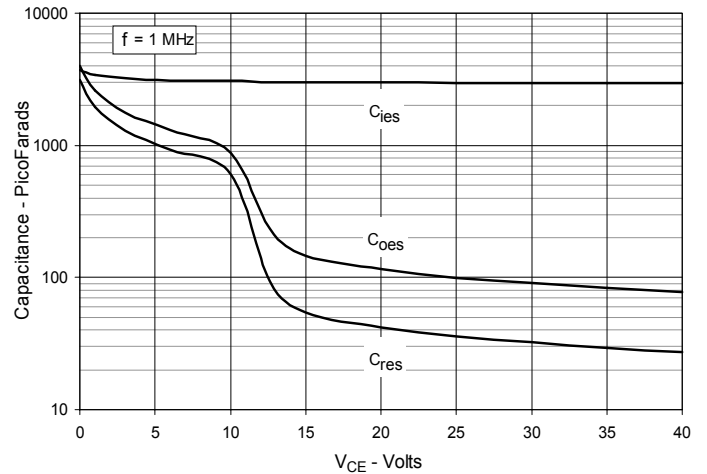

**Fig. 11. Maximum Transient Thermal Impedance**

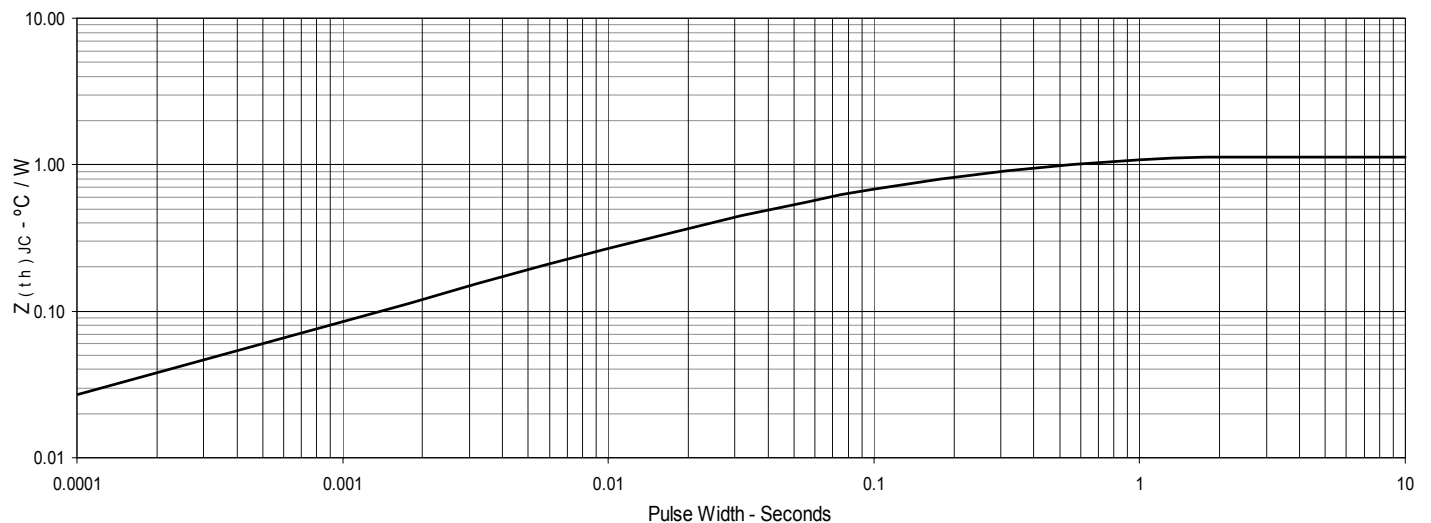

**Fig. 12. Resistive Turn-on Rise Time vs. Junction Temperature**

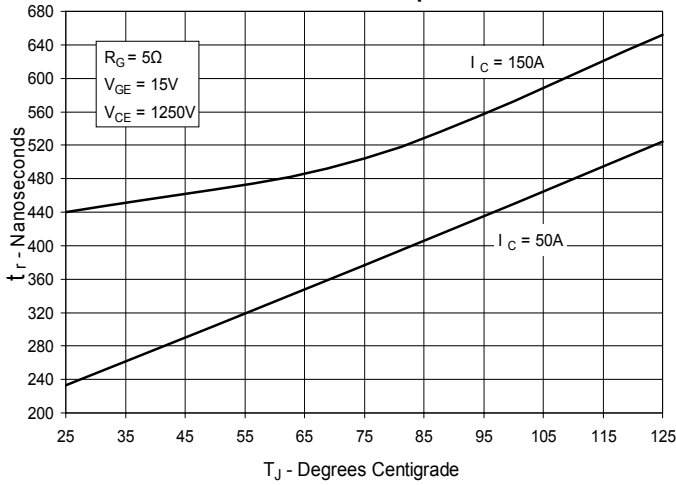

**Fig. 13. Resistive Turn-on Rise Time vs. Collector Current**

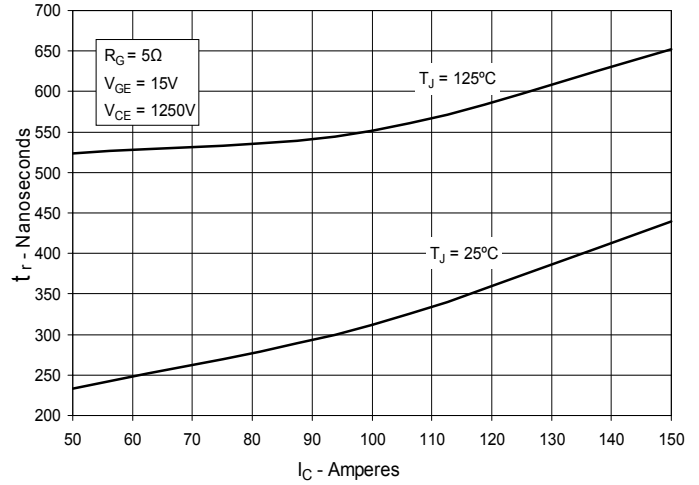

**Fig. 14. Resistive Turn-on Switching Times vs. Gate Resistance**

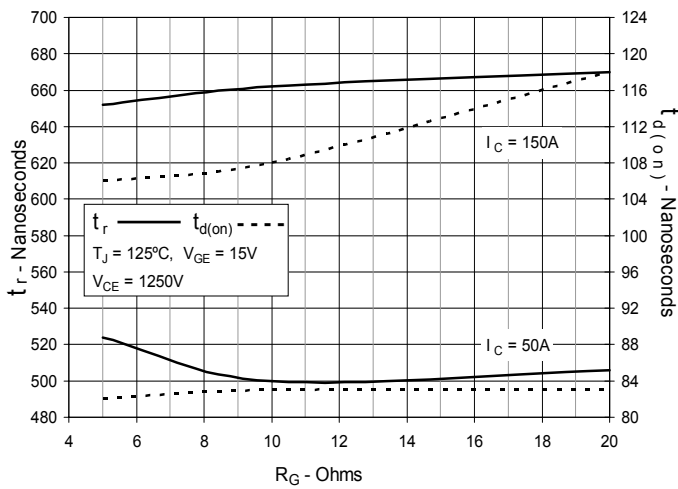

**Fig. 15. Resistive Turn-off Switching Times vs. Junction Temperature**

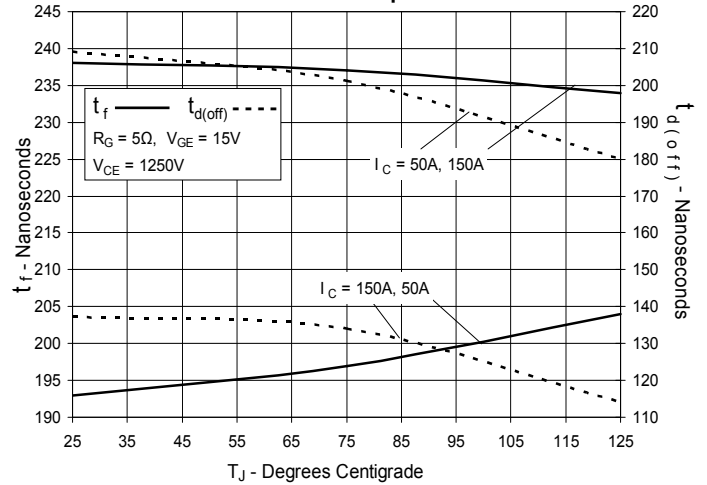

**Fig. 16. Resistive Turn-off Switching Times vs. Collector Current**

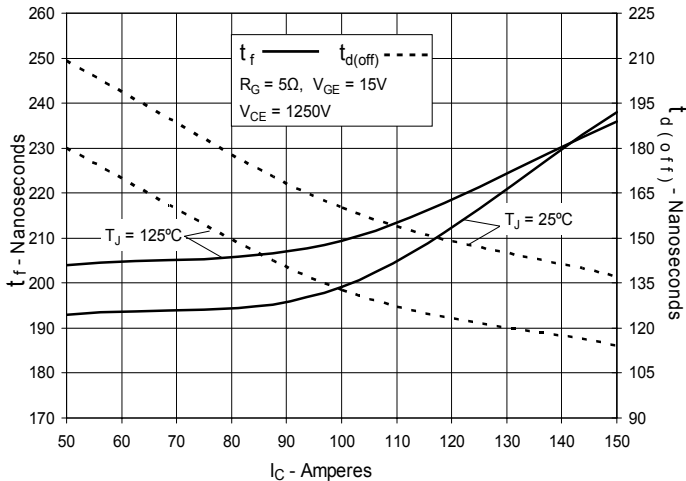

**Fig. 17. Resistive Turn-off Switching Times vs. Gate Resistance**

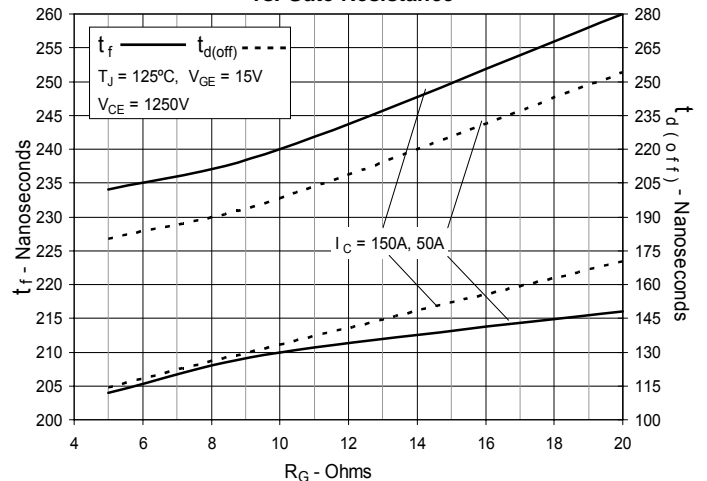



---

Disclaimer Notice - Information furnished is believed to be accurate and reliable. However, users should independently evaluate the suitability of and test each product selected for their own applications. Littelfuse products are not designed for, and may not be used in, all applications. Read complete Disclaimer Notice at [www.littelfuse.com/disclaimer-electronics](http://www.littelfuse.com/disclaimer-electronics).