

Pxxx0SxL

SIDACtor® Series DO-214AA



Agency Approvals

Agency	Agency File Number
	E133083

Schematic Symbol

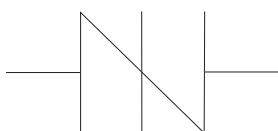

Description

Pxxx0SxL Series DO-214AA are designed to protect baseband equipment such as modems, line cards, CPE and DSL equipments from damaging overvoltage transients.

The series provide a robust peak surge current capability which enables equipments to comply with global regulatory standards.

Features and Benefits

- Low voltage overshoot
- Low on-state voltage
- Does not degrade in capability after multiple surge events within limit.
- Low capacitance
- Fails short circuit when surged in excess of ratings
- Pb-free E3 means 2nd level interconnect is Pb-free and the terminal finish material is tin(Sn) (IPC/JEDEC J-STD-609A.01)
- UL Recognized to UL 497B as an Isolated Loop Circuit Protector

Applicable Global Standards

- TIA-968-A
- TIA-968-B
- ITU K.20/21 Enhanced Level*
- ITU K.20/21 Basic Level
- GR 1089 Inter-building*
- GR 1089 Intra-building
- IEC 61000-4-5 2nd Edition
- YD/T 1082
- YD/T 993
- YD/T 950

*A/B-rated parts require series resistance

Electrical Characteristics

Part Number	Marking	V_{DRM} @ $I_{DRM} = 5\mu A$	V_S @ 100V/ μs	I_H	I_S	I_T	V_T @ $I_T = 2.2 A$	Capacitance @ 1MHz, 2V bias	
		V min	V max	mA min	mA max	A max	V max	pF min	pF max
P0080SALRP	P-8A	6	25	50	800	2.2	4	20	35
P1200SALRP	P12A	100	130	120	800	2.2	4	15	40
P2000SALRP	P20A	180	220	120	800	2.2	4	15	35
P0220SALRP	P22A	15	32	50	800	2.2	4	20	40
P2500SALRP	P25A	230	290	120	800	2.2	4	15	35
P0300SALRP	P03A	25	40	50	800	2.2	4	15	40
P0640SALRP	P06A	58	77	150	800	2.2	4	15	40
P0720SALRP	P07A	65	88	150	800	2.2	4	15	40
P0900SALRP	P09A	75	98	150	800	2.2	4	15	40
P1100SALRP	P11A	90	130	150	800	2.2	4	15	40
P1300SALRP	P13A	120	160	150	800	2.2	4	15	40
P1500SALRP	P15A	140	180	150	800	2.2	4	15	40
P1800SALRP	P18A	170	220	150	800	2.2	4	15	35
P2100SALRP	P21A	180	240	150	800	2.2	4	15	35
P2300SALRP	P23A	190	260	150	800	2.2	4	15	35
P2600SALRP	P26A	220	300	150	800	2.2	4	15	35
P3100SALRP	P31A	275	350	150	800	2.2	4	15	35
P3500SALRP	P35A	320	400	150	800	2.2	4	15	35

Pxxx0SxL

SIDACtor® Series DO-214AA

Electrical Parameters (continued)

Part Number	Marking	V_{DRM} @ $I_{DRM}=5\mu A$	V_S @ 100V/ μs	I_H	I_S	I_T	V_T @ $I_T=2.2$ Amps	Capacitance @ 1MHz, 2V bias	
		V min	V max	mA min	mA max	A max	V max	pF min	pF max
P0080SBLRP	P-8B	6	25	50	800	2.2	4	20	50
P0220SBLRP	P22B	15	32	50	800	2.2	4	20	50
P0300SBLRP	P03B	25	40	50	800	2.2	4	15	50
P0640SBLRP	P06B	58	77	150	800	2.2	4	20	50
P0720SBLRP	P07B	65	88	150	800	2.2	4	20	50
P0900SBLRP	P09B	75	98	150	800	2.2	4	20	50
P1100SBLRP	P11B	90	130	150	800	2.2	4	20	50
P1200SBLRP	P12B	100	130	120	800	2.2	4	20	50
P1300SBLRP	P13B	120	160	150	800	2.2	4	20	50
P1500SBLRP	P15B	140	180	150	800	2.2	4	20	50
P1800SBLRP	P18B	170	220	150	800	2.2	4	20	50
P2000SBLRP	P20B	180	220	120	800	2.2	4	20	50
P2100SBLRP	P21B	180	240	150	800	2.2	4	20	35
P2300SBLRP	P23B	190	260	150	800	2.2	4	20	50
P2500SBLRP	P25B	230	290	120	800	2.2	4	20	50
P2600SBLRP	P26B	220	300	150	800	2.2	4	20	35
P3100SBLRP	P31B	275	350	150	800	2.2	4	20	35
P3500SBLRP	P35B	320	400	150	800	2.2	4	20	35
P4500SBLRP	P45B	400	530	150	800	2.2	4	20	50
P0080SCLRP	P-8C	6	25	50	800	2.2	4	25	70
P0220SCLRP	P22C	15	32	50	800	2.2	4	25	70
P0300SCLRP	P03C	25	40	50	800	2.2	4	20	50
P0640SCLRP	P06C	58	77	150	800	2.2	4	45	100
P0720SCLRP	P07C	65	88	150	800	2.2	4	45	100
P0900SCLRP	P09C	75	98	150	800	2.2	4	45	100
P1100SCLRP	P11C	90	130	150	800	2.2	4	45	90
P1200SCLRP	P12C	100	130	120	800	2.2	4	20	35
P1300SCLRP	P13C	120	160	150	800	2.2	4	40	85
P1500SCLRP	P15C	140	180	150	800	2.2	4	25	70
P1800SCLRP	P18C	170	220	150	800	2.2	4	25	70
P2000SCLRP	P20C	180	220	120	800	2.2	4	25	35
P2100SCLRP	P21C	180	240	150	800	2.2	4	25	70
P2300SCLRP	P23C	190	260	150	800	2.2	4	25	70
P2500SCLRP	P25C	230	290	120	800	2.2	4	30	70
P2600SCLRP	P26C	220	300	150	800	2.2	4	30	70
P3100SCLRP	P31C	275	350	150	800	2.2	4	30	70
P3500SCLRP	P35C	320	400	150	800	2.2	4	25	65
P4500SCLRP	P45C	400	530	150	800	2.2	4	25	65

Notes:

- Absolute maximum ratings measured at $T_A=25^\circ C$ (unless otherwise noted).
- Components are bi-directional.

Surge Ratings

Series	I_{PP}									I_{TSM} 50/60 Hz	di/dt
	0.2/310 ¹ 0.5/700 ²	2/10 ¹ 2/10 ²	8/20 ¹ 1.2/50 ²	10/160 ¹ 10/160 ²	10/560 ¹ 10/560 ²	5/320 ¹ 9/720 ²	10/360 ¹ 10/360 ²	10/1000 ¹ 10/1000 ²	5/310 ¹ 10/700 ²		
	A min	A min	A min	A min	A min	A min	A min	A min	A min		
A	20	150	150	90	50	75	75	45	75	25	500
B	25	250	250	150	100	100	125	80	100	30	500
C	50	500	400	200	150	200	175	100	200	35	500

Notes:

1. Current waveform in μs
 2. Voltage waveform in μs
- Peak pulse current rating (I_{PP}) is repetitive and guaranteed for the life of the product.

- I_{PP} ratings applicable over temperature range of $-40^\circ C$ to $+85^\circ C$
- The component must initially be in thermal equilibrium with $-40^\circ C \leq T_J \leq +150^\circ C$

Pxxx0SxL

SIDACtor® Series DO-214AA

Thermal Considerations

Package	Symbol	Parameter	Value	Unit
	T_J	Operating Junction Temperature Range	-40 to +150	°C
	T_S	Storage Temperature Range	-65 to +150	°C
	$R_{\theta JA}$	Thermal Resistance: Junction to Ambient	90	°C/W

V-I Characteristics

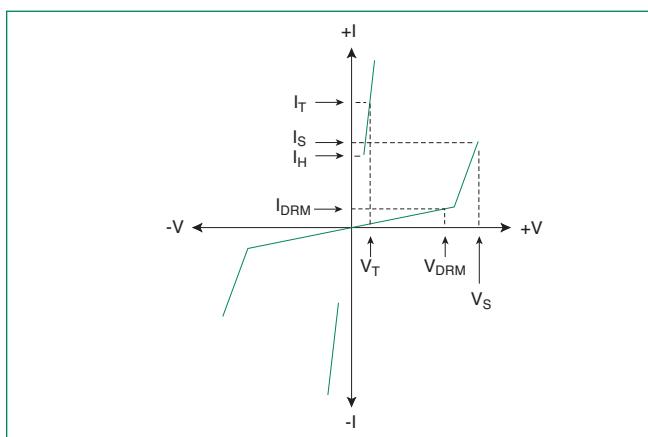

tr x td Pulse Waveform

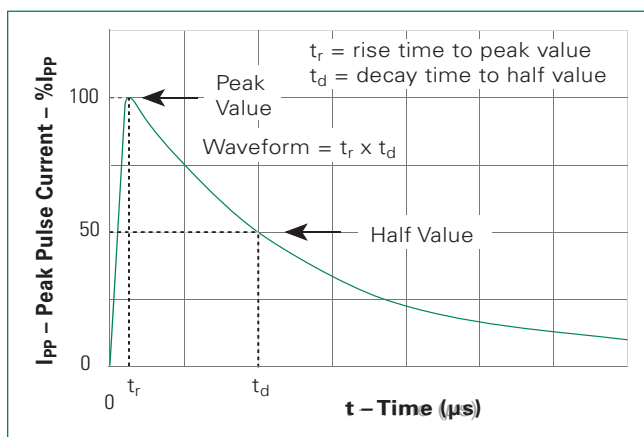

Normalized VS Change vs. Junction Temperature

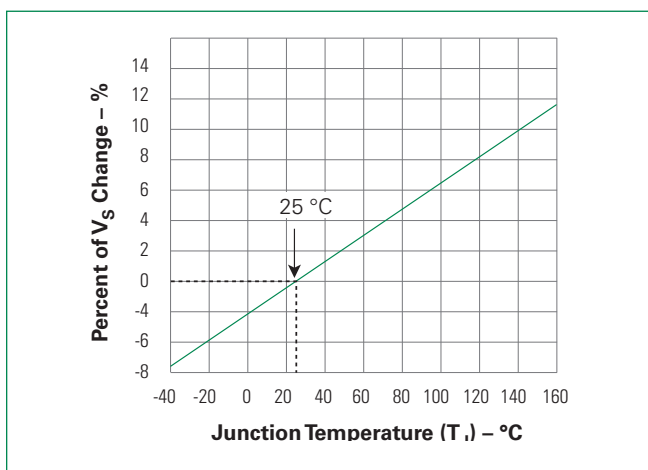

Normalized DC Holding Current vs. Case Temperature

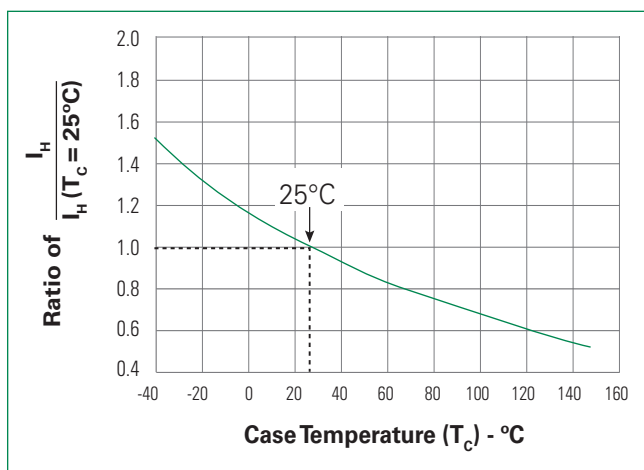

Pxxx0SxL

SIDACtor® Series DO-214AA

Soldering Parameters

Reflow Condition		Pb-Free assembly
Pre Heat	- Temperature Min ($T_{s(min)}$)	+150°C
	- Temperature Max ($T_{s(max)}$)	+200°C
	- Time (Min to Max) (t_p)	60-120 secs.
Average ramp up rate (Liquidus Temp (T_L) to peak)		3°C/sec. Max.
$T_{s(max)}$ to T_L - Ramp-up Rate		3°C/sec. Max.
Reflow	- Temperature (T_L) (Liquidus)	+217°C
	- Temperature (t_L)	60-150 secs.
Peak Temp (T_p)		+260(+0/-5)°C
Time within 5°C of actual Peak Temp (t_p)		30 secs. Max.
Ramp-down Rate		6°C/sec. Max.
Time 25°C to Peak Temp (T_p)		8 min. Max.
Do not exceed		+260°C

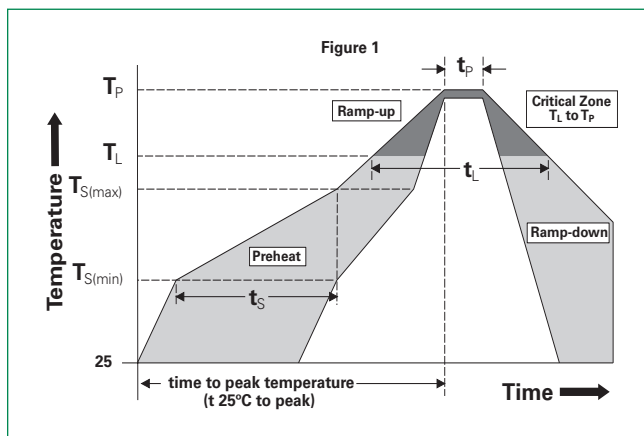

Physical Specifications

Lead Material	Copper Alloy
Terminal Finish	100% Matte-Tin Plated
Body Material	UL Recognized Epoxy meeting flammability classification UL94-V0

Environmental Specifications

High Temp Voltage Blocking	80% Rated V_{DRM} (V_{AC} Peak) +125°C or +150°C, 504 or 1008 hrs. MIL-STD-750 (Method 1040) JEDEC, JESD22-A-101
Temp Cycling	-65°C to +150°C, 15 min. dwell, 10 up to 100 cycles. MIL-STD-750 (Method 1051) EIA/JEDEC, JESD22-A104
Biased Temp & Humidity	52 V_{DC} (+85°C) 85%RH, 504 up to 1008 hrs. EIA/JEDEC, JESD22-A-101
High Temp Storage	+150°C 1008 hrs. MIL-STD-750 (Method 1031) JEDEC, JESD22-A-101
Low Temp Storage	-65°C, 1008 hrs.
Thermal Shock	0°C to +100°C, 5 min. dwell, 10 sec. transfer, 10 cycles. MIL-STD-750 (Method 1056) JEDEC, JESD22-A-106
Autoclave (Pressure Cooker Test)	+121°C, 100%RH, 2atm, 24 up to 168 hrs. EIA/JEDEC, JESD22-A-102
Resistance to Solder Heat	+260°C, 30 secs. MIL-STD-750 (Method 2031)
Moisture Sensitivity Level	85%RH, +85°C, 168 hrs., 3 reflow cycles (+260°C Peak). JEDEC-J-STD-020, Level 1

Part Numbering

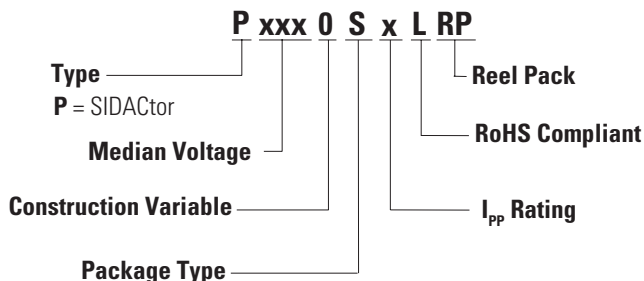

Part Marking

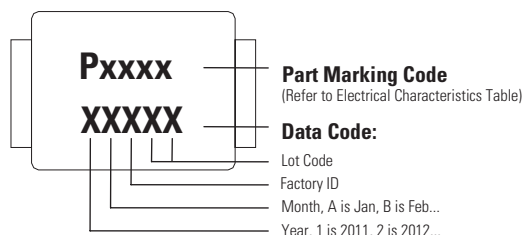

Pxxx0SxL

SIDACtor® Series DO-214AA

Dimensions – DO-214AA

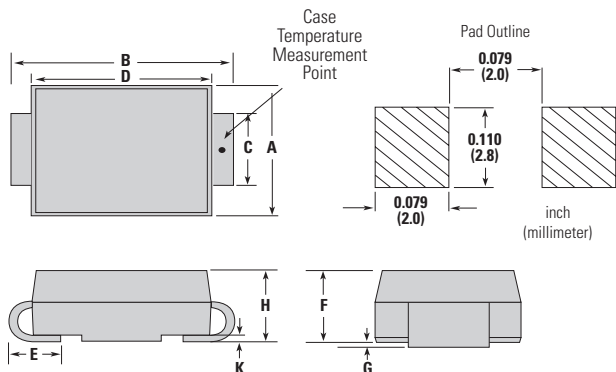

Dimensions	Inches		Millimeters	
	Min	Max	Min	Max
A	0.130	0.156	3.30	3.95
B	0.201	0.220	5.10	5.60
C	0.077	0.087	1.95	2.20
D	0.159	0.181	4.05	4.60
E	0.030	0.063	0.75	1.60
F	0.075	0.096	1.90	2.45
G	0.002	0.008	0.05	0.20
H	0.077	0.104	1.95	2.65
K	0.006	0.016	0.15	0.41

Packing Options

Package Type	Description	Quantity	Added Suffix	Industry Standard
S	DO-214AA Tape & Reel Pack	2500	RP	EIA-481-D

Tape and Reel Specification – DO-214AA

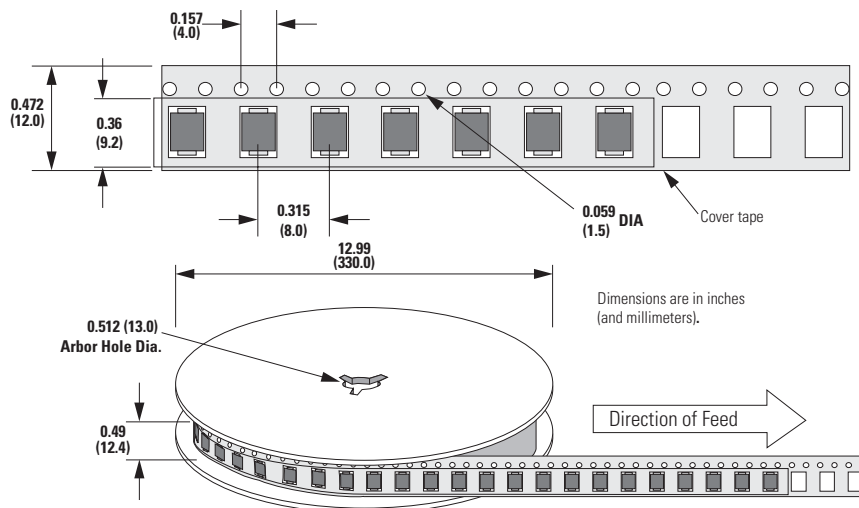

Disclaimer Notice - Information furnished is believed to be accurate and reliable. However, users should independently evaluate the suitability of and test each product selected for their own applications. Littelfuse products are not designed for, and may not be used in, all applications. Read complete Disclaimer Notice at www.littelfuse.com/disclaimer-electronics.