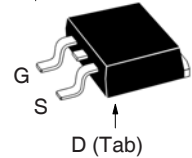
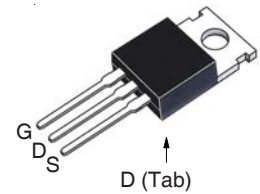

**Trench™ HiperFET™
Power MOSFET**
**IXFA130N10T
IXFP130N10T**
 $V_{DSS} = 100V$
 $I_{D25} = 130A$
 $R_{DS(on)} \leq 9.1m\Omega$

 N-Channel Enhancement Mode
 Avalanche Rated
 Fast Intrinsic Diode

**TO-263
(IXFA)**

**TO-220
(IXFP)**

 G = Gate D = Drain
 S = Source Tab = Drain

Symbol	Test Conditions	Maximum Ratings	
V_{DSS}	$T_J = 25^\circ C$ to $175^\circ C$	100	V
V_{DGR}	$T_J = 25^\circ C$ to $175^\circ C$, $R_{GS} = 1M\Omega$	100	V
V_{GSS}	Continuous	± 20	V
V_{GSM}	Transient	± 30	V
I_{D25}	$T_C = 25^\circ C$	130	A
I_{LRMS}	Lead Current Limit, RMS	120	A
I_{DM}	$T_C = 25^\circ C$, Pulse Width Limited by T_{JM}	350	A
I_A	$T_C = 25^\circ C$	65	A
E_{AS}	$T_C = 25^\circ C$	750	mJ
P_D	$T_C = 25^\circ C$	360	W
T_J		-55 ... +175	$^\circ C$
T_{JM}		175	$^\circ C$
T_{stg}		-55 ... +175	$^\circ C$
T_L	Maximum Lead Temperature for Soldering	300	$^\circ C$
T_{SOLD}	1.6 mm (0.062in.) from Case for 10s	260	$^\circ C$
F_C	Mounting Force (TO-263)	10..65 / 2.2..14.6	N/lb
M_d	Mounting Torque (TO-220)	1.13 / 10	Nm/lb.in
Weight	TO-263	2.5	g
	TO-220	3.0	g

Features

- Ultra-Low On Resistance
- Avalanche Rated
- Low Package Inductance
 - Easy to Drive and to Protect
- $175^\circ C$ Operating Temperature
- Fast Intrinsic Diode

Advantages

- Easy to Mount
- Space Savings
- High Power Density

Applications

- Automotive
 - Motor Drives
 - 42V Power Bus
 - ABS Systems
- DC/DC Converters and Off-line UPS
- Primary Switch for 24V and 48V Systems
- Distributed Power Architectures and VRMs
- Electronic Valve Train Systems
- High Current Switching Applications
- High Voltage Synchronous Rectifier

Symbol	Test Conditions ($T_J = 25^\circ C$ Unless Otherwise Specified)	Characteristic Values		
		Min.	Typ.	Max.
BV_{DSS}	$V_{GS} = 0V$, $I_D = 250\mu A$	100		V
$V_{GS(th)}$	$V_{DS} = V_{GS}$, $I_D = 1mA$	2.5		V
I_{GSS}	$V_{GS} = \pm 20V$, $V_{DS} = 0V$		± 200	nA
I_{DSS}	$V_{DS} = V_{DSS}$, $V_{GS} = 0V$ $T_J = 150^\circ C$		10 500	μA μA
$R_{DS(on)}$	$V_{GS} = 10V$, $I_D = 25A$, Notes 1, 2		9.1	m Ω

Symbol	Test Conditions	Characteristic Values			
		Min.	Typ.	Max.	
$(T_J = 25^\circ\text{C Unless Otherwise Specified})$					
g_{fs}	$V_{DS} = 10\text{V}, I_D = 60\text{A}, \text{Note 1}$	55	93	S	
C_{iss}	$V_{GS} = 0\text{V}, V_{DS} = 25\text{V}, f = 1\text{MHz}$		5080	pF	
C_{oss}					
C_{rss}					
Resistive Switching Times					
$t_{d(on)}$	$V_{GS} = 10\text{V}, V_{DS} = 0.5 \cdot V_{DSS}, I_D = 25\text{A}$		30	ns	
t_r					
$t_{d(off)}$					
t_f					
R_{thJC}	TO-220	0.50		0.42	$^\circ\text{C/W}$
R_{thCH}				$^\circ\text{C/W}$	

Source-Drain Diode

Symbol	Test Conditions	Characteristic Values			
		Min.	Typ.	Max.	
$(T_J = 25^\circ\text{C Unless Otherwise Specified})$					
I_S	$V_{GS} = 0\text{V}$			130	A
I_{SM}	Repetitive, Pulse Width Limited by T_{JM}			350	A
V_{SD}	$I_F = 25\text{A}, V_{GS} = 0\text{V}, \text{Note 1}$			1.0	V
t_{rr}	$I_F = 65\text{A}, -di/dt = 100\text{A}/\mu\text{s}$		67	ns	
I_{RM}					
Q_{rr}					
	$V_R = 0.5 \cdot V_{DSS}, V_{GS} = 0\text{V}$		4.7	A	
			160	nC	

- Notes: 1. Pulse test, $t \leq 300 \mu\text{s}$; duty cycle, $d \leq 2\%$.
 2. On through-hole packages, $R_{DS(on)}$ Kelvin test contact location must be 5 mm or less from the package body.

PRELIMINARY TECHNICAL INFORMATION

The product presented herein is under development. The Technical Specifications offered are derived from data gathered during objective characterizations of preliminary engineering lots; but also may yet contain some information supplied during a pre-production design evaluation. IXYS reserves the right to change limits, test conditions, and dimensions without notice.

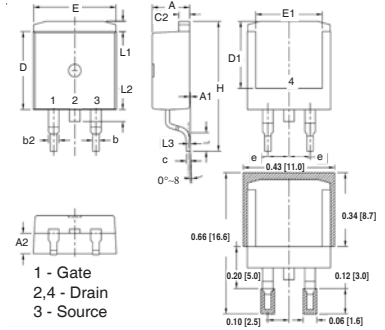
TO-263 Outline

SYM	INCHES		MILLIMETER	
	MIN	MAX	MIN	MAX
A	.170	.185	4.30	4.70
A1	.000	.008	0.00	0.20
A2	.091	.098	2.30	2.50
b	.028	.035	0.70	0.90
b2	.046	.060	1.18	1.52
C	.018	.024	0.45	0.60
C2	.049	.060	1.25	1.52
D	.340	.370	8.63	9.40
D1	.300	.327	7.62	8.30
E	.380	.410	9.65	10.41
E1	.270	.330	6.86	8.38
(e)	.100 BSC		2.54 BSC	
H	.580	.620	14.73	15.75
L	.075	.105	1.91	2.67
L1	.039	.060	1.00	1.52
L2	—	.070	—	1.77
(L3)	.010 BSC		0.254 BSC	

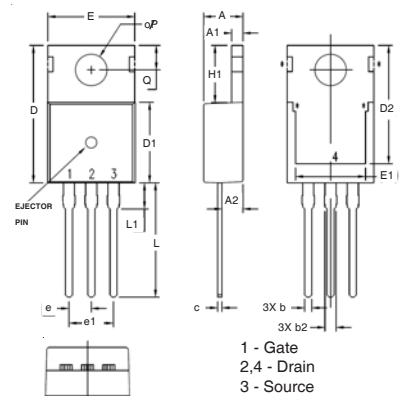
TO-220 Outline

SYM	INCHES		MILLIMETERS	
	MIN	MAX	MIN	MAX
A	.169	.185	4.30	4.70
A1	.047	.055	1.20	1.40
A2	.079	.106	2.00	2.70
b	.024	.039	0.60	1.00
b2	.045	.057	1.15	1.45
c	.014	.026	0.35	0.65
D	.587	.626	14.90	15.90
D1	.335	.370	8.50	9.40
(D2)	.500	.531	12.70	13.50
E	.382	.406	9.70	10.30
(E1)	.283	.323	7.20	8.20
e	.100 BSC		2.54 BSC	
e1	.200 BSC		5.08 BSC	
H1	.244	.268	6.20	6.80
L	.492	.547	12.50	13.90
L1	.110	.154	2.80	3.90
∅P	.134	.150	3.40	3.80
Q	.106	.126	2.70	3.20

IXYS reserves the right to change limits, test conditions, and dimensions.

IXYS MOSFETs and IGBTs are covered by one or more of the following U.S. patents:	4,835,592	4,931,844	5,049,961	5,237,481	6,162,665	6,404,065 B1	6,683,344	6,727,585	7,005,734 B2	7,157,338B2
	4,860,072	5,017,508	5,063,307	5,381,025	6,259,123 B1	6,534,343	6,710,405 B2	6,759,692	7,063,975 B2	
	4,881,106	5,034,796	5,187,117	5,486,715	6,306,728 B1	6,583,505	6,710,463	6,771,478 B2	7,071,537	

Fig. 1. Output Characteristics @ $T_J = 25^\circ\text{C}$

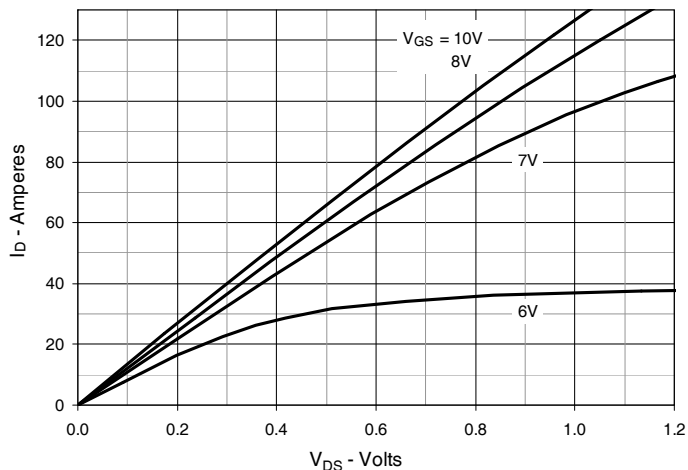

Fig. 2. Extended Output Characteristics @ $T_J = 25^\circ\text{C}$

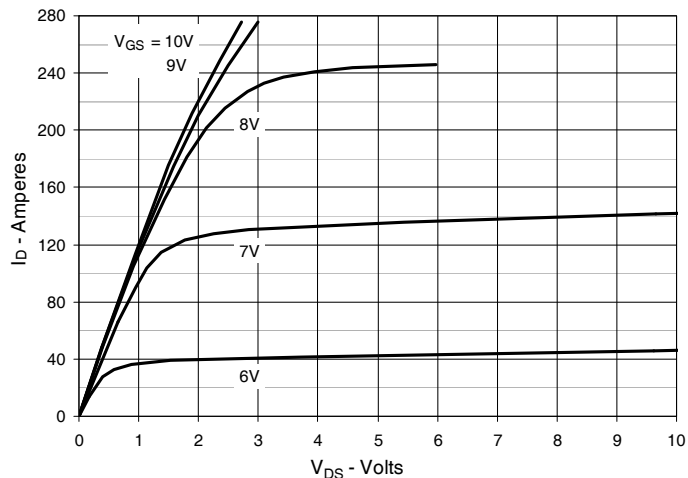

Fig. 3. Output Characteristics @ $T_J = 150^\circ\text{C}$

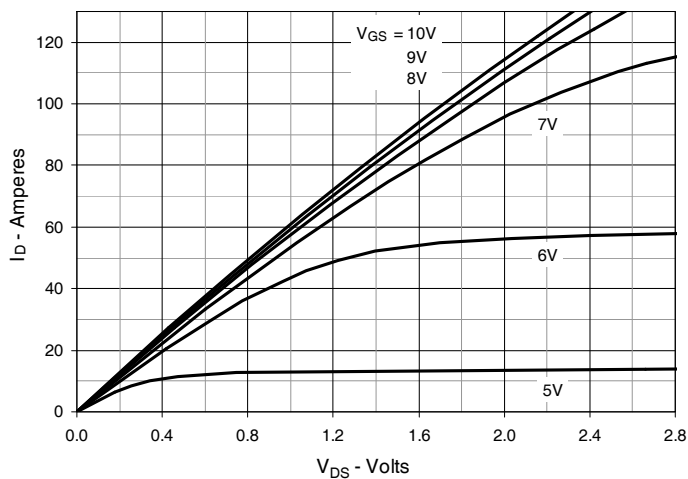

Fig. 4. $R_{DS(on)}$ Normalized to $I_D = 65\text{A}$ Value vs. Junction Temperature

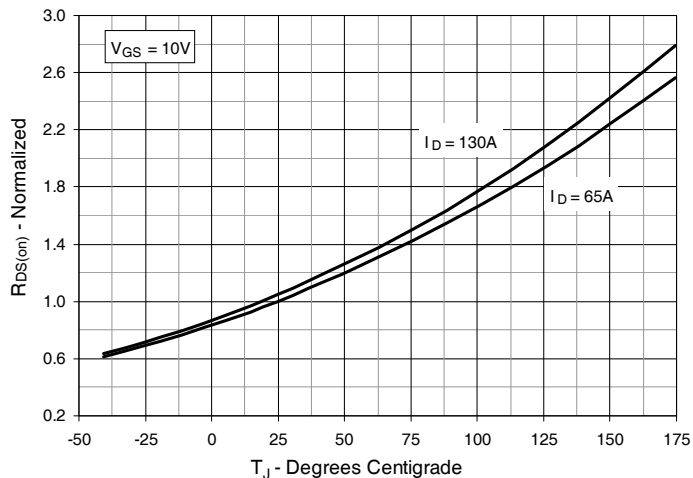

Fig. 5. $R_{DS(on)}$ Normalized to $I_D = 65\text{A}$ Value vs. Drain Current

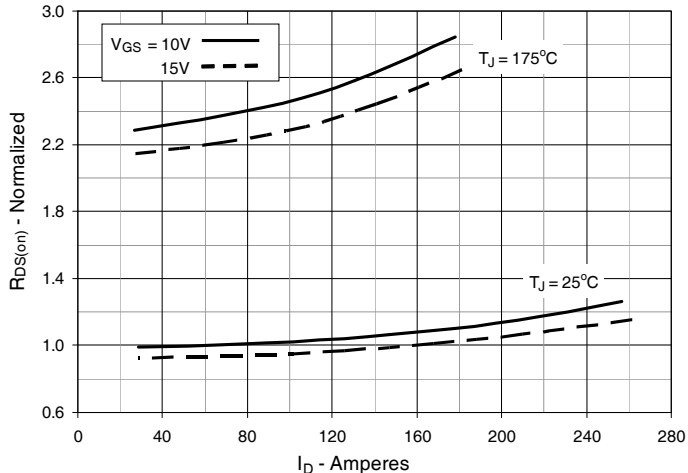

Fig. 6. Drain Current vs. Case Temperature

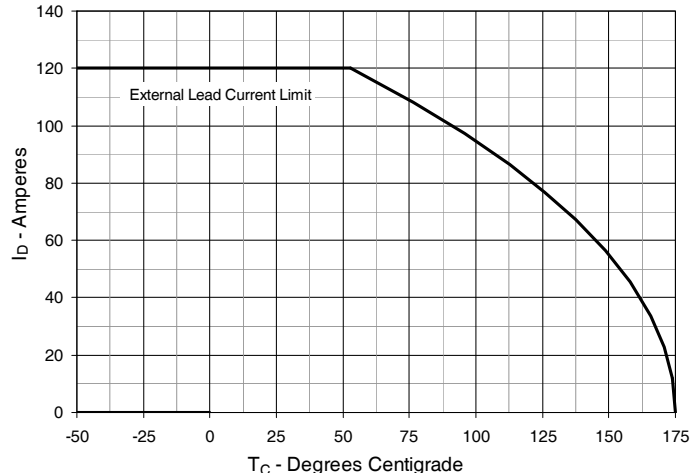

Fig. 7. Input Admittance

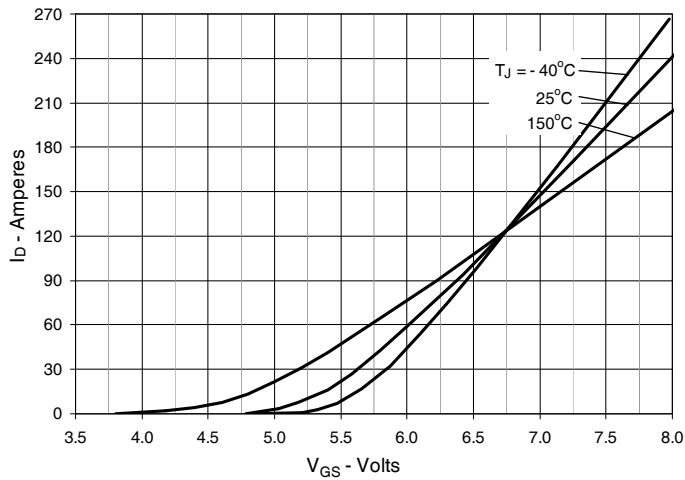

Fig. 8. Transconductance

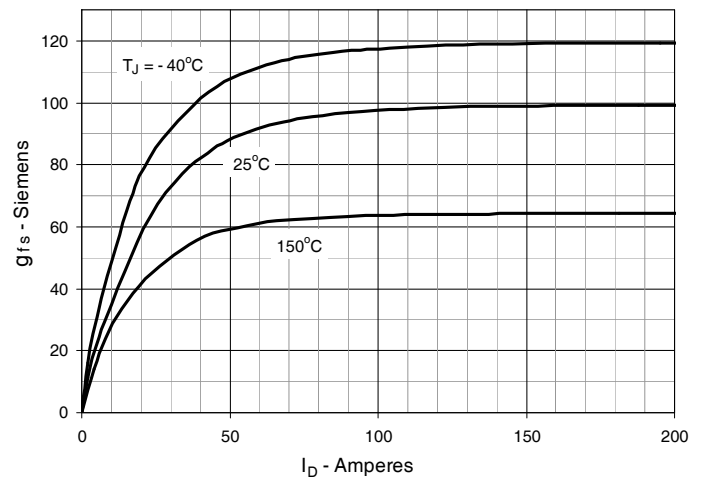

Fig. 9. Forward Voltage Drop of Intrinsic Diode

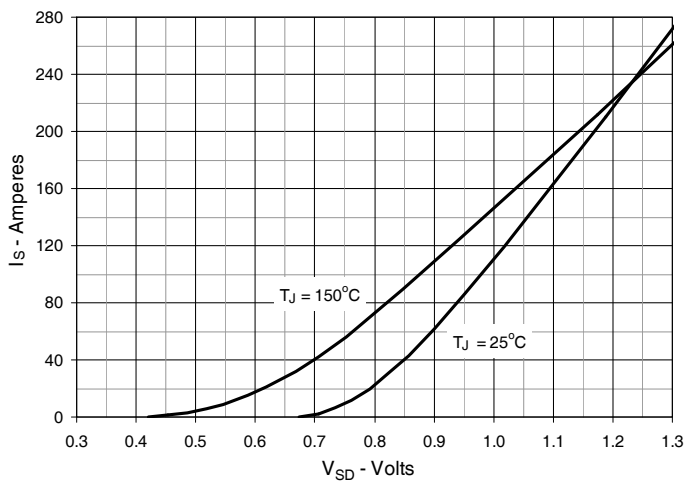

Fig. 10. Gate Charge

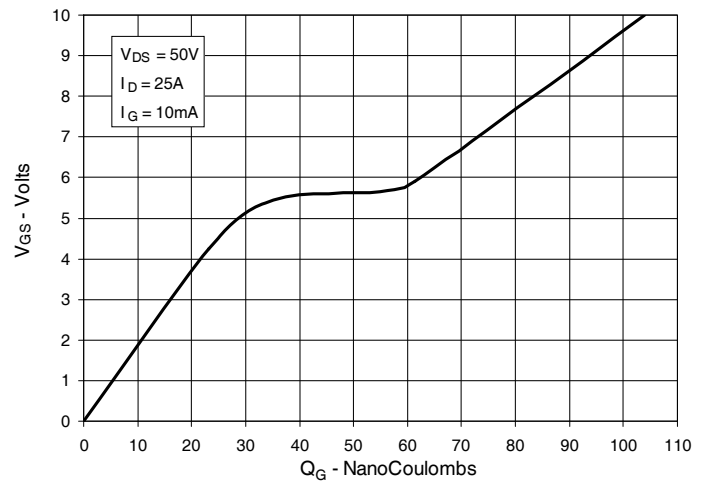

Fig. 11. Capacitance

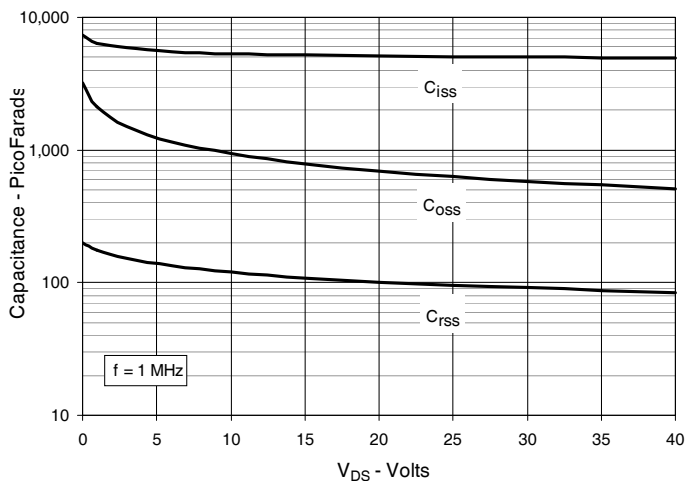

Fig. 12. Maximum Transient Thermal Impedance

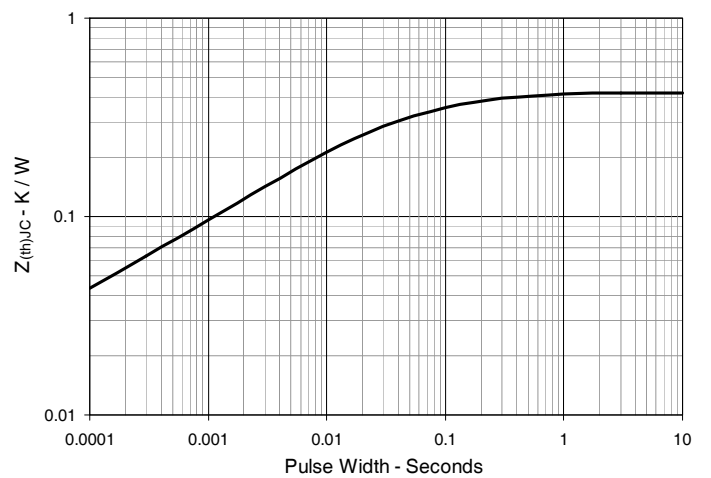

Fig. 13. Resistive Turn-on
Rise Time vs. Junction Temperature

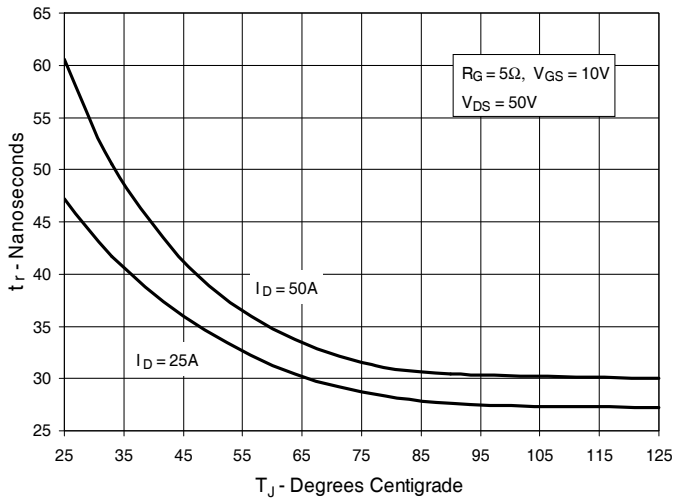

Fig. 14. Resistive Turn-on
Rise Time vs. Drain Current

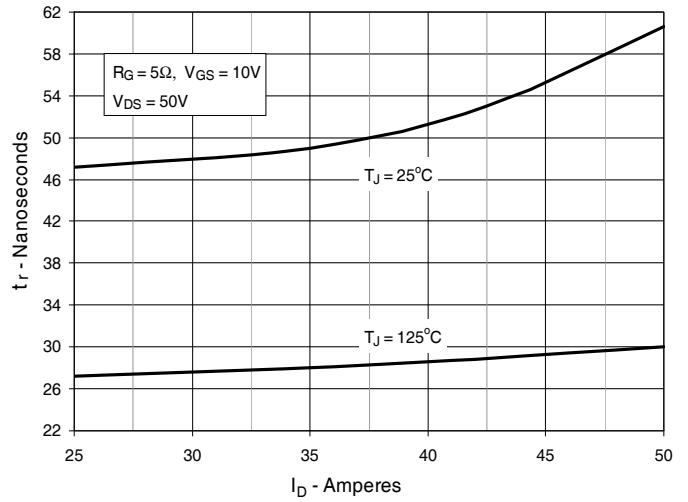

Fig. 15. Resistive Turn-on
Switching Times vs. Gate Resistance

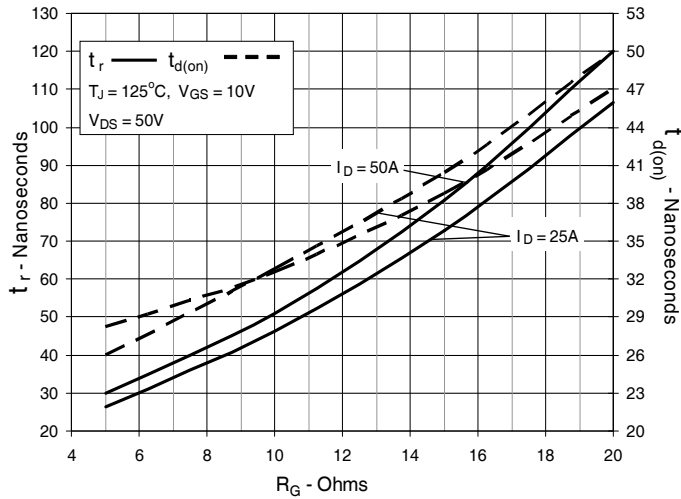

Fig. 16. Resistive Turn-off
Switching Times vs. Junction Temperature

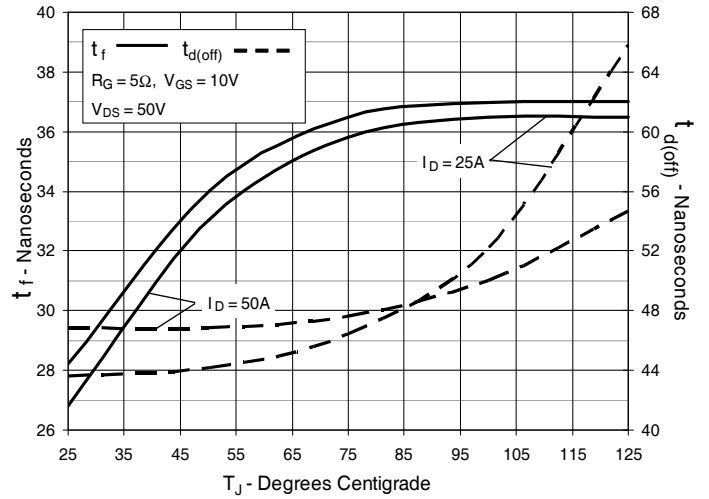

Fig. 17. Resistive Turn-off
Switching Times vs. Drain Current

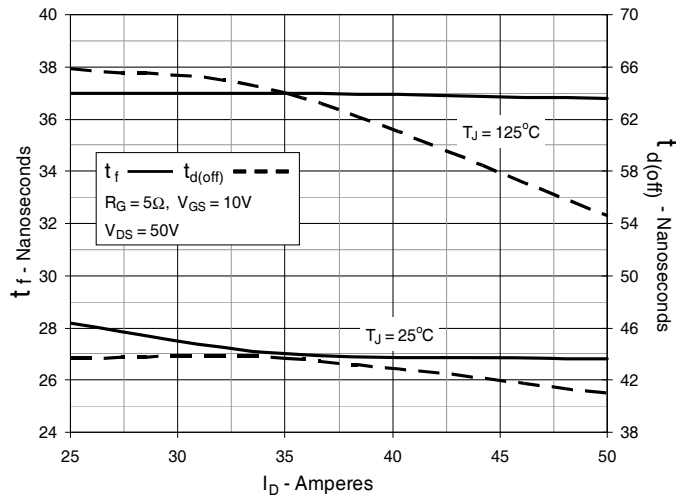
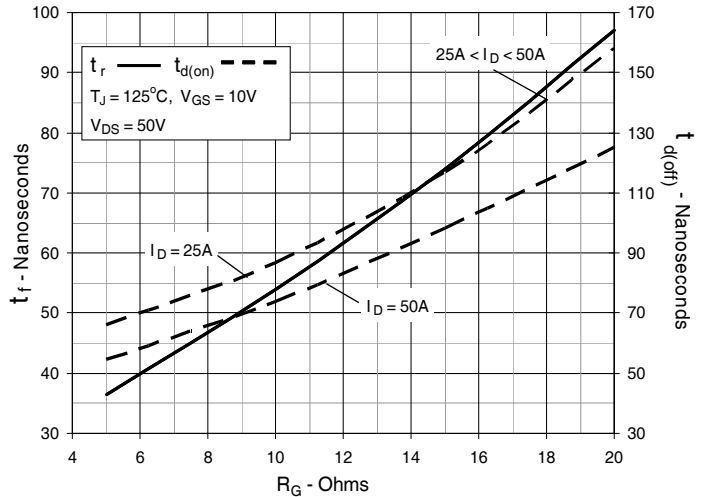

Fig. 18. Resistive Turn-off
Switching Times vs. Gate Resistance





Disclaimer Notice - Information furnished is believed to be accurate and reliable. However, users should independently evaluate the suitability of and test each product selected for their own applications. Littelfuse products are not designed for, and may not be used in, all applications. Read complete Disclaimer Notice at www.littelfuse.com/disclaimer-electronics.