

# Ultra Low Capacitance Diode Arrays Series

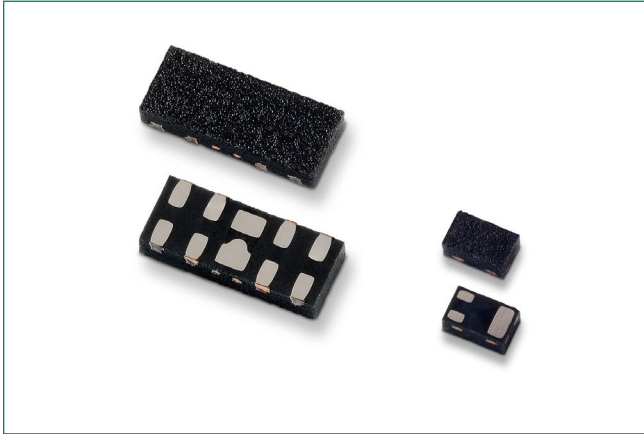

## Pinout

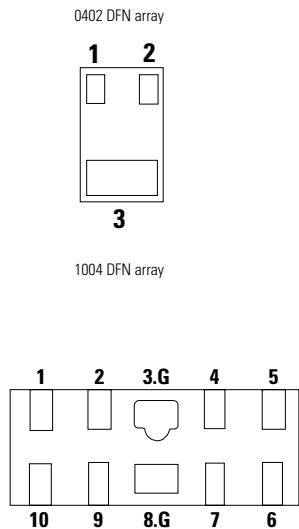

## Functional Block Diagram

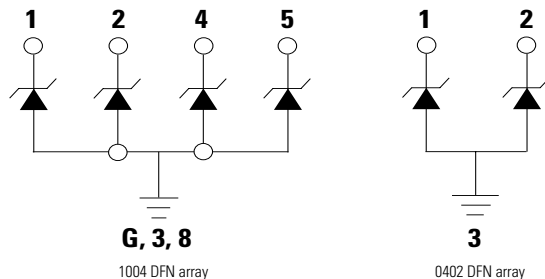

## Description

This Ultra Low Capacitance Diode Arrays Series provides signal integrity-preserving unidirectional ESD protection for the world's most challenging high speed serial interfaces. The SOD 883 and the standard 2.4 mm x 1.0 mm packaging options provide significant PCB layout space savings and reduces trace layout complexity. This component provides both air and contact ESD protection (IEC 61000-4-2) of 20 kV while maintaining an extremely low leakage current and low dynamic resistance. Due to its low off-state capacitance, this series is compatible with high speed interfaces and thus maintains high bandwidth signal integrity.

## Features

- 0.20 pF TYP capacitance
- ESD, IEC 61000-4-2,  $\pm 20$ kV contact,  $\pm 20$ kV air
- Low clamping voltage of 9.2V @ IPP=2.0A (tP=8/20 $\mu$ s)
- Low profile DFN array packages
- Facilitates excellent signal integrity
- ELV Compliant
- Halogen free, Lead free and RoHS compliant
- AEC-Q101 qualified (0402 DFN array)

## Applications

- USB 3.1, 3.0, 2.0
- HDMI 2.0, 1.4a, 1.3
- DisplayPort(TM)
- V-by-One®)
- Thunderbolt (Light Peak)
- LVDS interfaces
- Consumer, mobile and portable electronics
- Tablet PC and external storage with high speed interfaces
- Applications requiring high ESD performance in small packages

# Ultra Low Capacitance Diode Arrays Series

## Absolute Maximum Ratings

Symbol	Parameter	Value	Units
$I_{PP}$	Peak Current ( $t_p=8/20\mu s$ )	2.0	A
$T_{OP}$	Operating Temperature	-40 to 125	°C
$T_{STOR}$	Storage Temperature	-55 to 150	°C

**Caution:** Stresses above those listed in "Absolute Maximum Ratings" may cause permanent damage to the component. This is a stress only rating and operation of the component at these or any other conditions above those indicated in the operational sections of this specification is not implied.

## Electrical Characteristics - ( $T_{OP}=25^\circ C$ )

Parameter	Test Conditions	Min	Typ	Max	Units
Input Capacitance	@ $V_R = 0V$ , $f = 3GHz$		0.20	0.22	pF
Breakdown Voltage	$V_{BR}$ @ $I_T=1mA$		9.00		V
Reverse Working Voltage				7.0	V
Reverse Leakage Current	$I_L$ @ $V_{RWM}=5.0V$		25	50	nA
Clamping Voltage	$V_{CL}$ @ $I_{PP}=2.0A$		9.20		V
Peak Pulse Current	$t_p=8/20\mu s$			2.0	A
ESD Withstand Voltage	IEC 61000-4-2 (Contact)	$\pm 20$			kV
	IEC 61000-4-2 (Air)	$\pm 20$			

## Insertion Loss Diagram

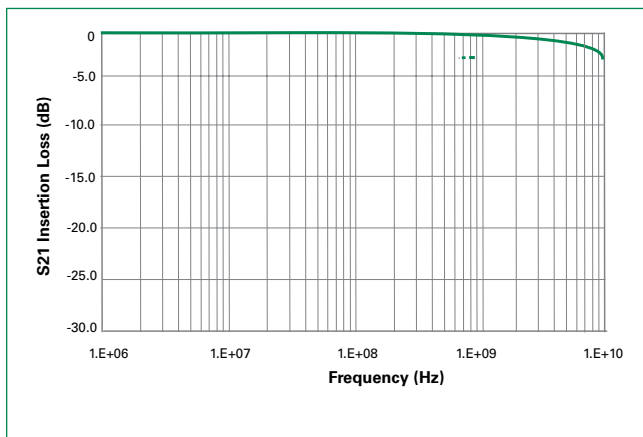

## Device IV Curve

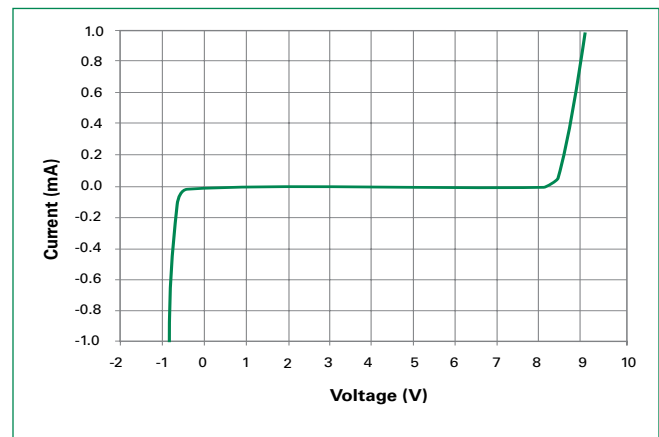

## TLP

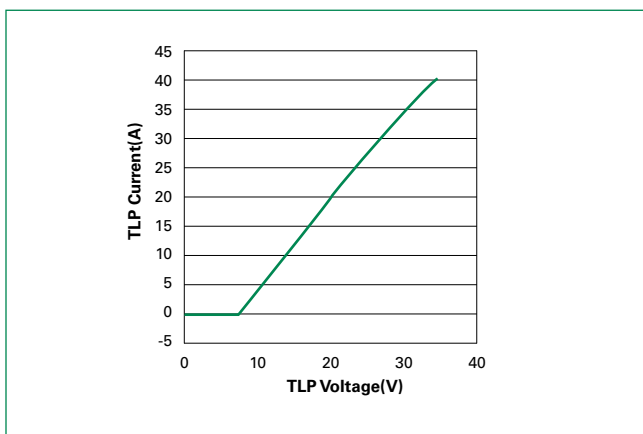

# Ultra Low Capacitance Diode Arrays Series

## USB3.0 Eye Diagram

5.0 Gb/s, 1000mV differential, CPO Compliant Test Pattern

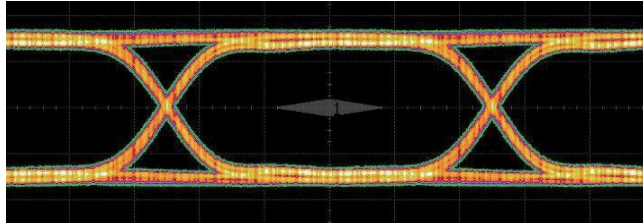

Without Component

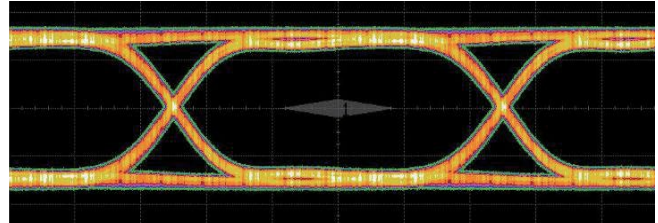

With Component

## Soldering Parameters

<b>Reflow Condition</b>	Pb – Free assembly	
<b>Pre Heat</b>	- Temperature Min ( $T_{s(min)}$ )	150°C
	- Temperature Max ( $T_{s(max)}$ )	200°C
	- Time (min to max) ( $t_p$ )	60 – 120 secs
<b>Average ramp up rate (Liquidus) Temp (<math>T_L</math>) to peak</b>	3°C/second max	
<b><math>T_{s(max)}</math> to <math>T_L</math> - Ramp-up Rate</b>	3°C/second max	
<b>Reflow</b>	- Temperature ( $T_L$ ) (Liquidus)	217°C
	- Temperature ( $t_L$ )	60 – 150 seconds
<b>Peak Temperature (<math>T_p</math>)</b>	260 <sup>+0/-5</sup> °C	
<b>Time within 5°C of actual peak Temperature (<math>t_p</math>)</b>	30 seconds	
<b>Ramp-down Rate</b>	6°C/second max	
<b>Time 25°C to peak Temperature (<math>T_p</math>)</b>	8 minutes Max.	
<b>Do not exceed</b>	260°C	

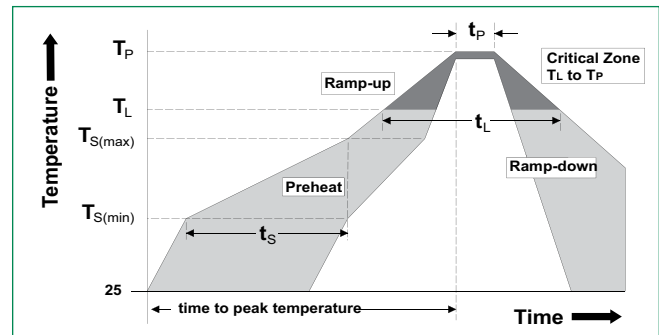

## Part Numbering System

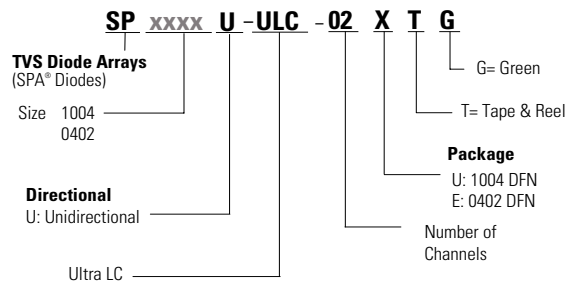

## Product Characteristics of 0402 DFN Package

<b>Lead Plating</b>	Pre-Plated Frame
<b>Lead Material</b>	Copper Alloy
<b>Lead Coplanarity</b>	0.004 inches(0.102mm)
<b>Substrate material</b>	Silicon
<b>Body Material</b>	Molded Epoxy
<b>Flammability</b>	UL Recognized epoxy meeting flammability rating V-0

**Notes :**

1. All dimensions are in millimeters
2. Dimensions include solder plating.
3. Dimensions are exclusive of mold flash & metal burr.
4. Blo is facing up for mold and facing down for trim/form, i.e. reverse trim/form.
5. Package surface matte finish VDI 11-13.

## Part Marking System



0402

1004

**Notes :**

For markings see Ordering Information table below

## Ordering Information

Part Number	Package	Reel Quantity
SP0402U-ULC-02ETG	0402 DFN Array	10000
SP1004U-ULC-04UTG	1004 DFN Array	3000

# Ultra Low Capacitance Diode Arrays Series

## Package Dimensions – 0402 DFN Array

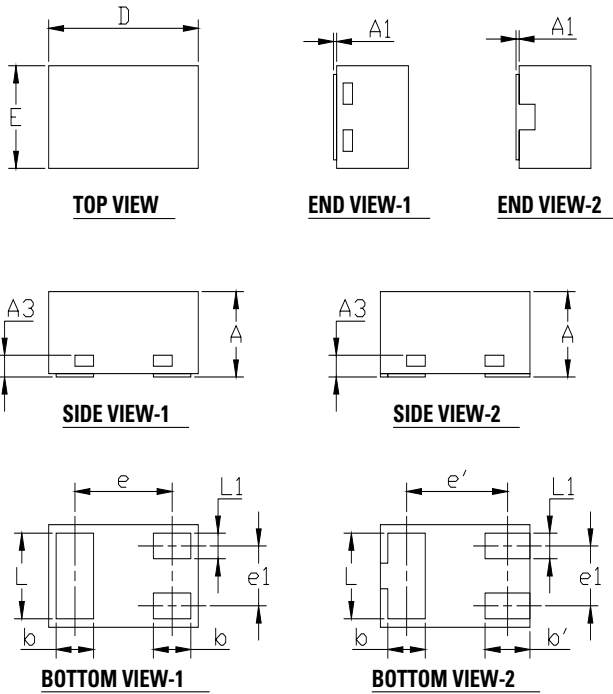

Symbol	Millimeters			Inches		
	Min	Typ	Max	Min	Typ	Max
A	0.33	-	0.55	0.013	0.015	0.022
A1	0	-	0.05	0	-	0.002
A3	0.13REF			0.005REF		
b	0.20	0.25	0.30	0.008	0.010	0.012
b'	0.20	0.30	0.40	0.008	0.012	0.016
D	0.95	1.00	1.05	0.037	0.039	0.041
E	0.55	0.60	0.65	0.022	0.024	0.026
e	0.65BSC			0.026BSC		
e'	0.675BSC			0.027BSC		
L	0.40	0.50	0.60	0.016	0.020	0.024
L1	0.10	0.15	0.20	0.004	0.006	0.008

### SOLDERING PATTERN

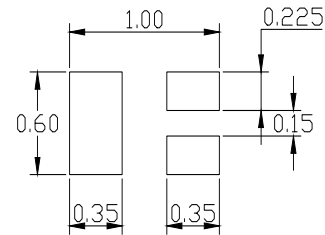

## Embossed Carrier Tape & Reel Specification – 0402 DFN Array

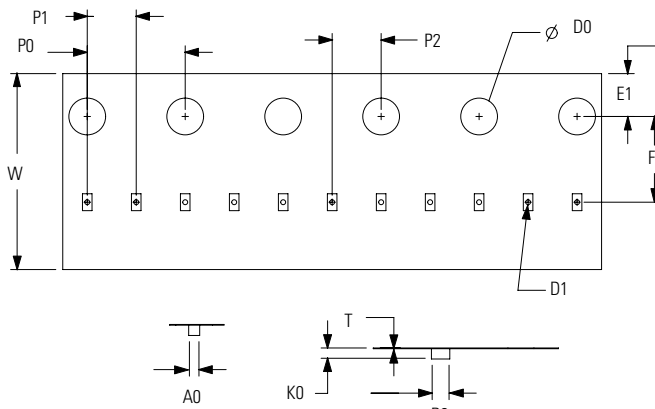

Symbol	Millimeters
A0	0.70+/-0.05
B0	1.15+/-0.05
D0	∅ 1.50+/-0.10
D1	∅ 0.40 +/-0.10
E1	1.75+/-0.10
F	3.50+/-0.10
K0	0.55+/-0.05
P0	4.00+/-0.10
P1	2.00+/-0.10
P2	2.00+/-0.05
W	8.00+0.30/-0.10
T	0.20+/-0.05

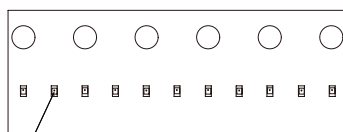

# Ultra Low Capacitance Diode Arrays Series

## Package Dimensions — 1004 DFN Array

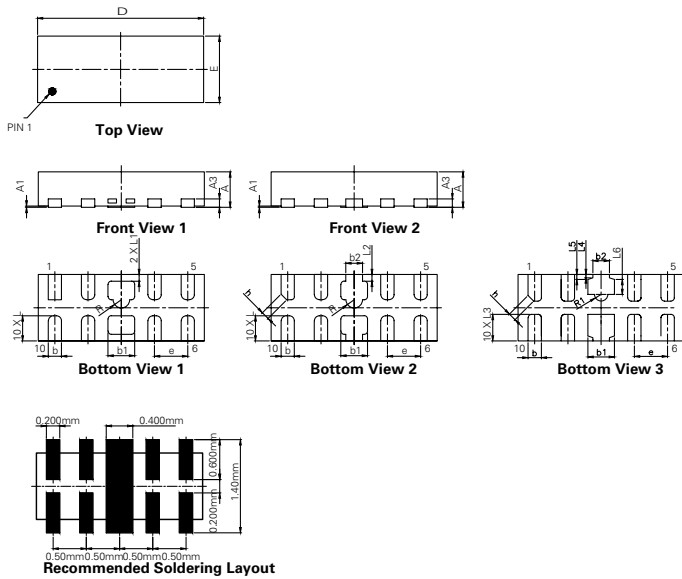

Symbol	Millimeters	
	Min	Max
<b>A</b>	0.40	0.60
<b>A1</b>	0.00	0.05
<b>A3</b>	0.120	0.175
<b>b</b>	0.15	0.25
<b>b1</b>	0.35	0.45
<b>b2</b>	0.20	0.30
<b>D</b>	2.40	2.60
<b>E</b>	0.90	1.10
<b>L</b>	0.28	0.48
<b>L1</b>	0.00	0.15
<b>L2</b>	0.05	0.15
<b>L3</b>	0.35	0.45
<b>L4</b>	0.050 REF	
<b>L5</b>	0.075 REF	
<b>L6</b>	0.225 REF	
<b>e</b>	0.500 BASIC	
<b>h</b>	0.6	0.16

## Embossed Carrier Tape & Reel Specification — 1004 DFN Array

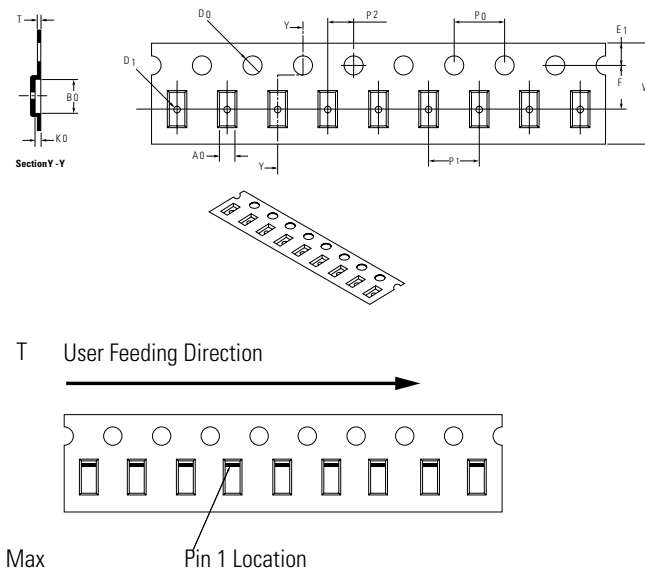

Symbol	Millimeters
<b>A0</b>	1.15 min/1.30 max
<b>B0</b>	2.70+/-0.05
<b>D0</b>	ø 1.50 min/1.65 max
<b>D1</b>	ø 0.50 min/1.05 max
<b>E1</b>	1.75+/-0.10
<b>F</b>	3.50+/-0.10
<b>K0</b>	0.65 min/0.75 max
<b>P0</b>	4.00+/-0.10
<b>P1</b>	4.00+/-0.10
<b>P2</b>	2.00+/-0.05
<b>W</b>	8.00+0.30/-0.10
<b>T</b>	0.17 min/0.30 max

**Disclaimer Notice** - Information furnished is believed to be accurate and reliable. However, users should independently evaluate the suitability of and test each product selected for their own applications. Littelfuse products are not designed for, and may not be used in, all applications. Read complete Disclaimer Notice at <http://www.littelfuse.com/disclaimer-electronics>.