

# ZCASE® Single MEGA

## Bolt-down Fuses – Rated 32 V DC

RoHS

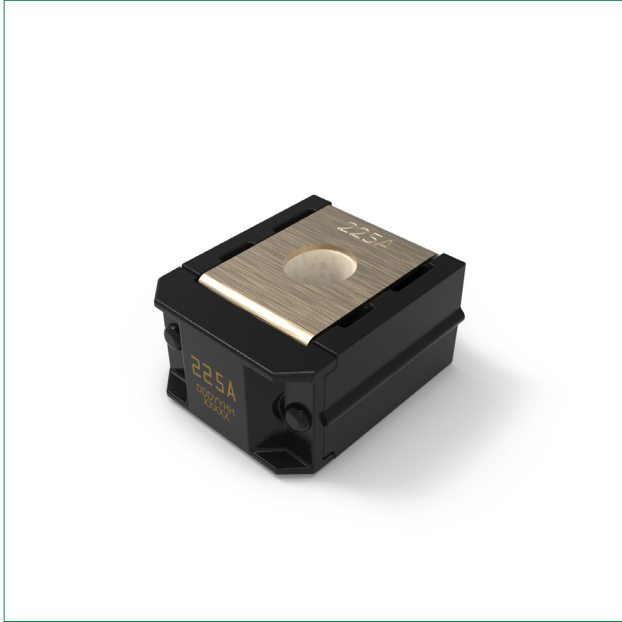

### Description

The Single ZCase is a Minimal Footprint Bolt Down Fuse with a wide rating range up to 600A in the same packaging size. The Time Current characteristic is similar to the well known MEGA Design and can be used as full wire protection until 250A. Higher ratings are mostly used for typically Starter Fuse applications as protector fuses. The fuse design is optimized for a one-bolt connection M6 (40A - 250A) or M8 (300A - 600A) and can be used directly on a battery post or busbar connection. Littelfuse is offering a complete solution for the necessary stud and different busbar connections including some battery clamps.

### Features & Benefits

- One-bolt connection
- SHUNT version available
- Can mount on a battery post, starter, or busbar
- High-contrast ampere rating stamp aids identification
- Compact design
- Space saving

### Applications

- Cars / SUVs
- Buses
- Trucks
- Watercraft as approved by Littelfuse®
- Offroad vehicles

[See Disclaimer Notice](#)

### Specifications

<b>Voltage Rating:</b>	32 V DC
<b>Interrupting Rating:</b>	2000 A @ 32 V DC
<b>Recommended Environmental Temperature:</b>	-40 °C to +125 °C
<b>Terminals Material:</b>	Tin-plated copper
<b>Housing Material:</b>	PPA-GF33HS (UL 94 Flammability rating of HB)
<b>Mounting Torque M6:</b>	9.8 Nm ± 1.4 Nm
<b>Mounting Torque M8:</b>	14 Nm ± 2 Nm
<b>Insulating Tube:</b>	Ceramic

### Additional Information



Resources



Samples

### Ordering Information

Part Number	Current Rating (A)	Package Size
3298XXX.ZXSTA	300 – 600	480
3298XXX.Z	40 – 250 SHUNT	480
3298XXX.H	40 – 600	100

# ZCASE® Single MEGA

## Bolt-down Fuses – Rated 32 V DC

### Ratings

Part Number	Current Rating (A)	Test Cable Size (mm <sup>2</sup> )	Typ. Voltage Drop (mV)	Typ. Cold Resistance (mΩ)	Typ. I <sup>2</sup> t (A <sup>2</sup> s)
3298040.Z / 3298040.H	40	4	86	1.53	5 000
3298060.Z / 3298060.H	60	6	83	0.98	18 000
3298080.Z / 3298080.H	80	10	80	0.72	15 500
3298100.Z / 3298100.H	100	16	88	0.57	31 000
3298125.Z / 3298125.H	125	16	71	0.39	45 000
3298150.Z / 3298150.H	150	25	83	0.32	75 000
3298175.Z / 3298175.H	175	25	82	0.26	140 000
3298200.Z / 3298200.H	200	35	92	0.23	235 000
3298225.Z / 3298225.H	225	35	86	0.18	95 000
3298250.Z / 3298250.H	250	50	88	0.17	160 000
3298300.ZXSTA / 3298300.H	300 <sup>1</sup>	35	29 <sup>2</sup>	0.13	310 000
3298350.ZXSTA / 3298350.H	350 <sup>1</sup>	35	30 <sup>2</sup>	0.10	570 000
3298400.ZXSTA / 3298400.H	400 <sup>1</sup>	50	30 <sup>2</sup>	0.08	870 000
3298500.ZXSTA / 3298500.H	500 <sup>1</sup>	50	34 <sup>2</sup>	0.07	1 550 000
3298600.ZXSTA / 3298600.H	600 <sup>1</sup>	50	362	0.05	3 000 000
3298900.Z /	SHUNT	50	-	-	-

**1:** STARTER fuses

**2:** Voltage Drop taken at 50% of Rated Current

**Note:** The typical I<sup>2</sup>t is an average value calculated from the breaking capacity tests by using the melting time before the arcing occurs.

### Dimensions

Dimensions in mm. Please refer to the outline drawing for dimensions and tolerances.

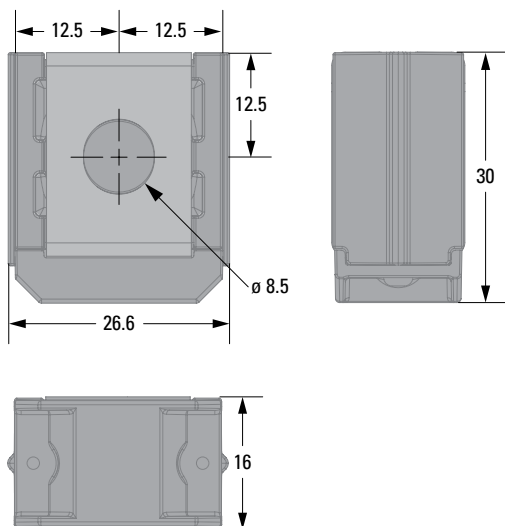

### Assembly Components Sold Separately

Part Number	Description
882-853	3-Way Bus Bar with M8 Insulating Bolts Assembly*
882-854	2-Way Bus Bar with M8 Insulating Bolts Assembly*
876-199	Battery Terminal Mount
32980001ZXM8	M8 Insulating Bolt



\*M8 Nuts not included

**Note:** Please contact your Littelfuse representative for application support and information on mating hardware.

# ZCASE® Single MEGA

## Bolt-down Fuses – Rated 32 V DC

### Time-Current Characteristic

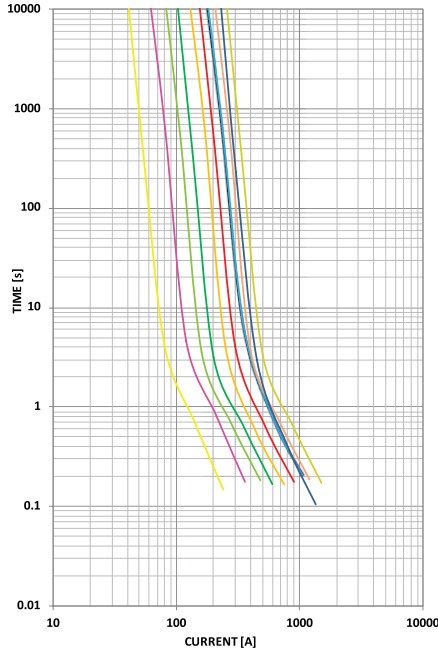

% of Rating	Opening Time Min. / Max. (s)		
	40 - 250 A	300 - 500 A	600 A
50	- / -	14 400 / -	14 400 / -
100	14 400 / -	- / -	- / -
135	120 / 1 800	- / -	- / -
200	1 / 15	1 / 40	1 / 40
350	0.3 / 5	0.3 / 5	0.3 / 5
500	- / -	- / -	0.1 / 1
600	0.1 / 1	0.1 / 1	- / -

- 40 A
- 60 A
- 80 A
- 100 A
- 125 A
- 150 A
- 175 A
- 200 A
- 225 A
- 250 A

**Note:** Current recommendation may be impacted by the final condition of the application (terminals characteristics, wire size etc.). Please contact Littelfuse® for more information.

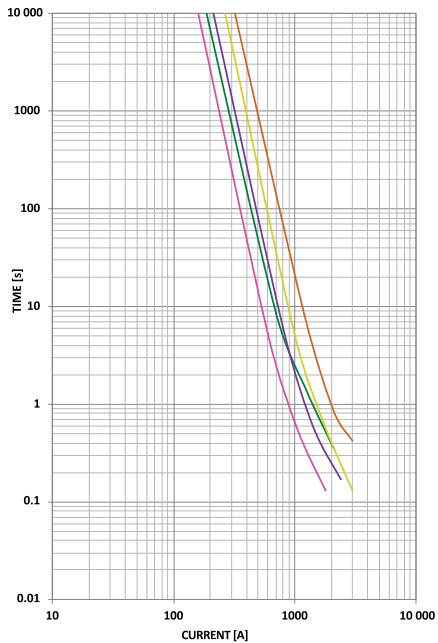

- 300 A
- 350 A
- 400 A
- 500 A
- 600 A

# ZCASE® Single MEGA

## Bolt-down Fuses – Rated 32 V DC

### Typical Derating Curves

Temperature security margin is 20%.

Please contact Littelfuse® for Details Regarding Derating Test Set Up.

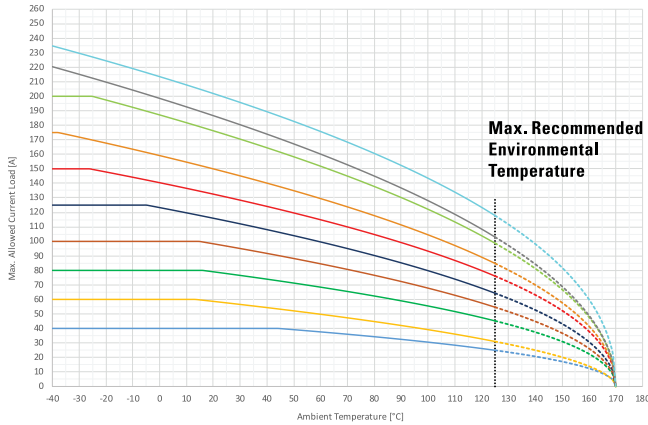

	Max. allowed current load (A) at ambient temperature based on typical derating						
	-40 °C	0 °C	20 °C	65 °C	85 °C	110 °C	125 °C
40 A	40	40	40	37	33	28	25
60 A	60	60	59	49	43	36	31
80 A	80	80	79	67	61	52	45
100 A	100	100	98	83	75	63	55
125 A	125	123	116	97	88	74	64
150 A	150	140	133	112	102	87	76
175 A	175	159	150	127	115	97	85
200 A	200	187	176	148	134	113	99
225 A	220	199	187	157	141	119	103
250 A	235	214	202	172	157	134	118
300 A	150	150	150	150	150	150	135
350 A	175	175	175	175	175	163	141
400 A	200	200	200	200	200	191	167
500 A	250	250	250	250	238	199	172
600 A	300	300	300	268	242	204	177

- 40 A
- 60 A
- 80 A
- 100 A
- 125 A
- 150 A
- 175 A
- 200 A
- 225 A
- 250 A

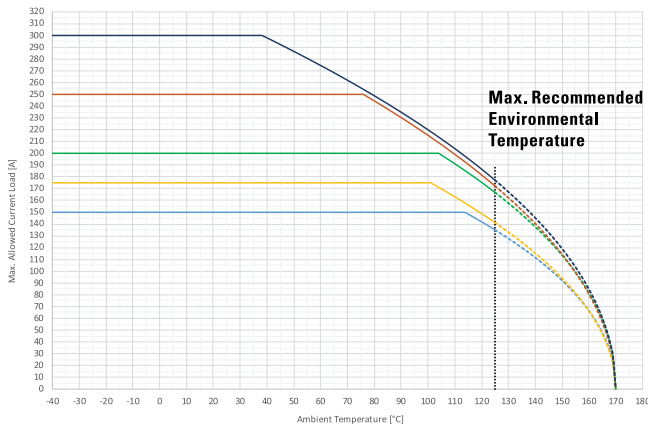

- 300 A
- 350 A
- 400 A
- 500 A
- 600 A

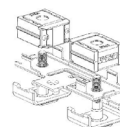

Zcase Mega Fixture

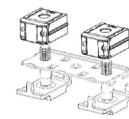

Zcase Starter Fixture

**Note 1:** All tests were performed on the left or right side of the metal bar as shown in the pictures. A 50mm<sup>2</sup> Cu wire was mounted at the mid hole (M8) as current feed.

**Note 2:** Current recommendation may be impacted by the final condition of the application (terminals characteristics, wire size etc..). Please contact Littelfuse® for more information.

**Disclaimer Notice** - Information furnished is believed to be accurate and reliable. However, users should independently evaluate the suitability of and test each product selected for their own applications. Littelfuse products are not designed for, and may not be used in, all applications. Read complete Disclaimer Notice at <https://www.littelfuse.com/legal/disclaimers/product-disclaimer.aspx>