

SMF4L-T1G Series

Surface Mount - 400 W, Low Leakage Performance



Additional Information



Resources



Accessories



Samples

Agency Approvals

Agency	Agency File Number
	E128662

Maximum Ratings & Thermal Characteristics

Parameter	Symbol	Value	Unit
Maximum P_{PK} Dissipation (PW-10/1000 μ s) ¹	P_{PK}	400	W
DC Power Dissipation @ $T_A = 25\text{ }^\circ\text{C}$ ²	P_D	385	mW
Derate Above 25 $^\circ\text{C}$		4.0	mW/ $^\circ\text{C}$
Thermal Resistance from Junction to Ambient ²	$R_{\theta JA}$	325	$^\circ\text{C}/\text{W}$
Thermal Resistance, Junction to Lead ³	$R_{\theta JL}$	26	$^\circ\text{C}/\text{W}$
Operating and Storage Temperature Range	T_J, T_{stg}	-55 to +150	$^\circ\text{C}$

Stresses exceeding Maximum Ratings may damage the component. Maximum Ratings are stress ratings only. Functional operation above the Recommended Operating Conditions is not implied. Extended exposure to stresses above the Recommended Operating Conditions may affect component reliability.

Notes:

1. Non-repetitive current pulse at $T_A = 25\text{ }^\circ\text{C}$
2. Mounted with recommended minimum pad size, DC board FR-4.
3. 1/2 sine wave (or equivalent square wave), PW = 8.3 ms, duty cycle = 4 pulses per minute maximum.

Description

The SMF4L-T1G series protects sensitive systems or components from high voltage, high energy transients. It offers a fast response time, low Zener impedance, high surge and excellent clamping capabilities. Because of its small size, it is ideal for use in cellular phones, portable devices, business machines, power supplies and other industrial and consumer applications.

Features & Benefits

- Zener transient overvoltage suppressors
- Working peak reverse voltage range 5 V to 78 V for uni-directional
- Peak power: 400 watts @ 10/1000 μ s
- Low leakage
- Response time is typically < 1 ns
- ESD rating of class 3 (> 16 kV) per human body model
- IEC-61000-4-2 ESD 30 kV(Air), 30 kV (Contact)
- Small footprint: SOD123FL package (footprint area of 8.45 mm²)
- Supplied in 8 mm tape and reel – 3,000 units per reel
- Lead orientation in tape: cathode lead to sprocket holes
- These components are Pb-free and are RoHS compliant
- UL Recognized compound meeting flammability rating V-0
- Recognized to UL 497Bas an Isolated Loop Circuit Protector

Applications

SMF4L-T1G Series is ideal for the protection of I/O interfaces, Vcc bus and other vulnerable circuit used in cellular phones, portable electronics, business machines, power supplies and other consumer applications. The low leakage is particularly well suited for battery operated electronics.

Functional Diagram

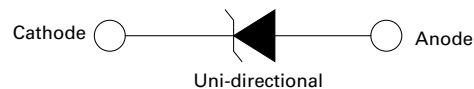

SMF4L-T1G Series

Surface Mount - 400 W, Low Leakage Performance

Electrical Characteristics

Part Number (Uni)	Marking	Working Peak Reverse Voltage V_{RWM} (V) ¹	Breakdown Voltage V_{BR} (V) @ I_T ²		Test Current I_T (mA)	Maximum Clamping Voltage V_C @ I_{PP} (V)	Maximum Peak Pulse Current I_{BP} (A)	Maximum Reverse Leakage I_R @ V_R (μ A)	Agency Approval 
			Min	Max					
SMF4L5.0AT1G	QE	5.0	6.40	7.00	10	9.2	43.5	50.0	x
SMF4L6.0AT1G	QG	6.0	6.67	7.37	10	10.3	38.8	50.0	x
SMF4L6.5AT1G	QK	6.5	7.22	7.98	10	11.2	35.7	40.0	x
SMF4L7.0AT1G	QL	7.0	7.78	8.60	10	12.0	33.3	40.0	x
SMF4L7.5AT1G	QN	7.5	8.33	9.21	1	12.9	31.0	30.0	x
SMF4L8.0AT1G	QR	8.0	8.89	9.83	1	13.6	29.4	5.0	x
SMF4L8.5AT1G	QT	8.5	9.44	10.40	1	14.4	27.8	5.0	x
SMF4L9.0AT1G	QV	9.0	10.00	11.10	1	15.4	26.0	0.5	x
SMF4L10AT1G	QX	10	11.10	12.30	1	17.0	23.5	0.5	x
SMF4L11AT1G	QZ	11	12.20	13.50	1	18.2	22.0	0.5	x
SMF4L12AT1G	RE	12	13.30	14.70	1	19.9	20.1	0.5	x
SMF4L13AT1G	RG	13	14.40	15.90	1	21.5	18.6	0.1	x
SMF4L14AT1G	RH	14	15.60	17.20	1	23.2	17.2	0.1	x
SMF4L15AT1G	RM	15	16.70	18.50	1	24.4	16.4	0.1	x
SMF4L16AT1G	RP	16	17.80	19.70	1	26.0	15.4	0.1	x
SMF4L17AT1G	RR	17	18.90	20.90	1	27.6	14.5	0.1	x
SMF4L18AT1G	RT	18	20.00	22.10	1	29.2	13.7	0.1	x
SMF4L20AT1G	RV	20	22.20	24.50	1	32.4	12.3	0.1	x
SMF4L22AT1G	RX	22	24.40	26.90	1	35.5	11.3	0.1	x
SMF4L24AT1G	RZ	24	26.70	29.50	1	38.9	10.3	0.1	x
SMF4L26AT1G	SE	26	28.90	31.90	1	42.1	9.5	0.1	x
SMF4L28AT1G	SG	28	31.10	34.30	1	45.4	8.8	0.1	x
SMF4L30AT1G	SK	30	33.30	36.80	1	48.4	8.3	0.1	x
SMF4L33AT1G	SM	33	36.70	40.60	1	53.3	7.5	0.1	x
SMF4L36AT1G	SP	36	40.00	44.20	1	58.1	6.9	0.1	x
SMF4L40AT1G	SR	40	44.40	49.10	1	64.5	6.2	0.1	x
SMF4L43AT1G	ST	43	47.80	52.80	1	69.4	5.8	0.1	x
SMF4L45AT1G	SV	45	50.00	55.30	1	72.7	5.5	0.1	x
SMF4L48AT1G	SX	48	53.30	58.90	1	77.4	5.2	0.1	x
SMF4L51AT1G	SZ	51	56.70	62.70	1	82.4	4.9	0.1	x
SMF4L54AT1G	TE	54	60.00	66.30	1	87.1	4.6	0.1	x
SMF4L58AT1G	TG	58	64.40	71.20	1	93.6	4.3	0.1	x
SMF4L60AT1G	TI	60	66.70	73.70	1	96.8	4.1	0.1	x
SMF4L64AT1G	TM	64	71.10	78.60	1	103.0	3.9	0.1	x
SMF4L70AT1G	RP	70	77.80	86.00	1	113.0	3.5	0.1	x
SMF4L75AT1G	TR	75	83.30	92.10	1	121.0	3.3	0.1	x
SMF4L78AT1G	TT	78	86.70	95.80	1	126.0	3.2	0.1	x

Notes:

1. A transient suppressor is normally selected according to the working peak reverse voltage (V_{RWM}), which should be equal to or greater than the DC or continuous peak operating voltage level
2. V_{BR} measured at pulse test current I_T at an ambient temperature of 25 °C

SMF4L-T1G Series

Surface Mount - 400 W, Low Leakage Performance

I-V Curve Characteristics ($T_A = 25\text{ }^\circ\text{C}$ unless otherwise noted, $V_F = 3.5\text{ V Max. @ } I_F = 30\text{ A}$)* For Uni-directional

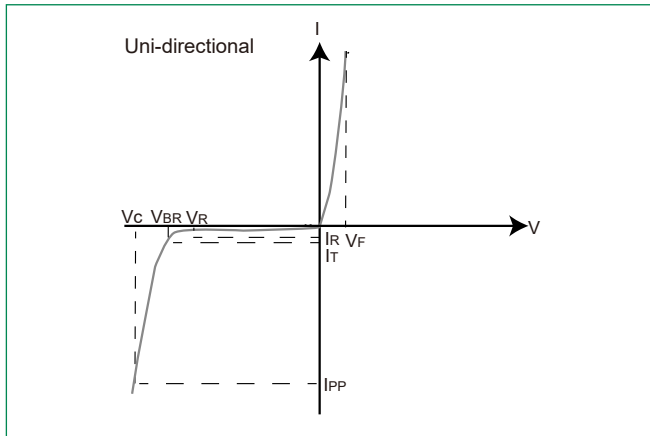

Symbol	Parameter
I_{PP}	Maximum Reverse Peak Pulse Current
V_C	Clamping Voltage @ I_{PP}
V_{RWM}	Working Peak Reverse Voltage
I_R	Maximum Reverse Leakage Current @ V_{RWM}
V_{BR}	Breakdown Voltage @ I_T
I_T	Breakdown Current Current
V_F	Forward Voltage @ I_F
I_F	Forward Current

Note: *1/2 sine wave (or equivalent square wave), PW = 8.3 ms, non-repetitive duty cycle.

Figure 1. Pulse Rating Curve

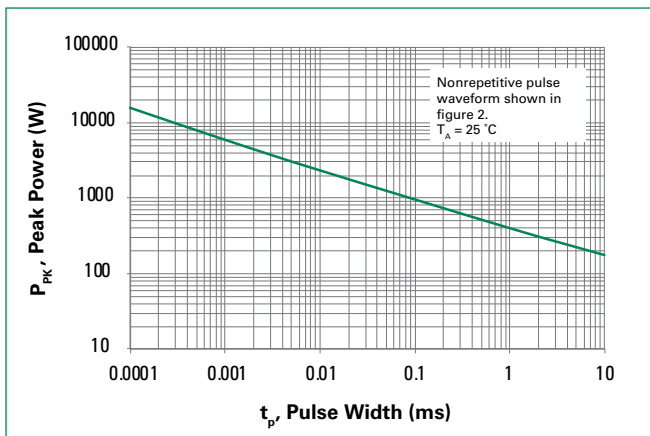

Figure 2. 10/1000 μs Pulse Waveform

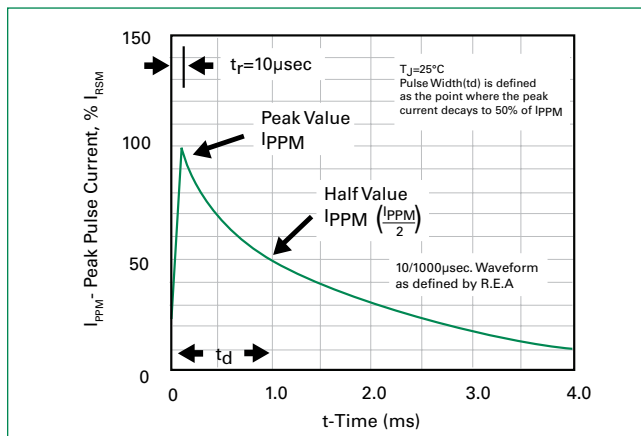

Figure 3. Typical Junction Capacitance vs. Bias Voltage

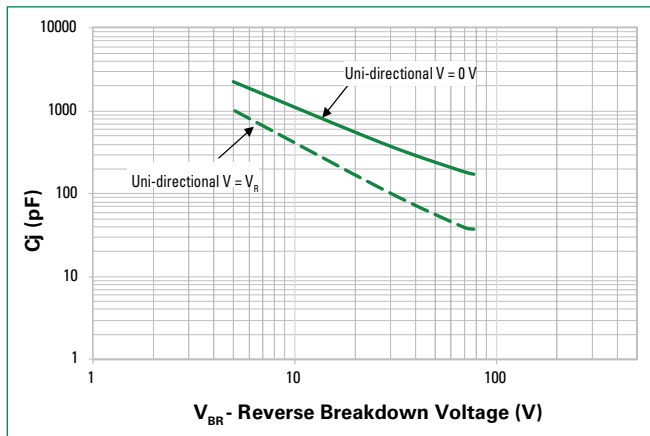
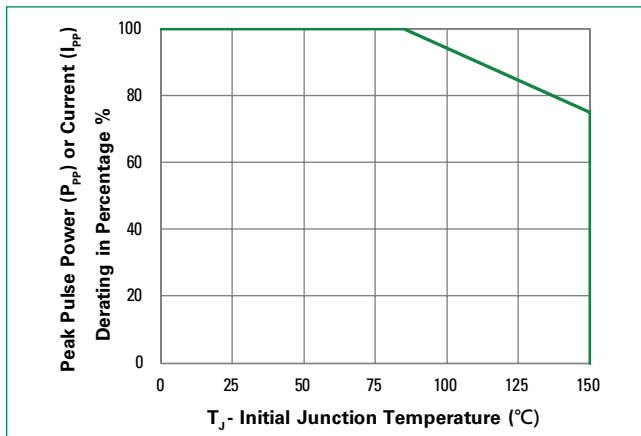

Figure 4. Surge Derating Curve



SMF4L-T1G Series

Surface Mount - 400 W, Low Leakage Performance

Soldering Parameters

Reflow Condition		Lead-free assembly
Pre Heat	- Temperature Min ($T_{s(min)}$)	150 °C
	- Temperature Max ($T_{s(max)}$)	200 °C
	- Time (min to max) (t_s)	60 – 120 seconds
Average Ramp Up Rate (Liquidus Temp (T_L) to Peak		3 °C/second max
$T_{s(max)}$ to T_L - Ramp-up Rate		3 °C/second max
Reflow	- Temperature (T_L) (Liquidus)	217 °C
	- Time (min to max) (t_s)	60 – 150 seconds
Peak Temperature (T_p)		260 ^{+0/-5} °C
Time within 5 °C of Actual Peak Temperature (t_p)		30 seconds max
Ramp-down Rate		6 °C/second max
Time 25 °C to Peak Temperature (T_p)		8 minutes max
Do Not Exceed		260 °C

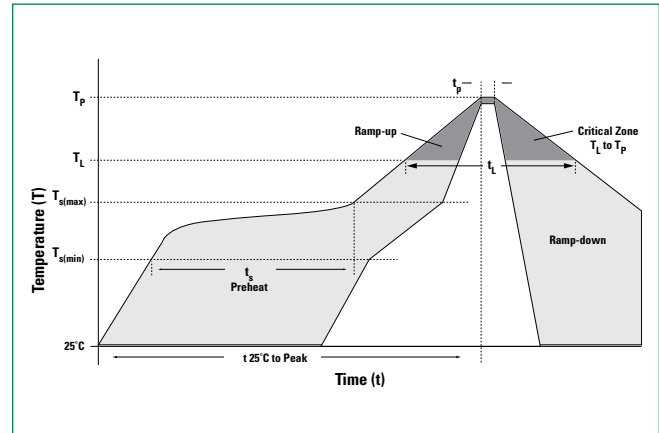

Physical Specifications

Weight	0.004 ounce, 0.0116 grams
Case	JEDEC SOD-123FL. Molded plastic body over glass passivated junction.
Polarity	Color band denotes cathode for unidirectional components.
Terminal	Matte Tin-plated leads, solderable per JESD22-B102

Environmental Specifications

High Temperature Storage	JESD22-A103
HTRB	JESD22-A108
Temperature Cycling	JESD22-A104
MSL	JEDEC-J-STD-020, Level 1
H3TRB	JESD22-A101
RSH	JESD22-A111

Dimensions

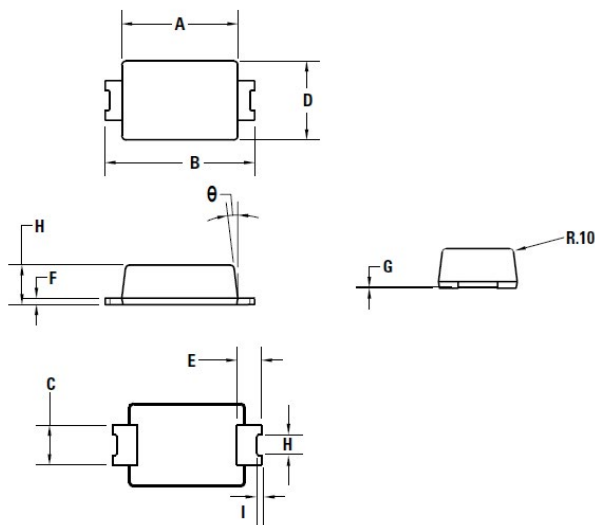

Mounting Pad Layout

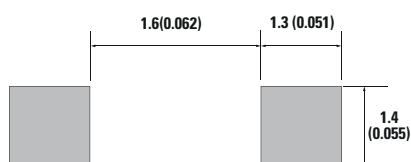

Dim	Millimeters		Inches	
	Min	Max	Min	Max
A	2.70	2.90	0.106	0.114
B	3.50	3.70	0.138	0.146
C	0.85	1.05	0.033	0.041
D	1.80	2.00	0.071	0.079
E	0.40	0.80	0.016	0.031
F	0.10	0.20	0.004	0.008
G	0.00	0.05	0.000	0.002
H	0.90	0.98	0.035	0.039
I	0.00	0.20	0.000	0.008
J	0.40	0.60	0.016	0.024
θ	0°	7°	0°	7°

Ordering Information

Device	Package	Shipping
SMF4LxxxAT1G	SOD-123FL (Pb-Free)	3,000 / Tape & Reel

SMF4L-T1G Series

Surface Mount - 400 W, Low Leakage Performance

Part Numbering System

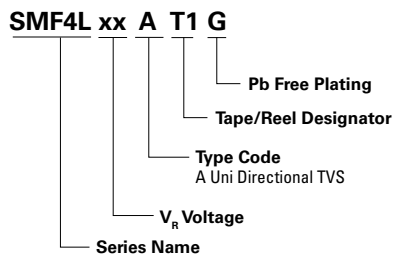

Part Marking System

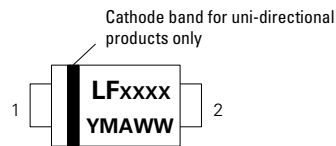

- XXX** =Device Code
- Y** =Year
- M** =Month
- A** =Assembly Location
- WW** =Lot Code

Tape and Reel Specification

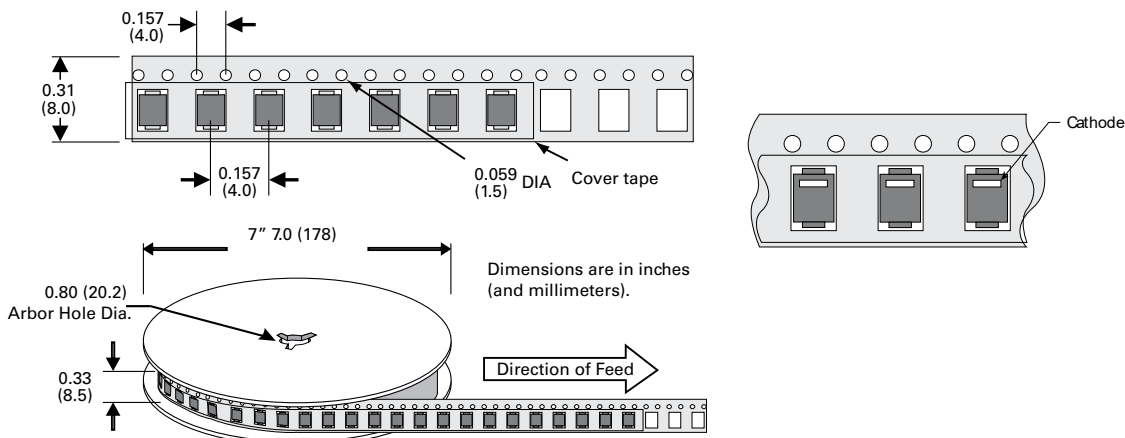

Disclaimer Notice - Information furnished is believed to be accurate and reliable. However, users should independently evaluate the suitability of and test each product selected for their own applications. Littelfuse products are not designed for, and may not be used in, all applications. Read complete Disclaimer Notice at <http://www.littelfuse.com/disclaimer-electronics>.