

SL1002A Series



Agency Approvals

AGENCY	AGENCY FILE NUMBER
	E128662

2 Electrode GDT Graphical Symbol



Additional Information



Datasheet



Resources



Samples

Description

The Broadband Optimized™ SL1002A series has been especially developed for use in broadband equipment. Special design features provide high levels of protection against fast rising transients in the 100V/μs to 1kV/μs range usually caused by lightning disturbances. These devices have ultra low capacitance (typically 1.2pF or less) and present insignificant signal losses up to 1.5GHz. These devices are extremely robust and are able to divert a 5000A pulse without destruction. For AC Power Cross of long duration, overcurrent protection is recommended.

Features

- RoHS compliant/Lead-free
- Ultra low insertion loss
- Surface mountable
- 5kA surge capability tested with 8/20μS–Pulse as defined by IEC 61000-4-5
- Excellent response to fast rising transients
- Can be used to meet Telcordia GR1089 without series resistance
- 10/700 6kV capability, as per ITU-T Rec. K.21, enhanced test level
- 2000 A 2/10μs surge rating
- Meet FCC part 68 10/160μs waveform, 200A test and 10/560μs waveform 100A test
- Halogen-free

Applications

- Broadband equipment
- ADSL equipment
- XDSL equipment
- Satellite and CATV equipment
- General telecom equipment

Electrical Characteristics

Part Number	Device Specifications (at 25°C)								Life Ratings						
	DC Breakdown in Volts ^{1,2} (@100V/s)			Impulse Breakdown in Volts ^{3,4} (@100V/μs)	Impulse Breakdown in Volts ^{3,4} (@1kV/μs)	Insulation Resistance	Capacitance (@1MHz 0V Bias)	Arc Voltage (on state voltage) @1Amp Min	Surge Life (@100A 10/1000μs)	Nominal Impulse Discharge Current (@20μs)	Nominal AC Discharge Current (10x1s @50-60Hz)	DC Holdover Voltage ⁵	Max Impulse Discharge Current (1 Application)		
	MIN	TYP	MAX	MAX		MIN	MAX	TYP				TYP	@ 2/10 μs	@ 10/350 μs	
SL1002A075	60	75	90	400	650	10 ⁹ Ω (at 50V)	1.2 pF	~15 V	300 shots ⁶	10 shots ⁷ (@ 5kA)	5 A	50 V	2 kA	1.5 kA	
SL1002A090	72	90	108									135 V			
SL1002A230	184	230	276	600	700							10 ⁹ Ω (at 100V)			135 V
SL1002A250	200	250	300												
SL1002A260	210	260	310	800	900							10 ⁹ Ω (at 500V)			135 V
SL1002A350	280	350	420												
SL1002A470	376	470	564	900	1000										
SL1002A600	480	600	720	1100	1200										
SL1002A600SP	570	600	780	1200	1300										

Notes:

- At delivery AQL 0.65 level II, DIN ISO 2859
- In ionized mode
- In ionized mode, tested according to ITU-T Rec. K.12
- Comparable to the silicon measurement Switching Voltage (Vs)
- Reference REA PE-80, 0.2A. Tested to ITU-T Rec. K.12 and REA PE-80 < 150 msecs.
- 300 Applications [150(+) & 150(-)]
- 10x[5x (+) & 5x (-)] Applications

Product Characteristics

Materials	Construction = Ceramic Insulator Device Finish = Dull Tin-plated 17.5 +/-12.5 microns
Product Marking	Littelfuse 'LF' Mark, voltage and date code

Glow to Arc Transition Current	< 0.5 Amps
Glow Voltage	~60 - 140 Volts
Storage and Operational Temperature	-40 to +90°C

Voltage vs. Time Characteristics

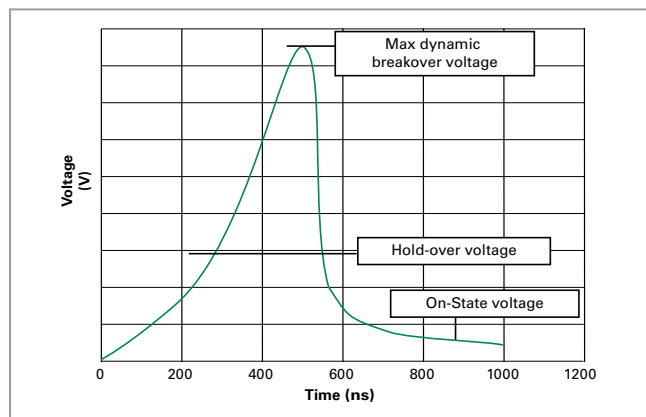

Insertion Loss Characteristics

Typical Insertion Loss Characteristics (90V)

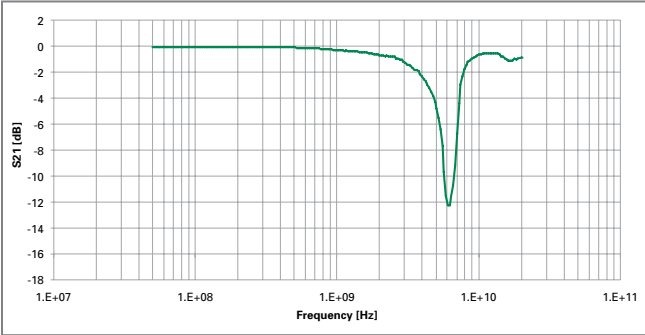

Typical Insertion Loss Characteristics (600V)

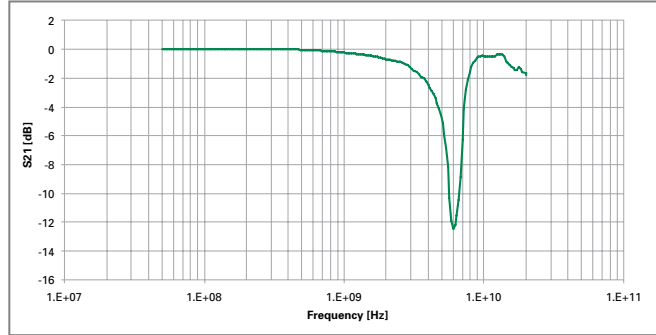

Device Dimensions

'C' Type Core Devices

Dimensions are in millimeters [and inches]

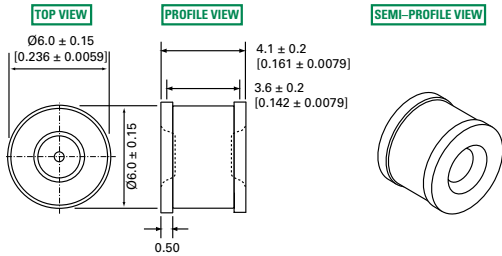

'SM' Type Surface Mount Devices

Dimensions are in millimeters [and inches]

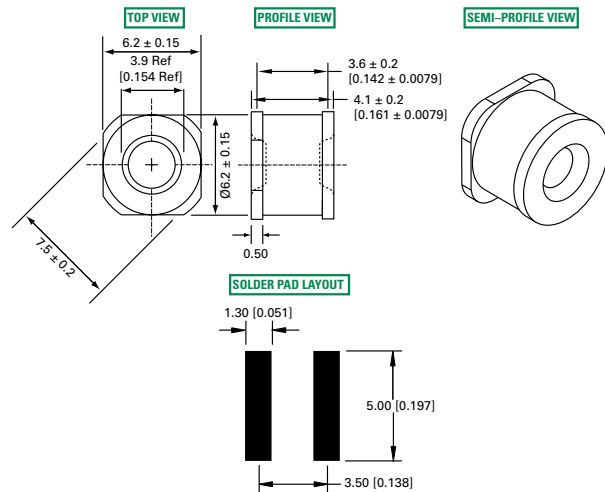

Soldering Parameters - Reflow Soldering (Surface Mount Devices)

Reflow Condition		Pb-free assembly
Pre Heat	- Temperature Min ($T_{s(min)}$)	150°C
	- Temperature Max ($T_{s(max)}$)	200°C
	- Time (Min to Max) (t_s)	60 – 180 seconds
Average Ramp-up Rate (Liquidus Temp (T_L) to peak)		3°C/second max.
$T_{s(max)}$ to T_L - Ramp-up Rate		5°C/second max.
Reflow	- Temperature (T_L) (Liquidus)	217°C
	- Temperature (t_L)	60 – 150 seconds
Peak Temperature (T_p)		260 ^{+0/-5} °C
Time within 5°C of Actual Peak Temperature (t_p)		10 – 30 seconds
Ramp-down Rate		6°C/second max.
Time 25°C to Peak Temperature (T_p)		8 minutes max.
Do not exceed		260°C

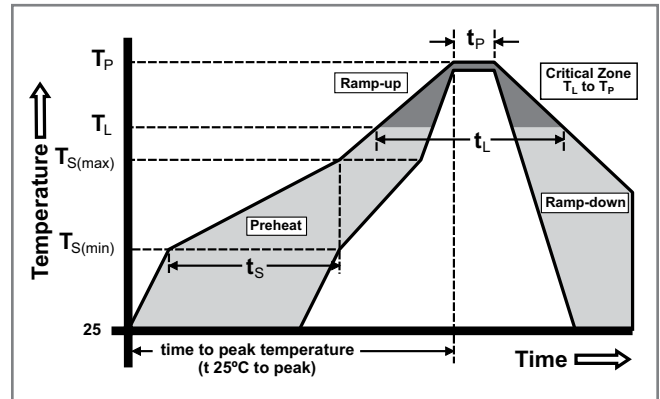

Soldering Parameters - Wave Soldering (Thru-Hole Devices)

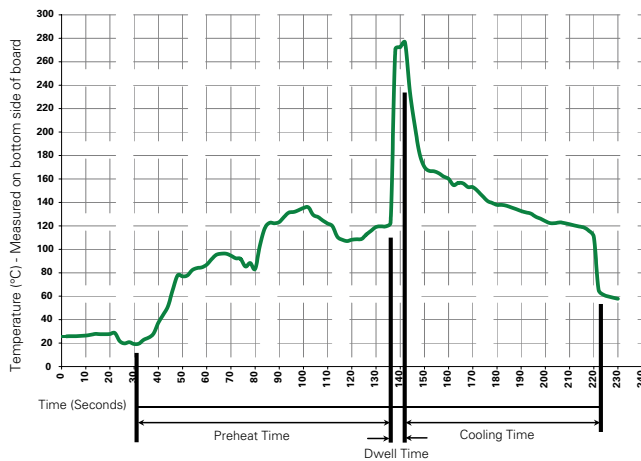

Recommended Process Parameters:

Wave Parameter	Lead-Free Recommendation
Preheat: (Depends on Flux Activation Temperature) (Typical Industry Recommendation)	
Temperature Minimum:	100° C
Temperature Maximum:	150° C
Preheat Time:	60-180 seconds
Solder Pot Temperature:	280° C Maximum
Solder Dwell Time:	2-5 seconds

Soldering Parameters - Hand Soldering

Solder Iron Temperature: 350° C +/- 5°C
 Heating Time: 5 seconds max.

Packaging

'C' Type Core Items: Package bulk pack in polybag, 1000 pcs/bag

'SM' Type Surface Mount Items: Packaged tape and reel carrier, 1000 pcs/reel (specifications below)

Dimensions are in millimeters [and inches]

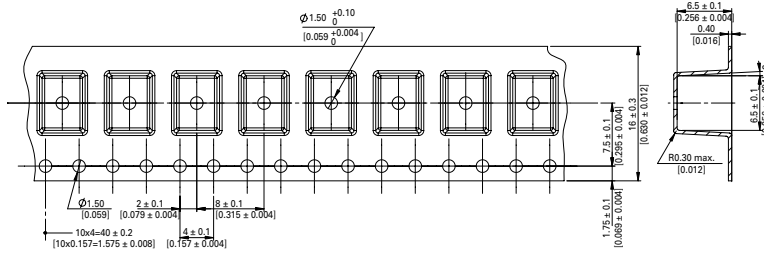

Dimensions are in millimeters [and inches]

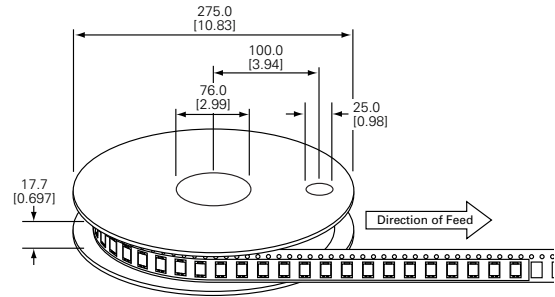

Part Numbering System and Ordering Information

SL1002 A XXX XX

Surge Capability

Voltage

Pin Configuration

C = Core (Packed in polybag, 1000pcs/bag)

SM = Surface Mount (Packed in carrier and tape, 1000pcs/reel)

Disclaimer Notice - Information furnished is believed to be accurate and reliable. However, users should independently evaluate the suitability of and test each product selected for their own applications. Littelfuse products are not designed for, and may not be used in, all applications. Read complete Disclaimer Notice at: www.littelfuse.com/disclaimer-electronics.