

INSTALLATION INSTRUCTIONS FOR SYMCOM'S MOTORSAVER® MODEL 460L

**BE SURE POWER IS DISCONNECTED PRIOR TO INSTALLATION!!
FOLLOW NATIONAL, STATE AND LOCAL CODES!**

CONNECTIONS

1. Mount the MOTORSAVER® in a convenient location in or near the motor control panel. If the location is wet or dusty, then the MOTORSAVER® should be mounted in a NEMA 4 or 12 enclosure. The 460L can be mounted to a back panel using two #6 or #8 x 5/8 screws or can be snapped on to a DIN rail.
2. Connect L1, L2 and L3 on the MotorSaver's terminal strip to the LINE SIDE of the motor starter. (See Figure No. 1).
3. Connect the output relay to the circuitry to be controlled. Connect the normally open contact in series with the magnetic coil of the motor starter as shown in Figure No. 1 for motor control. Connect normally closed contact in control circuit as shown in figure No. 2 for alarm operation.

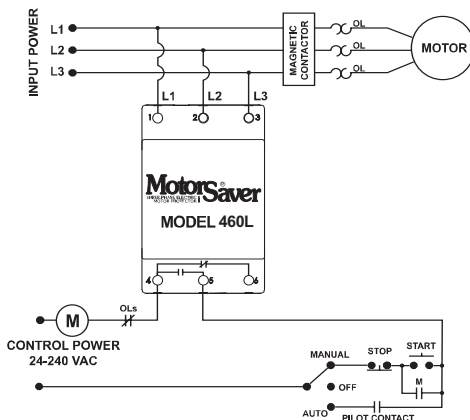

Figure No. 1: Motor Control Wiring Diagram

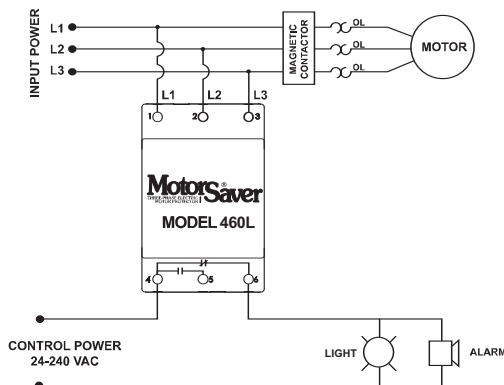

Figure No. 2: Alarm Wiring Diagram

II-460-L-B



SETTINGS

1. **LINE VOLTAGE ADJUSTMENT:** Rotate the LINE VOLTAGE ADJUSTMENT to the nominal three-phase line voltage feeding the motor to be protected. The Model 460L will automatically sense whether it is connected to a 200V or 400V 60 Hz or 380V - 416V 50Hz power system.
2. **RESTART delay:** Rotate the RESTART delay to the desired position. The restart delay is the time between the MOTORSAVER® seeing acceptable power and the MOTORSAVER® closing its output contacts. For compressor applications, the restart delay should be set for the approximate time it takes for the head pressure to bleed off of the compressor. For other applications, the restart delay is typically set at 2 seconds.

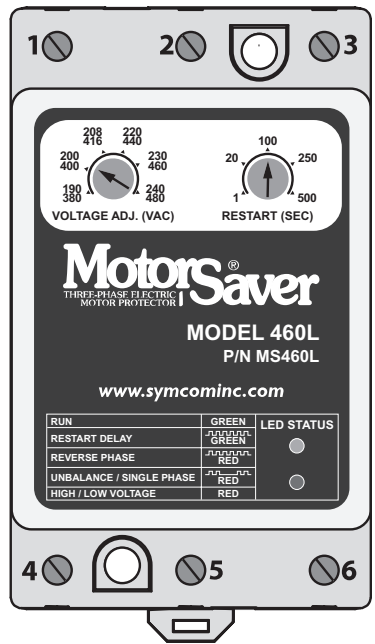





POWER-UP

Turn on the power to the motor. The green RUN LIGHT will blink during the RESTART delay. After the RESTART delay, the MOTORSAVER® will energize its output contacts and the green RUN LIGHT will light. If the contacts do not energize and the RUN LIGHT does not light, then see the TROUBLESHOOTING section.

**CONGRATULATIONS!!! YOU HAVE JUST INSTALLED
THE FINEST MOTOR PROTECTION AVAILABLE!**

HAVE QUESTIONS? CALL 1-800-843-8848



TROUBLESHOOTING

SYMPTOM	LIGHT PATTERN	SOLUTION
No lights are on. The unit seems completely dead.	NA	Measure the three line-to-line voltages. If any of the voltages are below 150 VAC, the Model 460L does not have enough power to operate its internal electronics. This may occur on a single-phased system. If the voltages are correct, call SymCom @ 1-800-843-8848.
Red light is blinking on initial installation power up.	 RED	Turn off the three-phase power. Swap any two leads powering the Model 460L: L1, L2 or L3. You have a 50-50 chance of connecting L1, L2 and L3 up correctly the first time. Turn on the three-phase power.
Red light is blinking after the motor has been previously running.	 RED	The incoming lines have been reverse phased. Swap any two incoming power lines to the magnetic contactor.
Red light is blinking in this pattern.	 RED	Indicates voltage unbalance. Measure incoming line voltages and calculate % unbalance as shown below. If voltage unbalance does not exceed the 4.5% unbalance set on the front call SymCom at 1-800-843-8848.
Red light is on steady.	NA	Measure the three line-to-line voltages. Calculate the average of the three voltages. If the average is outside of $\pm 7\%$ of the nominal voltage as set by LINE VOLTAGE ADJUST, then the Model 460L is functioning properly. If the voltage is within the reset window, call SymCom @ 1-800-843-8848.
Green light blinks but motor does not start.	 GREEN	The Model 460L is in restart delay.
Green light is on steady but motor does not start.	NA	Check control circuit for loose wires or malfunctioning switches.

NEMA MG1 UNBALANCE FORMULA

$$\% \text{ Voltage Unbalance} = [(\text{Maximum Deviation from the Average}) / \text{Average}] \times 100\%$$

INDICATOR LIGHT DIAGNOSTICS

RUN	GREEN
RESTART DELAY	 GREEN
REVERSE PHASE	 RED
UNBALANCE / SINGLE PHASE	 RED
HIGH / LOW VOLTAGE	RED

Specifications

3-Phase Line Voltage	190 - 480 VAC (475 - 600 VAC Optional) (95 - 120 VAC Optional)
Frequency	50* or 60 Hz
Low Voltage (% of set point)	
•Trip	90% ±1%
•Reset	93% ±1%
High Voltage (% of set point)	
•Trip	110% ±1%
•Reset	107% ±1%
Voltage Unbalance (NEMA)	
•Trip	6%
•Reset	4.5%
Trip Delay Time	
•Low & High Voltage and Unbalance	4 seconds
•Single Phasing Faults (>25% UB)	1 second
Restart Delay Time	
•After a Fault	1 - 500 seconds adjustable
•After a Complete Power Loss	1 - 500 seconds adjustable
Output Contact Rating	
•1-Form C	10 A General Purpose @240 VAC Pilot Duty 480VA @ 240 VAC, B300
Power Consumption	6 Watts (Max.)
Weight	14 oz.
Enclosure	polycarbonate
Terminal Torque	6lbs-in.
Wire Type	Stranded or solid 12-20 AWG, one per terminal
Safety Marks	
•UL	UL508
•CE	IEC 60947-6-2
Standards Passed	
•Electrostatic Discharge (ESD)	IEC 1000-4-2, Level 3, 6kV contact, 8kV air
•Radio Frequency Immunity, Radiated	150 MHz, 10V/m
•Fast Transient Burst	IEC 1000-4-4, Level 3, 3.5 kV input power & controls
Surge	
•IEC	IEC 1000-4-5, Level 3, 4kV line-to-line; Level 4, 4kV line-to-ground
•ANSI/IEEE	C62.41 Surge and Ring Wave Compliance to a level of 6kV line-to-line
•Hi-potential Test	Meets UL508 (2 x rated V +1000V for 1 minute)
Environmental	
Temperature Range	Ambient Operating: -20° - 70° C (-4° - 158°F) Ambient Storage: -40° - 80° C (-40° - 176°F)
Class of Protection	IP20, NEMA 1 (FINGER SAFE)
Relative Humidity	10-95%, non-condensing per IEC 68-2-3

*Note: 50 Hz will increase all delay timers by 20%

SymCom warrants its microcontroller based products against defects in material or workmanship for a period of five (5) years from the date of manufacture. All other products manufactured by SymCom shall be warranted against defects in material and workmanship for a period of two (2) years from the date of manufacture. For complete information on warranty, liability, terms, returns, and cancellations, please refer to the SymCom Terms and Conditions of Sale document.