

CONNESSIONI ELETTRICHE TRA VEICOLO E RIMORCHIO

ELECTRICAL CONNECTIONS BETWEEN VEHICLE AND TRAILER
ELEKTRISCHE VERBINDUNGEN ZWISCHEN ZUGFAHRZEUG UND ANHÄNGER
CONNEXIONS ELECTRIQUES ENTRE VEHICULE ET REMORQUE

2016



Cert. n° 023116



Cert. n° 250514

Azienda certificata

ISO TS 16949

Certificato

n° IATF 0203008



Net
THE INTERNATIONAL CERTIFICATION NETWORK

INERIS
04ATEXQ405

member's 
CONNECTING POWER



2016

**CONNESSIONI ELETTRICHE
TRA VEICOLO E RIMORCHIO**

**ELECTRICAL CONNECTIONS BETWEEN VEHICLE AND TRAILER
ELEKTRISCHE VERBINDUNGEN ZWISCHEN ZUGFAHRZEUG UND ANHÄNGER
CONNEXIONS ELECTRIQUES ENTRE VEHICULE ET REMORQUE**



La MEMBER'S S.p.A., fondata nel 1965, opera da oltre 30 anni nel settore dei **ricambi** e della **componentistica per autoveicoli** producendo articoli per il **1° Equipaggiamento** e per il mercato del **Ricambio**. Lo Stabilimento copre una superficie di 10.000 mq., su un totale di 40.000 mq., comprendenti i reparti di produzione (torneria, tranceria ed assemblaggio), gli uffici per la progettazione ed i laboratori di sperimentazione e controllo in grado di soddisfare esigenze specifiche poste dai Costruttori di autoveicoli.

MEMBER'S S.p.A. oltre ad avere ottenuto la certificazione **UNI EN ISO 9001 nel 1994**, la certificazione **ISO TS 16949 nel 2003**, la certificazione **ATEX INERIS nel 2004** e la certificazione relativa alla **Gestione Ambientale nel 2005**, vanta il riconoscimento come **Fornitore qualificato** da parte dei più importanti costruttori a livello mondiale (VOLVO-RENAULT V.I., FIAT-IVECO, HALDEX, TRW, M.A.N., VALEO).

Grazie alla combinazione ottimale di tutti questi fattori e ad una efficace e razionale organizzazione commerciale la MEMBER'S S.p.A. distribuisce i suoi prodotti in tutto il mondo distinguendosi ed imponendosi per efficienza ed innovazione, qualità ed affidabilità.

La nostra produzione

Prese e spine 12V. e 24V., spirali elettriche e cablaggi vari per rimorchi industriali, agricoli, carrelli e caravans. **Presa-spina "ABS"**. Presa-spina 13 poli 12V. Presa-spina 15 poli 24V. **Teleruttori generali di corrente elettrici ed elettronici ADR per trasporto merci pericolose**. Moduli accensione elettronica. Interruttori meccanici a puntale. Portaspazzole, regolatori elettronici, ponti diodi, ricambi vari per alternatori. Elettromagneti, calotte, ricambi vari per motorini d'avvicinamento. Portafusibili volanti, interruttori staccabatteria, ammortizzatori per fanali, articoli complementari per l'impianto elettrico degli autoveicoli.



*1965-established MEMBER'S S.p.A. has been operating in the field of **spare parts** and **components** for **motor vehicles** for over 30 years : now it is a well-founded manufacturer of products for the Automotive **Original Equipment** Manufacturing (O.E.M.) and the **After Market** (A.M.). MEMBER'S plants cover a total area of sq.mt. 40,000 (of which sq.mt. 10,000 are covered) including three main machining departments (turning, stamping and assembling), a product engineering department, and laboratories for experimenting and checking of products.*

*All these facilities enable MEMBER'S S.p.A. to meet any special requirements from motor vehicles' makers. Besides holding the certifications to **UNI EN ISO 9001 standard since 1994** and **ISO TS 16949 standard since 2003**, we have achieved registration to **ATEX/INERIS standard in 2004** and we are also certified according to the **Environmental Management System Standard**. MEMBER'S is a "**Qualified Supplier**" to the most important automotive makers (such as VOLVO-RENAULT V.I., FIAT-IVECO, HALDEX, TRW, M.A.N., VALEO).*

Factors mentioned above combined with a highly efficient and sensible marketing network allow MEMBER'S S.p.A. to distribute its products all over the world and especially to stand out and become very popular by efficiency and innovation, quality and reliability.

Our production

12V. and 24V. electric sockets-plugs, electric spiral coils and various harnesses for industrial and agricultural trailers, trolleys and caravans. **"ABS" plug-socket**. 13-pin socket-plug 12V. 15-pin socket-plug 24V. **ADR electrical and electronical battery switches suitable for transport of dangerous goods**. Ignition modules. Mechanical switches.

Brush-holders, electronic regulators, diode bridges, various spare parts for alternators. Starter solenoid switches, ignition distributor caps, various spare parts for starters. Fuseholders, battery switches, shockabsorbers for lights, complementary articles for the electric system of motor vehicles.



MEMBER'S S.p.A wurde 1965 gegründet und ist seit über 30 Jahren im **Ersatzteil- und Autozubehörsbereich** tätig. Wir produzieren sowohl Artikel zur **Erstausstattung** als auch für den **Ersatzteilmarkt**. Unser Firmengelände besteht aus insgesamt 40000 qm; die Firmengebäude verteilen sich über 10000qm: Werkhallen, Produktionsabteilungen (Dreherei, Stanzerei und Zusammenbau), technische Projektteilungen sowie Test- und Prüfungslabors. Letztere beschäftigen sich mit spezifischen Anforderungen von Automobilherstellern, denen unsere Produkte gerecht werden müssen/entsprechen müssen. Zusätzlich zur jeweils in **1994** und **2003** bereits erhaltenen **UNI EN ISO 9001** und **ISO TS 16949 Zertifizierungen**, ist MEMBER'S auch nach der **ATEX Richtlinie** zertifiziert. Zudem hat unsere **Firma die Umweltmanagement-Bescheinigung** erzieht. MEMBER'S ist stolz darauf, als **Qualitätslieferant** von den renommiertesten Produktionsfirmen weltweit (VOLVO-RENAULT V.I., FIAT-IVECO, HALDEX, TRW, M.A.N, VALEO) anerkannt zu sein. Dank der optimalen Kombination dieser Faktoren und einer effizienten und rationalisierten Vermarktungsstrategie werden Member's Produkte weltweit verkauft. Effizienz und Innovation gepaart mit Qualität und Zuverlässigkeit sind Merkmale, die uns von anderen unterscheiden, und mit denen wir uns erfolgreich auf dem Markt durchgesetzt haben.

Aus unserer Produktion

12V und 24V Steckdosen und Stecker, Spiralkabel und Kabel für Anhänger von Industriefahrzeugen, landwirtschaftlichen Fahrzeugen, für Gabelstapler und Caravans. **"ABS" Steckdosen und Stecker**. 12V Steckdosen und Stecker 13-polig. 24V Steckdosen und Stecker 15 polig. **Elektrische und elektronische ADR Hauptstromfernswitcher für Gefahrguttransport**. Elektronische Anlassmodule. Mechanische Schalter. Bürstenhalter, elektronische Regler, Diodenbrücken, verschiedene Ersatzteile für Lichtmaschinen. Magnetschalter, Zündverteilerdeckel, Ersatzteile für Anlasser. Sicherungshalter, Batterietrennschalter, Stoßdämpfer für Positions- und Schlussleuchten, Zubehör für elektrische Anlagen in Fahrzeugen.

MEMBER'S S.p.A. a été fondé en 1965 et est présente depuis plus de 30 ans dans le secteur des **pièces de rechange** et des **composants** pour véhicules automobiles produisant des articles en **1er Équipement** et pour le marché des **Pièces de rechange**. L'établissement couvre une superficie de 10.000 m², sur un total de 40.000 m², comprenant les ateliers de production (ateliers de tourneur, de découpage et d'assemblage), les bureaux de réalisation et les laboratoires d'expérimentation et de contrôle en mesure de satisfaire les exigences particulières imposées par les Constructeurs de véhicules. MEMBER'S S.p.A. a non seulement obtenu la certification **UNI EN ISO 9001 en 1994**, les certifications **ISO TS 16949 en 2003**, **ATEX en 2004** et le certificat comme **de système de gestion environnemental**, mais a aussi été reconnue comme **Fournisseur agréé** des plus importants constructeurs au niveau mondial (VOLVO-RENAULT V.I., FIAT-IVECO, HALDEX, LUCAS, M.A.N., VALEO).

Grâce à la combinaison optimale de tous ces facteurs et à une efficace et rationnelle organisation commerciale, MEMBER'S S.p.A. distribue ses produits dans le monde entier se distinguant et s'imposant pour son efficacité, son innovation, sa qualité et sa fiabilité.

Notre production

Prises et fiches 12 V. et 24 V., cordons électriques et câblages variés pour remorques industrielles, agricoles, chariots et caravanes. **Prises-fiches "ABS"**. Prise-fiche 13 pôles 12 V. Prise-fiche 15 pôles 24 V. **Télérupteurs généraux de courant, électriques et électroniques ADR pour transport de marchandises dangereuses**. Modules d'allumage électronique. Interrupteurs mécaniques. Porte-balais, régulateurs électroniques, ponts diodes, pièces de rechange variées pour alternateurs. Solenoids, calottes, pièces de rechange variées pour démarreurs. Porte-fusibles volants, coupe-batterie, amortisseurs pour feux, articles complémentaires pour l'installation électrique des véhicules automobiles.

Il significato dei simboli riportati sui prodotti è illustrato in fondo al catalogo.

The key to symbols used to present the products are explained at the end of the catalogue .
 Die Zeichenerklärung ist in der Endseite des Katalogs abgebildet.
 Le sens des symboles des produits est illustré dans la page finale du catalogue .



Indice

Index • Inhaltsverzeichnis • Table des matieres

1	PRESE & SPINE	12V 5/7 POLI	6
	5/7 PINS SOCKETS & PLUGS 12V • 5/7-POLIGE STECKDOSEN & STECKER 12V • PRISES & FICHES 12V 5/7 BROCHES		
2	PRESE & SPINE	12V 13 POLI	20
	13 PINS SOCKETS & PLUGS 12V • 13-POLIGE STECKDOSEN & STECKER 12V • PRISES & FICHES 12V 13 BROCHES		
3	PRESE & SPINE	24V 7 POLI	30
	7 PINS SOCKETS & PLUGS 24V • 7-POLIGE STECKDOSEN & STECKER 24V • PRISES & FICHES 24V 7 BROCHES		
4	SPIRALI	12/24V 7 POLI	44
	7 PINS COILS 12/24V • 7-POLIGE SPIRALKABEL 12/24V • CORDONS ÉLECTRIQUES 12/24V 7 BROCHES		
5	PRESE & SPINE	24V 15 POLI	56
	15 PINS SOCKETS & PLUGS 24V • 15-POLIGE STECKDOSEN & STECKER 24V • PRISES & FICHES 24V 15 BROCHES		
6	SPIRALI E CABLAGGI	24V 15 POLI	68
	15 PINS COILS AND WIRING 24V • 15-POLIGE SPIRALKABEL UND VERBINDUNGSKABEL 24V • CORDONS ET CABLAGES 24V 15 BROCHES		
7	PRESE & SPINE	ABS/EBS 12/24 V	74
	SOCKETS & PLUGS ABS/EBS 12/24V • STECKDOSEN & STECKER ABS/EBS 12/24V • PRISES & FICHES ABS/EBS 12/24V		
8	SPIRALI E CABLAGGI	ABS/EBS 12/24 V	90
	SPIRAL COILS AND WIRING ABS/EBS 12/24V • SPIRALKABEL UND VERBINDUNGSKABEL ABS/EBS 12/24V • CORDONS ET CABLAGES ABS/EBS 12/24V		
9	PRESE & SPINE	2/3 POLI	100
	2/3 PINS SOCKETS & PLUGS • 2/3-POLIGE STECKDOSEN & STECKER • PRISES & FICHES 2/3 BROCHES		



ISO 1724 / ISO 3732

1

PRESE E SPINE 12V 7 POLI

**7 PINS SOCKETS & PLUGS 12V
7-POLIGE STECKDOSEN & STECKER 12V
PRISES & FICHES 12V 7 BROCHES**



PRESE E SPINE 12V 7 POLI ISO 1724 / ISO 3732

Applicazioni: questi connettori sono utilizzati per il collegamento elettrico tra un veicolo trainante ed un rimorchio, carrello o caravan, con impianto elettrico a 12V.

Il sistema comprende una versione N (NORMALE), realizzata secondo la normativa ISO 1724, generalmente impiegata per applicazioni standard. La versione S (SUPPLEMENTARE), realizzata secondo la normativa ISO 3732 è impiegata per ottenere collegamenti aggiuntivi. Quest'ultima si distingue per il colore BIANCO e per la diversa disposizione dei contatti che impedisce l'errato collegamento con la versione N.

La MEMBER'S fornisce questi connettori sia con corpo in materiale plastico che in alluminio, con contatti in ottone oppure in ottone nichelato, attacchi posteriori a vite o faston (lamellari) da 6,3mm. La versione con contatti a vite è destinata principalmente al mercato del ricambio (after-market) mentre la versione con contatti faston (lamellari) è preferita dai costruttori per produzione di cablaggi in serie, grazie alla rapidità del collegamento.

La spina con corpo in plastica esiste anche in versione con chiusura a scatto (Spina a LIBRO) che elimina l'operazione di avvitamento dei due semigusci. È di rapido assemblaggio e perciò particolarmente indicata per produzione di cablaggi in serie.

La gamma delle prese comprende anche i seguenti modelli speciali:

- prese dotate di un interruttore meccanico, azionato dall'inserimento della spina, per la commutazione dell'accensione del faro retronebbia dalla vettura a quello del rimorchio o caravan.
- prese con 16 contatti posteriori faston (5 doppi e 2 tripli) per sdoppiare l'impianto elettrico del rimorchio, evitando l'impiego di scatole di derivazione.



7 PINS SOCKETS & PLUGS 12V ISO 1724 / ISO 3732

Use: these connectors are used for electrical connections between a vehicle and a trailer or caravan, with 12 V electrical system.

The range consists of a N (Normal) version complying to ISO 1724, which is generally used for standard applications, and a S (Supplementary) version complying to ISO 3732 to be used for additional connections. The latter can easily be recognized by its WHITE colouring and by the different order of the contacts, thus preventing an incorrect connection to the N version.

MEMBER'S supplies these connectors both in plastic and aluminium, with brass or nickel-plated brass contacts, and 6,3 mm rear screw or flat terminals. The version with screw-on contacts is mainly intended for the replacement market (after-market); thanks to its fast connection; the flat terminals version is generally preferred by harness manufacturers.

The plug with plastic body exists also in a version with fast clip-lock (clip plug) which eliminates the screwing together of the two halves. It can be quickly assembled and is therefore particularly suitable for mass production of harnesses.

Included in the range of sockets are also the following special versions:

- sockets with a mechanical switch, set off by fitting in the plug, for the switching over of the rear fog light of the vehicle to the trailer or caravan.*
- sockets with 16 rear flat terminals (5 double and 2 triple) to double electrical system on the trailer, avoiding the use of junction boxes.*



7-POLIGE STECKDOSEN & STECKER 12V ISO 1724 / ISO 3732

Anwendung: diese Steckverbindungen sind für Anschlüsse zwischen einem Zugfahrzeug und einem Anhänger oder Caravan mit 12 V Schaltung bestimmt.

Verfügbar sind eine im allgemeinen für Standardanschlüsse verwendete N (Normal) Ausführung gemäß ISO 1724, sowie eine S (Supplementary) Ausführung gemäß ISO 3732 für zusätzliche Anschlüsse. Letztere unterscheidet sich durch ihre WEISSE Farbe sowie durch die unterschiedliche Anordnung der Kontakte, um Irrtümer beim Verbinden mit der N Ausführung zu vermeiden.

MEMBER'S liefert diese Steckverbindungen mit Gehäuse aus Kunststoff und Aluminium; Kontakte aus Messing oder vernickeltem Messing und hinteren 6,3 mm Schraub- oder Flachsteckanschlüssen. Die Ausführung mit Schraubanschlüssen richtet sich hauptsächlich an den Ersatzteilmarkt während die Flachsteckausführung, dank der schnell auszuführenden Verbindung, von der Automobilindustrie für die serienmäßige Kabelproduktion vorgezogen wird.

Der Stecker aus Kunststoff ist auch in der Ausführung mit Schnappverschluss (Faltstecker) lieferbar, wobei das Anschrauben der zwei Hälften entfällt. Dank der schnellen Montage ist dieser Typ besonders für die serienmäßige Kabelproduktion geeignet.

Weiterhin verfügbar in der Produktpalette der Steckdosen sind folgende Spezialausführungen:

- Steckdosen mit mechanischem Ausschaltmechanismus, ausgelöst durch das Einsetzen des Steckers, zum Umschalten der Nebelschlussleuchte des Zugfahrzeugs zum Anhänger oder Caravan.*
- Steckdosen mit 16 hinteren Flachsteckanschlüssen (5 doppelte und 2 dreifache) um die elektrische Anlage des Anhängers ohne weitere Verteilerkasten auszuführen.*



PRISES & FICHES 12V 7 BROCHES ISO 1724 / ISO 3732

Applications: ces connecteurs sont utilisés pour la connexion électrique entre un véhicule tracteur et une remorque, un chariot ou une caravane avec installation électrique à 12 V.

Le système comprend une version N (NORMALE), réalisée conformément à la normative ISO 1724, généralement employée pour des applications standard. La version S (SUPPLÉMENTAIRE), réalisée conformément à la normative ISO 3732 est employée pour obtenir des connexions supplémentaires. Cette version se distingue par sa couleur BLANCHE et par une disposition différente des contacts qui empêche la mauvaise connexion avec la version N.

MEMBER'S fournit ces connecteurs aussi bien avec un corps en plastique qu'en aluminium, avec des contacts en laiton ou en laiton nickelé, attaches arrière à serre-fils ou cosses plates de 6,3 mm. La version avec contacts à serre-fils est principalement destinée au marché des pièces de rechange (after-market) tandis que la version avec cosses plates est préférée par les constructeurs pour la production de câblages en série, grâce à la rapidité de la connexion.

La fiche avec corps en plastique existe aussi en version avec fermeture rapide à dé clic (fiche en forme de LIVRE) qui élimine l'opération de vissage des deux demi-coques. Elle est à assemblage rapide et pour cela particulièrement recommandée pour la production de câblages en série.

La gamme des prises comprend également les modèles spéciaux:

- prises dotées d'un interrupteur mécanique, actionné par l'introduction de la fiche, pour la commutation de l'allumage du feu arrière anti-brouillard de la voiture à la remorque ou la caravane;*
- prises avec 16 contacts arrière à cosses plates (5 doubles et 2 triples) pour dédoubler l'installation électrique de la remorque, évitant l'utilisation de la boîte de dérivation.*

SCHEMA DI CONNESSIONE
CONTACTS ALLOCATION
KONTAKTBELEGUNG
AFFECTATION DES CONTACTS

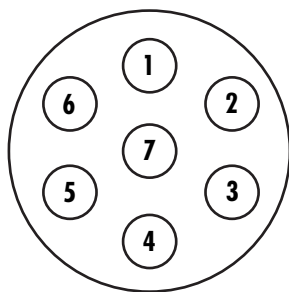

Connettori 7 poli 12V tipo N Norma ISO 1724 7 pins Connectors type N ISO 1724
7-polige Verbindungen 12V Typ N gemäß Norm ISO 1724 Connecteurs 7 broches 12V type N Norme ISO 1724

Contatto n Contact no Kontakt Nr. Contact n	Funzione Function Funktion Fonction	Sezione Cavo Cable Diameter Kabeldurchmesser Couleur Câble	Colore cavo Colour Kabelfarbe Couleur câble
1	Indicatori di direzione SINISTRA Left indicators Fahrtrichtungsanzeiger LINKS Indicateurs de direction GAUCHE	1,5 mm ²	Giallo Yellow Gelb Jaune
2	Luce retro-nebbia Rear fog light Hintere Nebelschlussleuchte Lumière feu de brouillard arrière	1,5 mm ²	Blu Blue Blau Bleu
3	Massa Earth connection Masse Masse	2,5 mm ²	Bianco White Weiss Blanc
4	Indicatori di direzione DESTRA Right indicators Fahrtrichtungsanzeiger RECHTS Indicateurs de direction DROIT	1,5 mm ²	Verde Green Grün Vert
5	Luce di posizione , luci di ingombro , illuminazione targa DESTRA Side lights, side markers, numberplate light RIGHT Schlussleuchte, Umriß-Begrenzungsleuchte, Kennzeichenleuchte RECHTS Feux de positions, feux d'encombrement, éclairage plaque DROITE	1,5 mm ²	Marrone Brown Braun Marron
6	Luci di stop Stop lights Bremslichter Feux stop	1,5 mm ²	Rosso Red Rot Rouge
7	Luce di posizione , luci di ingombro , illuminazione targa SINISTRA Side lights, side markers, numberplate light LEFT Schlussleuchte, Umriß-Begrenzungsleuchte, Kennzeichenleuchte LINKS Feux de positions, feux d'encombrement, éclairage plaque GAUCHE	1,5 mm ²	Nero Black Schwarz Noir

Connettori 7 poli 12V tipo S Norma ISO 3732 7pins connectors 12V type S ISO 3732
7 polige Verbindungen 12V Typ S gemäß Norm ISO 3732 Connecteurs 7 broches 12V type S Norme ISO 3732

















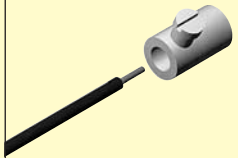

1	Luci di retromarcia Reversing lights Rückfahrleuchte Feux de marche arrière	1,5 mm ²	Giallo Yellow Gelb Jaune
2	Segnalazione collegamento rimorchio Signal connection trailer Kontrollleuchte Anschluss Anhänger Signalisation raccordement remorque		
3	Massa di ritorno per contatto n4 Return earth connection for contact 4 Rückkehrmasse für Kontakt Nr. 4 Masse de retour pour contact n4	2,5 mm ²	Bianco White Weiss Blanc
4	Positivo di alimentazione diretto da batteria Positive direct current feed from battery Pos. Stromspeisung direkt von Batterie Positif d'alimentation directe de batterie	2,5 mm ²	Verde Green Grün Vert
5	Nessuna applicazione No allocation Kein Anschluss Aucune application	1,5 mm ²	Marrone Brown Braun Marron
6	Positivo di alimentazione sotto chiave avviamento Positive ignition key Pos. Stromspeisung mit Zündschlüssel Positif d'alimentation sous clefs de mise en route	2,5 mm ²	Rosso Red Rot Rouge
7	Massa di ritorno per contatto n6 Return earth connection for contact no.6 Rückkehrmasse Kontakt Nr. 6 Masse de retour pour contact n6	2,5 mm ²	Nero Black Schwarz Noir

	Materiale corpo Material Corps Material Matériel	Norma Norm Norm Norme	Tipo contatti Type of contact Anschluss Type contacts	Materiale contatti Pins made of Material Kontakt Matériel contacts	Articolo Item no. Artikel-Nr. Article	Confezionamento Packaging Verpackung Emballage
	AL	DIN 7257?  N		0	004315.00	 20
	AL	ISO 1724  N		0	004317.00	 20
 <p data-bbox="279 996 494 1097"> <i>Con stacco retronebbia</i> <i>With Rear fog light Cut-Off</i> <i>Mit Nebelschlussleuchtenabschaltung</i> <i>Avec commutation feu arrière antibrouillard</i> </p>	AL	ISO 1724  N		0	004317.90	 200
	AL	ISO 1724  N		0	004317.99	 200
	AL	ISO 3732  S		0	004311.00	 20
					004311.90	 200
					004311.99	 200

 Le prese e le spine 7 poli 12V vengono fornite anche con contatti in ottone nichelato

 The 7 pins 12V plugs and sockets are also supplied with nickel plated brass contacts









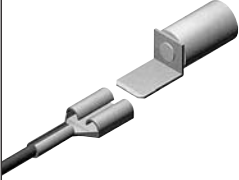

SPINE 12V 5/7 POLI 5/7 PINS PLUGS 12V 5/7-POLIGE STECKER 12V FICHES 12V 5/7 BROCHES

	Materiale corpo Material Corps Material Matériel	Norma Norm Norm Norme	Tipo contatti Type of contact Anschluss Type contacts	Materiale contatti Pins made of Material Kontakt Matériel contacts	Articolo Item no. Artikel-Nr. Article	Confezionamento Packaging Verpackung Emballage
	AL	DIN 7257?  N		0	005165.00	 20
	AL	ISO 1724  N		0	005167.00	 20
	AL	ISO 3732  S		0	005169.00	 20
					005167.90	 200
					005167.99	 200 
					005169.90	 200
					005169.99	 200 

 Die 7 poligen 12V stecker und steckdosen sind auch mit kontakten aus vernickeltem messing erhältlich

 Les prises et fiches 7 broches 12V sont fournies aussi avec les contacts en laiton nickelé

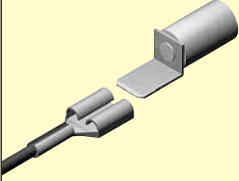
PRESE 12V 5/7 POLI 5/7 PINS SOCKETS 12V 5/7-POLIGE STECKDOSEN 12V PRISES 12V 5/7 BROCHES



	Materiale corpo Material Corps Material Matériel	Norma Norm Norm Norme	Tipo contatti Type of contact Anschluss Type contacts	Materiale contatti Pins made of Material Kontakt Matériel contacts	Articolo Item no. Artikel-Nr. Article	Confezionamento Packaging Verpackung Emballage
  <p data-bbox="331 712 496 799"><i>16 attacchi faston With 16 flat Terminals Mit 16 Flachsteckanschlüssen 16 cosses plates</i></p>	AL	ISO 1724  N		0	004337.00 004337.90 004337.99 004357.00	   
	AL	ISO 3732  S		0	004331.00	

 Le prese e le spine 7 poli 12V vengono fornite anche con contatti in ottone nichelato

 The 7 pins 12V plugs and sockets are also supplied with nickel plated brass contacts

SPINE 12V 5/7 POLI 5/7 PINS PLUGS 12V 5/7-POLIGE STECKER 12V FICHES 12V 5/7 BROCHES

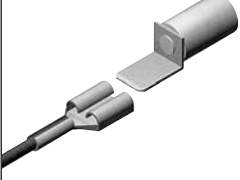

Materiale corpo Material Corps Material Matériel	Norma Norm Norm Norme	Tipo contatti Type of contact Anschluss Type contacts	Materiale contatti Pins made of Material Kontakt Matériel contacts	Articolo Item no. Artikel-Nr. Article	Confezionamento Packaging Verpackung Emballage
	ISO 1724  N			005177. 00	
				005177. 90	
				005177. 99	

 Die 7 poligen 12V stecker und steckdosen sind auch mit kontakten aus vernickeltem messing erhältlich

 Les prises et fiches 7 broches 12V sont fournies aussi avec les contacts en laiton nickelé



























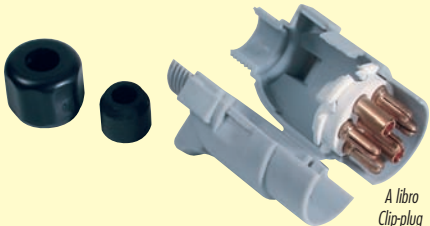

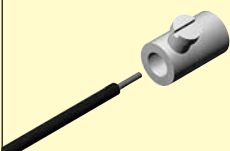
PRESE 12V 7 POLI 7 PINS SOCKETS 12V 7-POLIGE STECKDOSEN 12V PRISES 12V 7 BROCHES

	Materiale corpo Material Corps Material Matériel	Norma Norm Norm Norme	Tipo contatti Type of contact Anschluss Type contacts	Materiale contatti Pins made of Material Kontakt Matériel contacts	Articolo Item no. Artikel-Nr. Article	Confezionamento Packaging Verpackung Emballage
	PL	ISO 1724  N		0	004017.00	
					004017.90	
					004017.99	
					004217.00	
					004217.90	
					004217.99	
 <i>Bassa With lower Body Niedrigere Bauhöhe Basse</i>					004219.00	
					004219.90	
 <i>Con stacco retronebbia With Rear fog light Cut-Off Mit Nebelschlussleuchtenabschaltung Avec commutation feu arrière antibrouillard</i>					004273.00	
					004273.90	
					004273.99	
					PL	ISO 3732  S
	004011.90					
	004011.99					
	004211.00					
	004211.90					
	004211.99					

 Le prese e le spine 7 poli 12V vengono fornite anche con contatti in ottone nichelato

 The 7 pins 12V plugs and sockets are also supplied with nickel plated brass contacts

SPINE 12V 7 POLI 7 PINS PLUGS 12V 7-POLIGE STECKER 12V FICHES 12V 7 BROCHES

	Materiale corpo Material Corps Material Matériel	Norma Norm Norm Norme	Tipo contatti Type of contact Anschluss Type contacts	Materiale contatti Pins made of Material Kontakt Matériel contacts	Articolo Item no. Artikel-Nr. Article	Confezionamento Packaging Verpackung Emballage
					005197.00	
					005197.90	
					005197.99	 
 <p data-bbox="432 1099 496 1189">A libro Clip-plug Faltstecker À déclip</p>		ISO 1724  N			005117.00	
					005117.90	
					005117.99	 
					006069.00	
  <p data-bbox="432 1917 496 2007">A libro Clip-plug Faltstecker À déclip</p>		ISO 3732  S			005190.00	
					005190.90	
					005190.99	 
					005119.00	
					005119.90	
					005119.99	 

 Die 7 poligen 12V stecker und steckdosen sind auch mit kontakten aus vernickeltem messing erhältlich

 Les prises et fiches 7 broches 12V sont fournies aussi avec les contacts en laiton nickelé











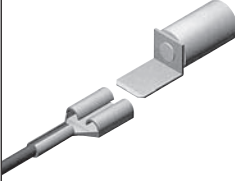

PRESE 12V 7 POLI 7 PINS SOCKETS 12V 7-POLIGE STECKDOSEN 12V PRISES 12V 7 BROCHES





	Materiale corpo Material Corps Material Matériel	Norma Norm Norm Norme	Tipo contatti Type of contact Anschluss Type contacts	Materiale contatti Pins made of Material Kontakt Matériel contacts	Articolo Item no. Artikel-Nr. Article	Confezionamento Packaging Verpackung Emballage
					004037.00 	
		ISO 1724  N			004037.90 	
 <i>16 attacchi faston With 16 flat Terminals Mit 16 Flachsteckanschlüssen 16 cosses plates</i>					004037.99  	
		ISO 3732  S			004031.00 	
					004031.90 	
					004031.99  	
					004231.00 	
					004231.90 	
					004231.99  	

 Le prese e le spine 7 poli 12V vengono fornite anche con contatti in ottone nichelato

 The 7 pins 12V plugs and sockets are also supplied with nickel plated brass contacts

SPINE 12V 7 POLI 7 PINS PLUGS 12V 7-POLIGE STECKER 12V FICHES 12V 7 BROCHES

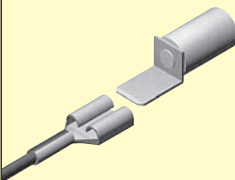
	Materiale corpo Material Corps Material Matériel	Norma Norm Norm Norme	Tipo contatti Type of contact Anschluss Type contacts	Materiale contatti Pins made of Material Kontakt Matériel contacts	Articolo Item no. Artikel-Nr. Article	Confezionamento Packaging Verpackung Emballage
	PL	ISO 1724  N		0	005192.00	
					005127.00	
					005127.90	
					005127.99	 
	<i>Gommino passacavo per spine a libro 2 fori Rubber grommet with 2 cable outlets for clip plugs 2-fach Gummihaltertülle je Bohrloch für Faltstecker Chaumard en caoutchouc 2 trous pour fiche à déclit Ø6,5mm</i>				006069.00	

	PL	ISO 3732  S		0	005191.00	
--	----	---	---	---	-----------	---

CABLAGGI 12V 7 POLI 7 POLE WIRING HARNESSES 12V 7-POLIGE ELEKTROSÄTZE 12V CABLAGES ÉLECTRIQUES 7 BROCHES 12V

	Descrizione Description Beschreibung Description	Articolo Item no. Artikel-Nr. Article	Confezionamento Packaging Verpackung Emballage
	<i>Kit elettrico 12V 7 poli - ISO 1724 - DIN 72577 e cablaggio universale lunghezza mm. 1.420 Electrical kit equipped with 12V 7 pin socket-ISO 1724 DIN 72577 and universal wiring harness, L. 1.420 mm Elektrosatz mit 7-poliger Steckdose 12V nach ISO 1724 DIN 72577 und Universalkabel, L. 1.420 mm Kit électrique avec prise 7 broches 12V ISO 1724 DIN 72577 et câblage universel, L. 1.420 mm</i>	002500.00	
	<i>Kit elettrico 12V 7 poli - ISO 1724 - DIN 72577 e cablaggio universale lunghezza mm. 1.700 Electrical kit equipped with 12V 7 pin socket-ISO 1724 DIN 72577 and universal wiring harness, L. 1.700 mm Elektrosatz mit 7-poliger Steckdose 12V nach ISO 1724 DIN 72577 und Universalkabel, L. 1.700 mm Kit électrique avec prise 7 broches 12V ISO 1724 DIN 72577 et câblage universel, L. 1.700 mm</i>	002501.00	

 Die 7 poligen 12V stecker und steckdosen sind auch mit kontakten aus vernickeltem messing erhältlich

 Les prises et fiches 7 broches 12V sont fournies aussi avec les contacts en laiton nickelé

PRESE PARTICOLARI SPECIAL SOCKETS SPEZIALSTECKDOSEN PRISES PARTICULIERES

	Materiale corpo Material Corps Material Matériel	Norma Norm Norm Norme	Tipo contatti Type of contact Anschluss Type contacts	Materiale contatti Pins made of Material Kontakt Matériel contacts	Articolo Item no. Artikel-Nr. Article	Confezionamento Packaging Verpackung Emballage
 <p>+ Presa 2 Poli + 2P Socket Mit zusätzlicher Einbaudose 2P + Prise 2 broches</p>		ISO 1724 ISO 4165  N			005248.00	
 <p>Volante Coupling Socket Kupplungs-Steckdose Volante</p>		ISO 1724  N			005497.00 005497.99	 
 <p>Volante Coupling Socket Kupplungs-Steckdose Volante</p>		ISO 3732  S			005498.00 005498.99	 
 <p>Preso stagna 220V 16A Cee17 Waterproof Socket 220V 16A Cee17 Steckdose wasserdicht 220V 16A Cee17 Prise étanche 220V 16A Cee17</p>					005991.00	

 Le prese e le spine 7 poli 12V vengono fornite anche con contatti in ottone nichelato

 The 7 pins 12V plugs and sockets are also supplied with nickel plated brass contacts

 Die 7 poligen 12V stecker und steckdosen sind auch mit kontakten aus vernickeltem messing erhältlich

 Les prises et fiches 7 broches 12V sont fournies aussi avec les contacts en laiton nickelé

	Descrizione Description Beschreibung Description	Articolo Item no. Artikel-Nr. Article	Confezionamento Packaging Verpackung Emballage
	Cappuccio posteriore spine 12V 7 poli Rear protecting cap for 7 pin 12V Plug Hintere Schutzkappe für Stecker 7-polig 12V Joint arrière Fiches 12V 7 broches	006002.00	
	Guarnizione posteriore prese 12V 7 poli a vite Rear rubber gasket for 7 pin 12V Socket with screw terminals Hintere Gummidichtung für Steckdose 12V 7-polig mit Schraubanschlüssen Joint arrière prises 12V 7 broches á vis	006004.00	
	Guarnizione posteriore prese 12V 7 poli faston Rear protecting cap for 7 pin 12V Socket with flat Terminals Hintere Gummidichtung für Steckdose 7-polig 12V Mit Flachsteckanschlüssen Joint arrière prises 12V 7 broches cosses plates	006005.00	
	Blocchetto con cavetti prese 12V 7 poli faston Wired flat terminal coupling for 7 pin 12V Socket Flachsteckkupplung mit Kabelsatz komplett montiert für Steckdose 7-polig 12V Connecteur avec câbles prises 12V 7 broches cosses plates	006006.00	
	Blocchetto prese 12V 7 poli faston Flat Terminal coupling for 7 pin 12V Socket Flachsteckkupplung ohne Verbindungskabeln für Steckdose 7-polig 12V Connecteur prises 12V 7 broches cosses plates	006032.00	
	Guarnizione posteriore prese 12V 7 poli a vite Rear Rubber Gasket for 7 pin 12V Socket with screw Terminals Hintere Gummidichtung für Steckdose 7-polig 12V mit Schraubanschlüssen Joint arrière prises 12V 7 broches á vis	006057.00	
		006057.90	
		006057.99	
	Guarnizione posteriore prese 12V 7 poli faston Rear Rubber Gasket for 7 pin 12V Socket with flat Terminals Hintere Gummidichtung für Steckdose 7-polig 12V Mit Flachsteckanschlüssen Joint arrière prises 12V 7 broches cosses plates	006058.00	
		006058.90	
		006058.99	
 NEW	Guarnizione posteriore flessibile per prese 12V 7 poli, uscita cavo diritta Flexible rear rubber gasket for 7 pin 12V socket, with straight cable outlet Biegeweiche hintere Gummidichtung für Steckdose 7-polig 12V, mit geradem Kabelabgang Joint arrière flexible prises 12V 7 broches, avec sortie du cable droite	006066.00	
 NEW	Guarnizione posteriore prese 12V 7 poli, uscita cavo a 90° Rear rubber gasket for 7 pin 12V socket, with 90° cable outlet Hintere Gummidichtung für Steckdose 7-polig 12V, mit 90° Kabelabgang Joint arrière prises 12V 7 broches, avec sortie du cable a 90°	006067.00	



ISO 11446 (DIN 72570)

2

PRESE & SPINE 12V 13 POLI

**13 PINS SOCKETS & PLUGS 12V
13-POLIGE STECKDOSEN & STECKER 12V
PRISES & FICHES 12V 13 BROCHES**



PRESE & SPINE 12V 13 POLI ISO 11446 (DIN 72570)

Applicazioni: questi connettori sono utilizzati per il collegamento elettrico tra un veicolo trainante ed un rimorchio, carrello o caravan, con impianto elettrico a 12V.

Questo nuovo sistema raggruppa in un unico connettore tutti i collegamenti previsti nel vecchio sistema a 12V 7 poli tipo N e tipo S. È caratterizzato da una maggiore robustezza meccanica, da una maggiore impermeabilità all'acqua e garantisce un collegamento elettrico più affidabile e sicuro. La spina si collega alla presa con un sistema a baionetta anti-sfilamento. Contatti in Ottone nichelato, attacchi posteriori a vite o, per alcuni modelli, da crimpare.

Le spine sono disponibili sia in versione "tradizionale" sia in una nuova versione, brevettata, che consente un assemblaggio più rapido pur rispettando pienamente le caratteristiche dettate dalla Norma. Questa nuova versione è stata dotata di un attrezzo per il montaggio del porta contatti che funge anche da presa di parcheggio.

La presa esiste anche in versione dotata di un dispositivo azionato dall'inserimento della spina, meccanico a leva o mediante micro interruttore, per la commutazione dell'accensione del faro retronebbia dalla vettura a quello del rimorchio o caravan.

Sono disponibili adattatori di vario tipo per collegare il vecchio sistema a 7 poli N ed S con il nuovo sistema a 13 poli e viceversa.



13 PINS SOCKETS & PLUGS 12V ISO 11446 (DIN 72570)

Use: these connectors are used for electrical connections between a vehicle and a trailer or caravan with 12V electrical system.

This new system provides in a single connector for all the connections required in the old 7 p 12 V system type N and S. Advantages are greater mechanical resistance, higher watertightness and a more reliable and safe electrical connection. The plug connects to the socket with a bayonet twist system to avoid accidental disconnection. Nickelplated brass contacts, rear screw terminals or, for some versions, crimp type.

The plugs are available both in the "traditional" version and in a new patented version, allowing faster assembly yet complying to the requirements of the norm. The new version has been equipped with a tool for fitting the insert which can also be used as a parking protection.

The socket is also available in a version with a mechanism - lever or microswitch - triggered off by fitting in the plug, for the commutation of the rear fog light from the car/vehicle to the trailer or caravan.

Various types of adaptors are available to connect the old 7p N and S system to the new 13p system and vice versa.



13-POLIGE STECKDOSEN & STECKER 12V ISO 11446 (DIN 72570)

Anwendung: diese Steckverbindungen sind für den Anschluss zwischen einem Zugfahrzeug und einem Anhänger oder Caravan mit 12V Schaltung bestimmt.

Mit dem neuen System können alle im herkömmlichen 12V 7-Pole System N und S vorgesehenen Anschlüsse in einem ausgeführt werden. Dank der größeren Widerstandsfähigkeit und Wasserdichte ist der Anschluss zuverlässiger und sicherer. Der Stecker ist mit einer Bayonettverriegelung mit der Steckdose verbunden. Kontakte aus vernickeltem Messing, hintere Schraubanschlüsse oder, bei einigen Modellen, Crimpanschlüsse.

Die Stecker können in der herkömmlichen und auch in einer neuen patentierten Ausführung geliefert werden. Letztere erlaubt eine schnellere Montage. Das neue Modell wurde zur Montage des Kontakthalters mit einem Montage- und Demontagewerkzeug versehen, das auch als Parksteckdose/Parkschutz verwendet werden kann.

Die Steckdose ist auch in einer Ausführung lieferbar, wobei das Einsetzen des Steckers - mittels Schalthebel oder Microswitch - einen Mechanismus zum Umschalten der Nebelschlussleuchte vom Zugfahrzeug zum Anhänger oder Caravan auslöst.

Weiterhin lieferbar sind verschiedene Adaptertypen um das herkömmliche 7-polige N und S System mit dem neuen 13-poligen System zu verbinden und umgekehrt.



PRISES & FICHES 12V 13 BROCHES ISO 11446 (DIN 72570)

Applications: ces connecteurs sont utilisés pour la connexion électrique entre un véhicule tracteur et une remorque, un chariot ou une caravane avec installation électrique à 12 V.

Ce nouveau système regroupe dans un seul connecteur toutes les connexions prévues dans l'ancien système à 12 V 7 pôles type N et type S. Il se caractérise par une plus grande robustesse mécanique, par une plus grande étanchéité à l'eau et garantit une connexion électrique plus fiable et sûre. La fiche se raccorde à la prise avec un système à baïonnette à encliquetage. Contacts en laiton nickelé, attaches arrière à serre-fils ou pour certains modèles, à sertir.

Les fiches sont disponibles aussi bien en version "traditionnelle" qu'en nouvelle version, brevetée, qui permet un assemblage plus rapide tout en respectant pleinement les caractéristiques imposées par la Norme. Cette nouvelle version a été dotée d'un outil pour le montage des portes-contacts qui serve également de prise de parking.

La prise existe également dans une version dotée d'un dispositif actionné par l'introduction de la fiche, mécanique à levier ou par micro-interrupteur, pour la commutation de l'allumage du feu arrière anti-brouillard de la voiture à celui de la remorque ou de la caravane.

Des adaptateurs de différents types pour raccorder l'ancien système 7 broches N et S avec le nouveau système 13 broches et vice-versa sont disponibles.



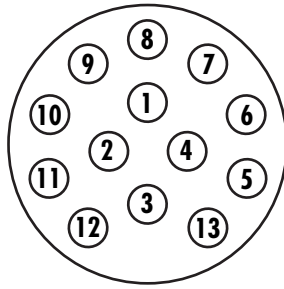











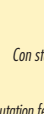
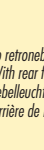



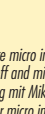









SCHEMA DI CONNESSIONE
CONTACTS ALLOCATION
KONTAKTBELEGUNG
AFFECTATION DES CONTACTS

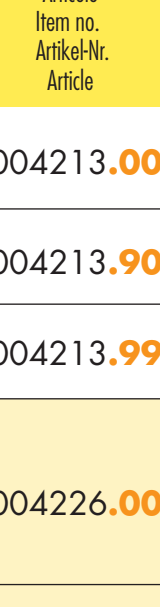

Connettori 13 poli 12V Norma ISO 11446 13 pins connectors 12V ISO 11446
13-polige 12V Verbindungen gemäß ISO 11446 Connecteurs 13 broches 12V Norme ISO 11446

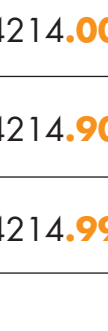
Contacto n Contact no Kontakt Nr. Contact n	Funzione Funktion Fonction	Sezione Cavo Cable Diameter Kabeldurchmesser Couleur Câble	Colore cavo Colour Kabelfarbe Couleur câble
1	Indicatori di direzione SINISTRA Indicators LEFT Fahrtrichtungsanzeiger LINKS Indicateurs de direction GAUCHE	1,5 mm ²	Giallo Yellow Gelb Jaune
2	Luce retro-nebbia Rear fog light Nebelschlussleuchte Lumière feu de brouillard arrière	1,5 mm ²	Blu Blue Blau Bleu
3	Massa per contatti da n1 a n8 Earth for contacts 1 to 8 Masse für Kontakte 1 bis 8 Masse pour contact du n1 au n8	2,5 mm ²	Bianco White Weiss Blanc
4	Indicatori di direzione DESTRA Indicators RIGHT Fahrtrichtungsanzeiger RECHTS Indicateurs de direction DROIT	1,5 mm ²	Verde Green Grün Vert
5	Luce di posizione , luci di ingombro , illuminazione targa DESTRA Side lights, end outmarker lights, numberplate light RIGHT Schlussleuchte, Umriss-Begrenzungsleuchte, Kennzeichenleuchte RECHTS Feux de positions, feux d'encombrement, éclairage plaque DROITE	1,5 mm ²	Marrone Brown Braun Marron
6	Luci di stop Brake lights Bremslichter Feux stop	1,5 mm ²	Rosso Red Rot Rouge
7	Luce di posizione , luci di ingombro , illuminazione targa SINISTRA Side lights, end outmarker lights, numberplate light LEFT Schlussleuchte, Umriss-Begrenzungsleuchte, Kennzeichenleuchte LINKS Feux de positions, feux d'encombrement, éclairage plaque GAUCHE	1,5 mm ²	Nero Black Schwarz Noir
8	Luci di retromarcia Reverse light Rückfahrleuchte Feux de marche arrière	1,5 mm ²	Rosa Pink Rosa Rose
9	Positivo di alimentazione diretto da batteria Positive direct from battery Pos. Stromspeisung direkt von Batterie Positif d'alimentation directe de batterie	2,5 mm ²	Arancio Orange Orange Orange
10	Positivo di alimentazione sotto chiave avviamento Positive ignition key on Pos. Stromspeisung mit Zündschlüssel Positif d'alimentation sous clefs de mise en route	2,5 mm ²	Grigio Grey Grau Gris
11	Massa di ritorno per contatto n10 Return earth contact no. 10 Rückkehrmasse für Kontakt Nr. 10 Masse de retour pour contact n10	2,5 mm ²	Bianco/NEro White/Black Weiss/Schwarz Blanc/Noir
12	Segnalazione collegamento rimorchio Signalling connection to trailer Kontrollleuchte Anschluss Anhänger Signalisation raccordement remorque		
13	Massa di ritorno per contatto n9 Return earth for contact no. 9 Rückkehrmasse /Retourmasse für Kontakt Nr. 9 Masse de retour pour contact n9	2,5 mm ²	Bianco/Rosso White/Red Weiss/Rot Blanc/Rouge

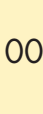
PRESE 12V 13 POLI 13 PINS SOCKETS 12V 13-POLIGE STECKDOSEN 12V PRISES 12V 13 BROCHES

	Norma Norm Norm Norme	Tipo contatti Type of contact Anschluss Type contacts	Materiale contatti Pins made of Material Kontakt Matériel contacts	Articolo Item no. Artikel-Nr. Article	Confezionamento Packaging Verpackung Emballage
	ISO 11446 DIN 72570 			004213.00 004213.90 004213.99	  
 <p data-bbox="670 324 726 705"> <i>Con stacco retronebbia meccanico With mechanical rear foglight cut-off Nebelleuchteabschaltung mit Mikroschalter Avec commutation feu arrière de brouillard mécanique</i> </p>	ISO 11446 DIN 72570 			004226.00 004226.90 004226.99	  
 <p data-bbox="885 380 941 705"> <i>Con stacco retronebbia con micro interruttore With rear foglight cut-off micro switch Nebelleuchteabschaltung mit Mikroschalter Avec commutation feu arrière de brouillard micro interrupteur</i> </p>	ISO 11446 DIN 72570 			004214.00 004214.90 004214.99	  
 <p data-bbox="1101 201 1125 705"> <i>Come sopra, con 2 microinterruttori - Same as above, with 2 micro switches Ditto, mit 2 Mikroschaltern - Comme ci-dessus, avec 2 micro interrupteurs</i> </p>				004214.62	
 <p data-bbox="1412 347 1468 705"> <i>Con stacco retronebbia mediante micro interruttore With rear foglight cut-off and micro switch Nebelleuchteabschaltung mit Mikroschalter Avec commutation feu arrière de brouillard par micro interrupteur</i> </p>	ISO 11446 DIN 72570 			004201.00 004201.90 004201.99	  

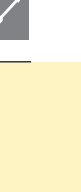
 Tutte le prese 13 poli vengono fornite complete di guarnizione.
 All the 13 pins sockets are complete with the rear gasket.
 Alle 13 poligen Steckdosen werden versehen mit Schutzkappe geliefert.
 Toutes les prises 13 broches sont fournies avec le joint arrière.

SPINE 12V 13 POLI 13 PINS PLUGS 12V 13-POLIGE STECKER 12V FICHES 12V 13 BROCHES

	Norma Norm Norm Norme	Tipo contatti Type of contact Anschluss Type contacts	Materiale contatti Pins made of Material Kontakt Matériel contacts	Articolo Item no. Artikel-Nr. Article	Confezionamento Packaging Verpackung Emballage
 <p>Con manicotto 1 foro per cavi Ø 8/15 mm With rubber grommet 1 hole for cables with Ø 8/15 mm Mit Gummi-Knickschutzhülle 1 öffnung für kabel mit durchmesser Ø 8/15 mm Avec manchon 1 trou pour câbles Ø 8/15 mm</p>	<p>ISO 11446 DIN 72570</p> 		<p>ON</p>	005112.00 	
				005112.90 	
				005112.99  	
 <p>(8 contatti) con manicotto con 2 fori per cavi Ø 6/7 mm (8 contacts) rubber cable guard with 2 holes for cables of Ø 6/7 mm (8 Kontakte) Knickschutzhülle mit 2 öffnungen für kabel mit durchmesser Ø 6/7 mm (8 contacts) avec manchon avec 2 trous pour câbles Ø 6/7 mm</p>	<p>ISO 11446 DIN 72570</p> 		<p>ON</p>	005111.00 	
				005111.90 	
				005111.99  	
				005111.60  	
 <p>(8 contatti) manicotto 1 foro per cavi Ø 8/15 mm (8 contacts) with rubber grommet 1 hole for cables with Ø 8/15 mm (8 Kontakte) mit Gummi-Knickschutzhülle 1 öffnung für kabel mit durchmesser Ø 8/15 mm (8 contacts) avec manchon 1 trou pour câbles Ø 8/15 mm</p>				005113.00 	
	<p>ISO 11446 DIN 72570</p> 		<p>ON</p>	005113.90 	
				005113.99  	
 <p>Con manicotto - With rubber grommet Mit Gummi-Knickschutzhülle - Avec manchon</p>	<p>ISO 11446 DIN 72570</p> 		<p>ON</p>	005110.00 	
				 <p>(8 contatti) manicotto con 2 fori (8 contacts) with rubber grommet with 2 cable outlets (8 Kontakte) mit Gummi-Knickschutzhülle mit 2 fach-kabelaustritt (8 contacts) avec manchon avec 2 trous</p>	<p>ISO 11446 DIN 72570</p> 

Articolo / Item no.  x1
 Artikel-Nr. / Article  x1
00

Articolo / Item no.  x100
 Artikel-Nr. / Article  x1
90





Articolo / Item no.  x100
 Artikel-Nr. / Article  x100
99

	Descrizione Description Beschreibung Description	Articolo Item no. Artikel-Nr. Article	Confezionamento Packaging Verpackung Emballage
	<p><i>Adattatore presa 13 poli + spina 7 poli 12V cavo 1m</i> <i>Adapter from 13-pin socket to 7-pin 12V plug, 1 m cable</i> <i>Adapter von Steckdose 13-polig 12V auf Stecker 7-polig 12V mit 1m Kabel</i> <i>Adaptateur prise 13 broches + fiche 7 broches 12V câble 1m</i></p>	<p>005551.00</p>	
	<p><i>Adattatore presa 13 poli + spina 7 poli 12V cavo 0,1m</i> <i>Adapter from 13-pin socket to 7-pin 12V plug, 0,1m cable</i> <i>Adapter von Steckdose 13-polig 12V auf Stecker 7-polig 12V mit 0,1m Wellrohr</i> <i>Adaptateur prise 13 broches + fiche 7 broches 12V câble 0,1m</i></p>	<p>005549.00</p>	
	<p><i>Micro adattatore spina 7 poli + presa 13 poli 12V con coperchio</i> <i>Micro adapter from 7-pin plug to 13-pin 12V socket with cover</i> <i>Mikroadapter von Stecker 7-polig 12V auf Steckdose 13-polig 12V mit Schutzkappes</i> <i>Adaptateur micro fiche 7 broches + prise 13 broches 12V avec couvercle</i></p>	<p>005604.00</p>	
	<p><i>Micro adattatore spina 7 poli + presa 13 poli 12V come 005604.00 e 005604.90 ma senza coperchio</i> <i>Micro adapter from 7-pin plug to 13-pin 12V socket like 005604.00 and 005604.90 but without cover</i> <i>Mikroadapter von Stecker 7-polig 12V auf Steckdose 13-polig 12V wie 005604.00 und 005604.90 aber ohne Schutzkappe</i> <i>Adaptateur micro fiche 7 broches + prise 13 broches 12V comme le 005604.00 et le 005604.90 mais sans le couvercle de protection</i></p>	<p>005603.00</p>	
		<p>005603.90</p>	





ADATTATORI 12V 13 POLI 13 PINS ADAPTERS 12V 13-POLIGE ADAPTER 12V ADAPTATEURS 12V 13 BROCHES

	Descrizione Description Beschreibung Description	Articolo Item no. Artikel-Nr. Article	Confezionamento Packaging Verpackung Emballage
	<p> <i>Micro adattatore spina 13 poli + presa 7 poli 12V</i> <i>Micro adapter from 13-pin plug to 7-pin 12V socket</i> <i>Mikroadapter von Stecker 13-polig 12V auf Steckdose 7-polig 12V</i> <i>Adaptateur micro fiche 13 broches + prise 7 broches 12V</i> </p>	005600.00	
		005600.90	
	<p> <i>Adattatore compatto spina 13 poli + presa 7 poli 12V</i> <i>Compact Adapter from 13-pin Plug to 7-pin 12V Socket</i> <i>Kompaktadapter von Stecker 13-polig 12V auf Steckdose 7-polig 12V</i> <i>Adaptateur compact fiche 13 broches + Prise 7 broches 12V</i> </p>	005546.00	
		005546.90	
	<p> <i>Adattatore spina 13 poli + presa 7 poli 12V cavo 1m</i> <i>Adapter from 13-pin plug to 7-pin 12V socket, 1m cable</i> <i>Adapter von Stecker 13-polig 12V auf Steckdose 7-polig 12V mit 1m Kabel</i> <i>Adaptateur fiche 13 broches + prise 7 broches 12V câble 1m</i> </p>	005550.00	
	<p> <i>Adattatore spina 13 poli + presa 7 poli 12V</i> <i>Adapter from 13-pin plug to 7-pin 12V socket</i> <i>Adapter von Stecker 13-polig 12V auf Steckdose 7-polig 12V</i> <i>Adaptateur fiche 13 broches + prise 7 broches 12V</i> </p>	005552.00	





PRESE 12V 13 POLI 13 PINS SOCKETS 12V 13-POLIGE STECKDOSEN 12V PRISES 12V 13 BROCHES

	Descrizione Description Beschreibung Description	Articolo Item no. Artikel-Nr. Article	Confezionamento Packaging Verpackung Emballage
	<p> <i>Preso 13 poli 12V parcheggio</i> <i>13-pin 12V parking Socket</i> <i>Parksteckdose 13-polig 12V</i> <i>Prise 13 broches 12V de repos</i> </p>	004216.00	
	<p> <i>Preso 13 poli 12V volante</i> <i>13 pin 12V Coupling socket</i> <i>Kupplungssteckdose 13-polig 12V</i> <i>13 broches 12V volante</i> </p>	004210.00	





CABLAGGI 12V 13 POLI 13 POLE WIRING HARNESSES 12V 13-POLIGE ELEKTROSÄTZE 12V CABLAGES ÉLECTRIQUES 13 BROCHES 12V

	Descrizione Description Beschreibung Description	Articolo Item no. Artikel-Nr. Article	Confezionamento Packaging Verpackung Emballage
	Kit elettrico con presa 13 poli 12V e cablaggio universale Electrical kit equipped with 12V 13 pole socket and universal wiring harness Elektrosatz mit 13-poliger Steckdose 12V und Universalkabel Kit électrique avec prise 13 broches 12V et câblage universel	002502.00	
	Kit elettrico con presa 13 poli 12V e cablaggio universale con centralina elettronica CELU Electrical kit equipped with 12V 13 pole socket, universal wiring harness and CELU control unit Elektrosatz mit 13-poliger Steckdose 12V, Universalkabel und elektronischem Steuergerät CELU Kit électrique avec prise 13 broches 12V, câblage universel et centrale électronique CELU	002503.61	
	Kit elettrico con presa 13 poli 12V e cablaggio universale con centralina elettronica CELU CK Electrical kit equipped with 12V 13 pole socket, universal wiring harness and CELU CK control unit Elektrosatz mit 13-poliger Steckdose 12V, Universalkabel und elektronischem Steuergerät CELU CK Kit électrique avec prise 13 broches 12V, câblage universel et centrale électronique CELU CK	002505.64	

CENTRALINE CONTROL UNITS STEUERGERÄTE CENTRALES ÉLECTRONIQUES CENTRALINE CONT

	Descrizione Description Beschreibung Description	Articolo Item no. Artikel-Nr. Article	Confezionamento Packaging Verpackung Emballage
	Centralina elettrica CELU per Kit elettrico cod. 00250300 CELU control unit for wiring harness 00250300 CELU Steuergerät für Elektrosatz 00250300 Centrale électronique CELU pour câblage 00250300	006062.00	
	Centralina elettrica CELU CK per Kit elettrico cod. 00250500 CELU CK control unit for wiring harness ref. 00250500 CELU CK Steuergerät für Elektrosatz 00250500 Centrale électronique CELU CK pour câblage 00250500	006063.62	

CAVI ADR ADR CABLES ADR KABEL CÂBLES ADR CAVI ADR ADR CABLES ADR KABEL CÂBLES ADR

	Materiale cavo Cable made of Kabelmaterial Matériel câble	Formazione cavo Section Querschnitt Formation câble	Sezione cavo Cable diameter Kabeldurchmesser Section câble	Lunghezza Length Länge Longueur	Articolo Item no. Artikel-Nr. Article	Confezionamento Packaging Verpackung Emballage
	Poliuretano Polyurethane Poliurethan Polyuréthane (TPU)	3x2,5+10x1,5 mm ²	Ø 13,5 mm	50 m	002014.00	
				500 m	002015.00	

Cavo con sezioni cavetti secondo la norma ISO 4141 disponibile a richiesta.
 Cable with wire section according to ISO 4141 available on request.
 Kabel mit Ader-Abschnitt gemäss ISO 4141 wird auf Anfrage geliefert.
 Câble avec la section des conducteurs selon la norme ISO 4141 disponible sur demande.

	Descrizione Description Beschreibung Description	Articolo Item no. Artikel-Nr. Article	Confezionamento Packaging Verpackung Emballage	
	Guarnizione posteriore prese 12V 13 poli a vite Rear protecting cap for 13-pin 12V socket with screw terminals Hintere Gummidichtung für Steckdose 13-polig 12V mit Schraubanschluss Joint arrière prises 12V 13 broches à vis	006033.00		
	Guarnizione posteriore prese 12V 13 poli a vite Rear protecting cap for 13-pin 12V socket with screw terminals Hintere Gummidichtung für Steckdose 13-polig 12V mit Schraubanschluss Joint arrière prises 12V 13 broches à vis	006058.00		
 NEW	Guarnizione posteriore flessibile per prese 12V 7 poli, uscita cavo dritta Flexible rear rubber gasket for 7 pin 12V socket, with straight cable outlet Biegeweiche hintere Gummidichtung für Steckdose 7-polig 12V, mit geradem Kabelabgang Joint arrière flexible prises 12V 7 broches, avec sortie du cable droite	006066.00		
 NEW	Guarnizione posteriore prese 12V 7 poli, uscita cavo a 90° Rear rubber gasket for 7 pin 12V socket, with 90° cable outlet Hintere Gummidichtung für Steckdose 7-polig 12V, mit 90° Kabelabgang Joint arrière prises 12V 7 broches, avec sortie du cable a 90°	006067.00		
	Gommino passacavo per spine 1 foro Rubber grommet with 1 cable outlet for plugs 1-fach Gummihaltetülle Bohrung für Stecker Chaumard en caoutchouc 1 trou pour fiche	Ø12mm	006034.00	
		Ø13,5mm Verde · Green · Grün · Vert	006043.00	
		Ø15mm	006035.00	
		Ø17mm	006036.00	
			006036.90	
	Gommino passacavo per spine 2 fori Rubber grommet with 2 cable outlets for plugs 2-fach Gummihaltetülle je Bohrloch für Stecker Chaumard en caoutchouc 2 trous pour fiche	Ø10mm	006037.00	
		Ø6,5mm	006051.00	
	Attrezzo per montaggio spina 13 poli Mounting tool for 13-pin plug Schutzdeckel / Montagewerkzeug für Stecker 13-polig Outil pour montage fiche 13 broches	006056.00		
		006056.90		
	Micro interruttore Microswitch Mikroschalter Micro interrupteur	009013.00		
	Pinza per crimpatura contatti Hand crimping tool for pins Crimpzange für Kontakte Pince a crimper les contacts	079903.00		



ISO 1185 / ISO 3731

PRESE & SPINE 24V 7 POLI

**7 PINS SOCKETS & PLUGS 24V
7-POLIGE STECKDOSEN & STECKER 24V
PRISES & FICHES 24V 7 BROCHES**

3



PRESE & SPINE 24V 7 POLI ISO 1185 / ISO 3731

Applicazioni: questi connettori sono utilizzati per il collegamento elettrico tra un veicolo trainante ed un rimorchio nel settore dei veicoli commerciali ed industriali, con impianto elettrico a 24V.

Il sistema comprende una versione N (NORMALE), realizzata secondo la normativa ISO 1185, generalmente impiegata per applicazioni standard. La versione S (SUPPLEMENTARE), realizzata secondo la normativa ISO 3731 è impiegata per ottenere collegamenti aggiuntivi. Quest'ultima si distingue per il codice colore BIANCO e per la diversa disposizione dei contatti che impedisce l'errato collegamento con la versione N.

La MEMBER'S fornisce questi connettori sia con corpo in materiale plastico che in alluminio, in alcuni modelli verniciato in nero anti-ossidazione.

Contatti in ottone nichelato ed attacchi posteriori a vite o faston (lamellari) da 6,3mm. La versione con contatti a vite è destinata principalmente al mercato del ricambio (after-market) mentre la versione con contatti faston (lamellari) è preferita dai costruttori per produzione di cablaggi in serie, grazie alla rapidità del collegamento.

La gamma delle prese comprende anche modelli speciali con 16 contatti posteriori faston (5 doppi e 2 tripli) per sdoppiare l'impianto elettrico del rimorchio, evitando l'impiego di scatole di derivazione.



7 PINS SOCKETS & PLUGS 24V ISO 1185 / ISO 3731

Use: these connectors are used for electrical connections between a vehicle and a trailer with 24V electrical system in the commercial vehicles sector.

The system consists of a N (Normal) version according to ISO 1185, generally used for standard applications, and a S (Supplementary) version according to ISO 3731 used for additional connections. The latter can be distinguished by its WHITE colouring and by the different order of the contacts, preventing thus an incorrect connection to the N version.

Member's supplies these connectors both with plastic or aluminium body; some versions are varnished with black anti-oxidating coating.

Nickel-plated brass contacts and rear 6,3 mm screw or spade terminals. The version with screw contacts is mainly intended for the spare parts market (after-market) while the spade terminals version, thanks to the fast connection, is preferably used by harness makers.

The range of plugs includes also special models with 16 rear spade contacts (5 double and 2 triple) in order to split the electrical system of the trailer, avoiding the use of junction boxes.



7-POLIGE STECKDOSEN & STECKER 24V ISO 1185 / ISO 3731

Anwendung: diese Steckverbindungen sind für den elektrischen Anschluss zwischen Zugfahrzeug und Anhänger bestimmt, und zwar für Industriefahrzeuge mit 24V Anlage.

Das System besteht aus einer im allgemeinen für Standardanschlüsse verwendeten N (Normal) Ausführung gemäß ISO 1185, und einer S (Supplementary) Ausführung gemäß ISO 3731 für zusätzliche Anschlüsse. Letztere unterscheidet sich vom N (Normal) Typ durch ihre WEISSE Farbe, sowie durch die unterschiedliche Anordnung der Kontakte, um Irrtümer beim Verbinden mit der N Ausführung zu vermeiden.

MEMBER'S liefert diese Verbindungsstecker und Steckdosen mit Gehäuse aus Kunststoff und Aluminium; bei einigen Modellen wurde schwarze Anti-Oxidierungsbehandlung vorgenommen.

Kontakte sind aus vernickeltem Messing und haben Schraub- oder Flachsteckanschlüsse mit 6,3 mm Durchmesser. Die Ausführung mit Schraubanschlüssen ist hauptsächlich für den Ersatzteilmarkt gedacht, während die Ausführung mit Flachsteckkontakten, dank der schnell auszuführenden Verbindung für die serienmäßige Kabelproduktion bevorzugt wird.

Die Produktpalette der Steckdosen bietet auch Spezialmodelle mit 16 hinteren Flachsteckanschlüssen an (5 doppelte und 2 dreifache) um die elektrische Schaltung des Anhängers ohne weitere Verteilerkasten zu ermöglichen.



PRISES & FICHES 24V 7 BROCHES ISO 1185 / ISO 3731

Applications: ces connecteurs sont utilisés pour la connexion électrique entre un véhicule tracteur et une remorque dans le secteur des véhicules commerciaux et industriels avec installation électrique à 24 V.

Le système comprend une version N (NORMALE), réalisée conformément à la normative ISO 1185, généralement employée pour des applications standard. La version S (SUPPLÉMENTAIRE), réalisée conformément à la normative ISO 3731 est employée pour obtenir des connexions supplémentaires. Cette version se distingue par le code couleur BLANC et par une disposition différente des contacts qui empêche la mauvaise connexion avec la version N.

MEMBER'S fournit ces connecteurs aussi bien avec un corps en plastique qu'en aluminium; certains modèles sont peints en noir anti-oxydation.

Contacts en laiton nickelé et attaches arrière à serre-fils ou cosses plates de 6,3 mm. La version avec contacts à serre-fils est principalement destinée au marché des pièces de rechange (aftermarket) tandis que la version avec cosses plates est préférée par les constructeurs pour la production de câblages en série, grâce à la rapidité de connexion.

La gamme des prises comprend également des modèles spéciaux avec 16 contacts arrière à cosses plates (5 doubles et 2 triples) pour dédoubler l'installation électrique de la remorque, évitant l'utilisation de dérivation.

SCHEMA DI CONNESSIONE
CONTACTS ALLOCATION
KONTAKTBELEGUNG
AFFECTATION DES CONTACTS

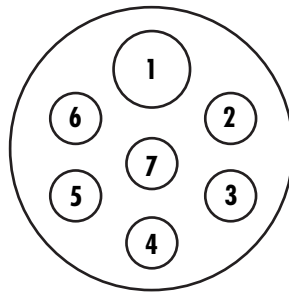













Connettori 7 poli 24V tipo N Norma ISO 1185 7 pins connectors 24V type N ISO 1185
7 POLIGE VERBINDUNGEN 24V TYP N NORM ISO 1185 Connecteurs 7 broches 24V type N Norme ISO 1185















Contacto n Contact no Kontakt Nr. Contact n	Funzione Function Funktion Fonction	Sezione Cavo Cable Diameter Kabeldurchmesser Couleur Câble	Colore cavo Colour Kabelfarbe Couleur câble
1	Massa Earth Masse Masse	2,5 mm ²	Bianco White Weiss Blanc
2	Luce di posizione , luci di ingombro , illuminazione targa SINISTRA Side lights, end outmarker lights, numberplate light LEFT Schlussleuchten, Umriss-Begrenzungsleuchte, Kennzeichenleuchte LINKS Feux de positions, feux d'encombrement, éclairage plaque GAUCHE	1,5 mm ²	Nero Black Schwarz Noir
3	Indicatori di direzione SINISTRA Indicators LEFT Fahrtrichtungsanzeiger LINKS Indicateurs de direction GAUCHE	1,5 mm ²	Giallo Yellow Gelb Jaune
4	Luci di stop Brake lights Bremsleuchte Feux stop	1,5 mm ²	Rosso Red Rot Rouge
5	Indicatori di direzione DESTRA Indicators RIGHT Fahrtrichtungsanzeiger RECHTS Indicateurs de direction DROIT	1,5 mm ²	Verde Green Grün Vert
6	Luce di posizione , luci di ingombro , illuminazione targa DESTRA Side lights, end outmarker lights, numberplate light RIGHT Schlussleuchten, Umriss-Begrenzungsleuchte, Kennzeichenleuchte RECHTS Feux de positions, feux d'encombrement, éclairage plaque DROITE	1,5 mm ²	Marrone Brown Braun Marron
7	Controllo frenatura rimorchio Control for the trailer braking system Kontrolle Bremsvorgang Anhänger Contrôle freinage remorque	1,5 mm ²	Blu Blue Blau Bleu

Connettori 7 poli 24V tipo S Norma ISO 3731 7 pins connectors 24V type S ISO 3731
7 POLIGE VERBINDUNGEN 24V TYP S NORM ISO 3731 Connecteurs 7 broches 24V type S Norme ISO 3731



















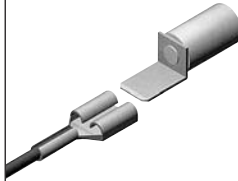

1	Massa Earth Masse Masse	2,5 mm ²	Bianco White Weiss Blanc
2	Nessuna applicazione No allocation Kein Anschluss Aucune application Signalisation raccordement remorque	1,5 mm ²	Nero Black Schwarz Noir
3	Luci di retromarcia Reverse lights Rückfahrleuchte Feux de marche arrière	1,5 mm ²	Giallo Yellow Gelb Jaune
4	Positivo di alimentazione diretto da batteria Positive direct from battery Pos. Stromversorgung direkt von Batterie Positif d'alimentation directe de batterie	2,5 mm ²	Rosso Red Rot Rouge
5	Sensore con ritorno a massa Sensor with earth return Sensor mit Rückkehrmasse Capteur avec retour à la masse	1,5 mm ²	Verde Green Grün Vert
6	Positivo di alimentazione sotto chiave avviamento Positive ignition key Pos. Stromspernung mit Zündschlüssel Positif d'alimentation sous clefs de mise en route	2,5 mm ²	Marrone Brown Braun Marron
7	Luce retro-nebbia Rear fog light Nebelschlussleuchte Feu arrière de brouillard	1,5 mm ²	Blu Blue Blau Bleu

	Materiale corpo Material Corps Material Matériel	Norma Norm Norm Norme	Tipo contatti Type of contact Anschluss Type contacts	Materiale contatti Pins made of Material Kontakt Matériel contacts	Articolo Item no. Artikel-Nr. Article	Confezionamento Packaging Verpackung Emballage
	AL	ISO 1185 DIN 72579	 N	ON	005809.00	
	AL				005809.90	
					005809.99	
	AL	ISO 3731	 S	ON	005816.00	
	AL				005816.90	
					005816.99	
					005817.00	













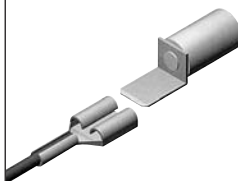



SPINE 24V 7 POLI 7 PINS PLUGS 24V 7-POLIGE STECKER 24V FICHES 24V 7 BROCHES

	Materiale corpo Material Corps Material Matériel	Norma Norm Norm Norme	Tipo contatti Type of contact Anschluss Type contacts	Materiale contatti Pins made of Material Kontakt Matériel contacts	Articolo Item no. Artikel-Nr. Article	Confezionamento Packaging Verpackung Emballage
	AL	ISO 1185 DIN 72579		ON	005909.00	
	AL				005909.90	
					005909.99	 
	AL	ISO 3731		ON	005916.00	
	AL				005916.90	
					005916.99	 
					005917.00	

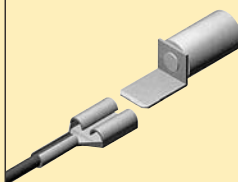





PRESE 24V 7 POLI 7 PINS SOCKETS 24V 7-POLIGE STECKDOSEN 24V PRISES 24V 7 BROCHES

	Materiale corpo Material Corps Material Matériel	Norma Norm Norm Norme	Tipo contatti Type of contact Anschluss Type contacts	Materiale contatti Pins made of Material Kontakt Matériel contacts	Articolo Item no. Artikel-Nr. Article	Confezionamento Packaging Verpackung Emballage
	AL	ISO 1185 DIN 72579	 N	ON	005807.00	
					005807.90	
					005807.99	
	AL				005812.00	
	AL	 N		ON	005810.00	
<i>Prise 7P 24V 16 attaches postérieures 7P 24V Socket with 16 rear contacts Steckdose 7P 24V mit 16 Anschlüssen Prise 7B 24V 16 jonctions postérieures</i>					005810.90	
	AL				005813.00	
<i>Prise 7P 24V 16 attaches postérieures 7P 24V Socket with 16 rear contacts Steckdose 7P 24V mit 16 Anschlüssen Prise 7B 24V 16 jonctions postérieures</i>						
	AL	ISO 3731	 S	ON	005811.00	
					005811.90	
					005811.99	
	AL				005814.00	

SPINE 24V 7 POLI 7 PINS PLUGS 24V 7-POLIGE STECKER 24V FICHES 24V 7 BROCHES

	Materiale corpo Material Corps Material Matériel	Norma Norm Norm Norme	Tipo contatti Type of contact Anschluss Type contacts	Materiale contatti Pins made of Material Kontakt Matériel contacts	Articolo Item no. Artikel-Nr. Article	Confezionamento Packaging Verpackung Emballage
	AL	ISO 1185 DIN 72579 		ON	005907. 00	
					005907. 90	
					005907. 99	
	AL				005912. 00	
	AL	ISO 3731 		ON	005911. 00	
					005911. 90	
					005911. 99	
	AL				005914. 00	

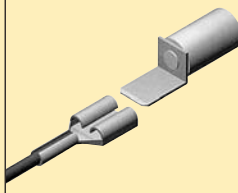







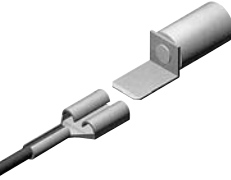

PRESE 24V 7 POLI 7 PINS SOCKETS 24V 7-POLIGE STECKDOSEN 24V PRISES 24V 7 BROCHES

	Materiale corpo Material Corps Material Matériel	Norma Norm Norm Norme	Tipo contatti Type of contact Anschluss Type contacts	Materiale contatti Pins made of Material Kontakt Matériel contacts	Articolo Item no. Artikel-Nr. Article	Confezionamento Packaging Verpackung Emballage
	<p>PL</p>	<p>ISO 1185 DIN 72579</p>  <p>N</p>		<p>ON</p>	005851.00 	
					005851.90 	
					005851.99  	
	<p>PL</p>	<p>ISO 3731</p>  <p>S</p>		<p>ON</p>	005861.00 	
					005861.90 	
					005861.99  	
  <p><i>Presa 7P 24V 16 attacchi posteriori 7P 24V Socket with 16 rear contacts Steckdose 7P 24V mit 16 Anschlüssen Prise 7P 24V 16 attelages arrière</i></p>	<p>PL</p>	<p>ISO 1185 DIN 72579</p>  <p>N</p>		<p>ON</p>	005852.00 	
					005852.90 	
					005852.99  	
					005853.00 	
  <p><i>Presa 7P 24V 16 attacchi posteriori 7P 24V Socket with 16 rear contacts Steckdose 7P 24V mit 16 Anschlüssen Prise 7P 24V 16 attelages arrière</i></p>	<p>PL</p>	<p>ISO 3731</p>  <p>S</p>		<p>ON</p>	005862.00 	
					005862.90 	
					005862.99  	
					005863.00 	



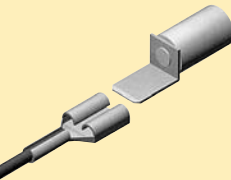





SPINE 24V 7 POLI 7 PINS PLUGS 24V 7-POLIGE STECKER 24V FICHES 24V 7 BROCHES

	Materiale corpo Material Corps Material Matériel	Norma Norm Norm Norme	Tipo contatti Type of contact Anschluss Type contacts	Materiale contatti Pins made of Material Kontakt Matériel contacts	Articolo Item no. Artikel-Nr. Article	Confezionamento Packaging Verpackung Emballage
		ISO 1185 DIN 72579  N			005951.00 	
					005951.90 	
					005951.99  	
		ISO 3731  S			005961.00 	
					005961.90 	
					005961.99  	
		ISO 1185 DIN 72579  N			005952.00 	
					005952.90 	
					005952.99  	
		ISO 3731  S			005962.00 	
					005962.90 	
					005962.99  	

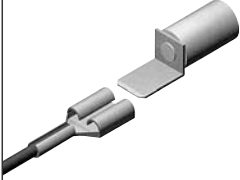
PRESE 24V 7 POLI 7 PINS SOCKETS 24V 7-POLIGE STECKDOSEN 24V PRISES 24V 7 BROCHES



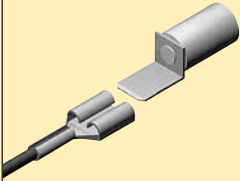

	Materiale corpo Material Corps Material Matériel	Norma Norm Norm Norme	Tipo contatti Type of contact Anschluss Type contacts	Materiale contatti Pins made of Material Kontakt Matériel contacts	Articolo Item no. Artikel-Nr. Article	Confezionamento Packaging Verpackung Emballage
 <p>Preso 7P 24V ADR 7P 24V ADR Socket ADR Steckdose 7P 24V Prise 7P 24V ADR</p>	<p>PL</p>	<p>ISO 1185 DIN 72579</p>  <p>N</p>		<p>ON</p>	<p>005854.00</p> 	
 <p>Preso 7P 24V 16 attacchi posteriori ADR 7P 24V ADR Socket with 16 rear contacts ADR Steckdose 7P 24V mit 16 Anschlüssen Prise 7P 24V 16 attelages arrière ADR</p>					<p>005850.00</p> 	
 <p>Preso 7P 24V ADR 7P 24V ADR Socket ADR Steckdose 7P 24V Prise 7P 24V ADR</p>	<p>PL</p>	<p>ISO 3731</p>  <p>S</p>		<p>ON</p>	<p>005864.00</p> 	
 <p>Preso 7P 24V 16 attacchi posteriori ADR 7P 24V ADR Socket with 16 rear contacts ADR Steckdose 7P 24V mit 16 Anschlüssen Prise 7P 24V 16 attelages arrière ADR</p>					<p>005860.00</p> 	
 <p>Preso 24V di parcheggio 24V PARKING Socket Parksteckdose 24V Prise 24V de repos</p>	<p>PL</p>				<p>005800.00</p> 	

SPINE 24V 7 POLI 7 PINS PLUGS 24V 7-POLIGE STECKER 24V FICHES 24V 7 BROCHES

	Materiale corpo Material Corps Material Matériel	Norma Norm Norm Norme	Tipo contatti Type of contact Anschluss Type contacts	Materiale contatti Pins made of Material Kontakt Matériel contacts	Articolo Item no. Artikel-Nr. Article	Confezionamento Packaging Verpackung Emballage
 <p data-bbox="347 707 496 797"> Spina 7 poli 24V ADR 7 pin 24V ADR Plug ADR Stecker 7-polig 24V Fiche 7 broches 24V ADR </p>	<p data-bbox="555 483 603 528">PL</p>	<p data-bbox="651 383 754 456"> ISO 1185 DIN 72579 </p>  <p data-bbox="691 568 722 607">N</p>		<p data-bbox="1066 483 1114 528">ON</p>	<p data-bbox="1177 488 1353 521">005954.00</p>	
 <p data-bbox="347 1312 496 1402"> Spina 7 poli 24V ADR 7 pin 24V ADR Plug ADR Stecker 7-polig 24V Fiche 7 broches 24V ADR </p>	<p data-bbox="555 1088 603 1133">PL</p>	<p data-bbox="675 987 730 1061"> ISO 3731 </p>  <p data-bbox="691 1173 722 1211">S</p>		<p data-bbox="1066 1088 1114 1133">ON</p>	<p data-bbox="1177 1093 1353 1126">005964.00</p>	

	Norma Norm Norm Norme	Descrizione Description Beschreibung Description	Articolo Item no. Artikel-Nr. Article	Confezionamento Packaging Verpackung Emballage
 NEW	ISO 1185-11446  N	<i>Trasformatore di tensione 7 poli N 24V/13 poli 12V</i> Power converter with 24V 7 pole N plug + 12V 13 pole N socket <i>Spannungswandler mit 24V/7-pol. N-Stecker + 12V/13-pol. N-Steckdose</i> Transformateur de tension avec fiche N 7 broches 24V + prise N 13 broches 12V	005609.00	
 NEW	ISO 1185-1724  N	<i>Trasformatore di tensione 7 poli N 24V/7 poli 12V</i> Power converter with 24V 7 pole N plug + 12V 7 pole N socket <i>Spannungswandler mit 24V/7-pol. N-Stecker + 12V/7-pol. N-Steckdose</i> Transformateur de tension avec fiche N 7 broches 24V + prise N 7 broches 12V	005610.00	
 NEW	ISO 3731-3732  S	<i>Trasformatore di tensione 7 poli S 24V/7 poli 12V</i> Power converter with 24V 7 pole S plug + 12V 7 pole S socket <i>Spannungswandler mit 24V/7-pol. Zusatz-Stecker + 12V/7-pol. Zusatz-Steckdose</i> Transformateur de tension avec fiche S 7 broches 24V + prise S 7 broches 12V	005611.00	

CAVI ADR ADR CABLES ADR KABEL CÂBLES ADR CAVI ADR ADR CABLES ADR KABEL CÂBLES ADR

	Materiale cavo Cable made of Kabelmaterial Matériel câble	Formazione cavo Section Querschnitt Formation câble	Sezione cavo Cable diameter Kabeldurchmesser Section câble	Lunghezza Length Länge Longueur	Articolo Item no. Artikel-Nr. Article	Confezionamento Packaging Verpackung Emballage
	Poliuretano Polyurethane Poliurethan Polyuréthane (TPU)	6x1+1x2 mm ²	Ø 9,8 mm	50 m	002008.00	
				500 m	002009.00	

Cavo con sezioni cavetti secondo la norma ISO 4141 disponibile a richiesta.
 Cable with wire section according to ISO 4141 available on request.
 Kabel mit Ader-Abschnitt gemäss ISO 4141 wird auf Anfrage geliefert.
 Câble avec la section des conducteurs selon la norme ISO 4141 disponible sur demande.

	Descrizione Description Beschreibung Description	Articolo Item no. Artikel-Nr. Article	Confezionamento Packaging Verpackung Emballage
	Guarnizione posteriore prese 24V 7 poli Rear protecting cap for socket 24V 7 pin Hintere Gummischutzkappe für Steckdose 7-polig 24V Joint arrière prises 24V 7 broches	006003.00	
		006003.60	
	Cappuccio posteriore spine 24V 7 poli Rear protecting cap for plugs 24V 7 pin Hintere Gummischutzkappe für Stecker 7-polig 24V Joint arrière fiches 24V 7 broches	006008.00	
	Molla acciaio + Guarnizione spine 24V 7 poli Antikink spring + protecting cap for 7 pin 24V plug Knickschutzstahlfeder + Gummischutzkappe für Stecker 7-polig 24V Ressort acier + joint fiches 24V 7 broches	006010.00	
	Guarnizione posteriore 90° prese 24V 7 poli Rear protecting cap with cable outlet 90° for 7 pin 24V socket Hintere Gummischutzkappe mit 90° Kabelabgang für Steckdose 7-polig 24V Joint arrière 90° prises 24V 7 broches	006029.00	
	Guarnizione posteriore prese ADR 24V 7 poli Rear protecting cap for ADR socket 24V 7 pin Hintere Gummischutzkappe für ADR Steckdose 7-polig 24V Joint arrière prises ADR 24V 7 broches	006059.00	
	Blocchetto con cavetti prese 24V 7 poli Wired flat terminal coupling for 7 pin 24V socket Flachsteckkupplung mit Kabelsatz komplett montiert für Steckdose 7-polig 24V Connecteur avec câbles prises 24V 7 broches	006000.00	
	Blocchetto prese 24V 7 poli Flat terminal coupling for 7 pin 24V socket Flachsteckkupplung ohne Verbindungskabeln für Steckdose 7-polig 24V Connecteur prises 24V 7 broches	006030.00	
	Blocchetto con cavetti spine 24V 7 poli Wired flat terminal coupling for 7 pin 24V plug Flachsteckkupplung mit Kabelsatz komplett montiert für Stecker 7-polig 24V Connecteur avec câbles fiches 24V 7 broches	006001.00	
	Blocchetto spine 24V 7 poli Flat terminal coupling for 7 pin 24V plug Flachsteckkupplung ohne Verbindungskabeln für Stecker 7-polig 24V Connecteur fiches 24V 7 broches	006031.00	
		006031.60	



4

SPIRALI 12/24V 7 POLI

7 PINS COILS 12/24V

7-POLIGE SPIRALKABEL 12/24V

CORDONS ÉLECTRIQUES 12/24V 7 BROCHES



SPIRALI 12/24V 7 POLI

Applicazioni: Le spirali elettriche con spine 7 poli 24V vengono utilizzate per effettuare il collegamento elettrico tra una motrice ed un semirimorchio nel settore dei veicoli commerciali ed industriali.

Questi prodotti vengono realizzati con un cavo conforme alla normativa ISO 4141 con guaina esterna in HYTREL® (TEEE) o in TPU (Poliuretano). L'HYTREL® (TEEE) ha ottime caratteristiche di elasticità e di robustezza meccanica e resistenza agli aggressivi chimici ed all'abrasione; è il materiale preferito per forniture di 1° impianto. È disponibile in due versioni : con un diametro di spira di 60 mm. e di 30 mm.

Il TPU (Poliuretano) è invece caratterizzato da una maggiore morbidezza ed elasticità anche alle basse temperature. È realizzato unicamente con diametro spira 20 mm. che riduce sensibilmente l'ingombro creato dai numerosi collegamenti esistenti tra motrice e rimorchio. Queste caratteristiche lo rendono particolarmente apprezzato dal mercato dell'aftermarket.

Le spirali sono disponibili con spine rispondenti alla normativa ISO 1185 per il connettore Normale ed ISO 3731 per il connettore Supplementare; possono avere sia il corpo in alluminio sia in materiale plastico. Il punto di congiunzione tra il cavo e la spina è protetto da manicotti in gomma oppure da molle a spirale in acciaio.

A completamento della gamma vi sono anche spirali con spine "costampate": le spine vengono realizzate mediante una sofisticata tecnica di sovra-stampaggio che ingloba in un blocco unico il portacontatti ed il cavo elettrico. La caratteristica principale che le contraddistingue è l'impermeabilità assoluta ad acqua e polvere dei connettori (grado di protezione IP65).

I cavi spirale, indipendentemente dal tipo di materiale utilizzato, sono disponibili in diverse versioni con lunghezza di lavoro da 3 a 4,5 m.



7 PINS COILS 12/24V

Use: 7p 24V electrical coils are used for the electrical connection between a truck tractor and a semitrailer in the commercial vehicles sector.

These products are supplied with a cable conforming to ISO 4141, and with external sheath made of HYTREL® (TEEE) or POLYURETHANE(TPU).

HYTREL® (TEEE) has excellent qualities as regards elasticity and mechanical resistance as well as resistance against chemical agents and abrasion and is used preferably by OEM's. Available are two versions, with 60 mm and 30 mm turn diameter respectively.

POLYURETHANE (TPU) on the other hand maintains a greater smoothness and elasticity even at low temperatures. Available only with 20 mm turn diameter, thus minimizing the space taken by the numerous connections between vehicle and trailer. Thanks to these characteristics it is especially used in the aftermarket.

The coils are available with plugs according to ISO 1185 for the normal connector and ISO 3731 for the supplementary connector, with plastic or aluminium body. The connection point between cable and plug is protected by a rubber protection grommet or by steel cable guards.

Coils with moulded plugs complete the range: the plugs are produced with an innovative technological moulding process where the insert and the cable are a single block. Their main advantage is their absolute watertightness and dustproofness (IP protection grade: IP 65)

The coils, independently from the type of material used, are available in several versions with working lengths between 3 and 4,5 m.



7-POLIGE SPIRALKABEL 12/24V

Anwendung: die 24V Spiralkabel mit 7-poligen Steckern sind für den elektrischen Anschluss zwischen Zugfahrzeug und Anhänger im Bereich der Nutzfahrzeuge bestimmt.

Diese Produkte werden mit einem ISO 4141 entsprechenden Kabel produziert, mit äußerer Ummantelung aus HYTREL® (TEEE) oder aus POLYURETHAN(TPU).

HYTREL® (TEEE) ist in hohem Maße elastisch und widerstandsfähig - auch gegen chemische Stoffen und Abnutzung - und wird bei der Fertigung als Material vorgezogen. Verfügbar mit 60 mm und 30 mm Windungsdurchmesser.

POLYURETHAN (TPU) dagegen bleibt auch bei niedrigeren Temperaturen weich und elastisch. Verfügbar nur mit platzsparendem 20 mm Windungsdurchmesser, der dazu beiträgt, den Umfang der zahlreichen Verbindungen zwischen Zugfahrzeug und Anhänger zu reduzieren. Dank dieser Charakteristika ist das Produkt besonders für den Ersatzteilmarkt attraktiv.

Die Spiralkabel sind verfügbar mit Steckern gemäß ISO 1185 (N-Ausführung) und ISO 3731 (S-Ausführung); Gehäuse aus Aluminium oder aus Kunststoff. Der Anschlusspunkt zwischen Kabel und Stecker wird mit einer Knickschutzhülse oder mit stählernen Spiralfedern versehen.

Die Produktpalette wird mit Spiralkabel mit "angegossenen" Steckern ergänzt: die Stecker werden mittels einem innovativem Produktionsverfahren produziert, wobei der Kontakthalter direkt an dem Kabel angegossen wird. Hauptvorteil ist die absolute Wasser- und Staubfestigkeit (Schutzgrad IP65)

Unabhängig vom verwendeten Material sind die Spiralkabel in verschiedenen Ausführungen mit Arbeitslängen von 3 bis 4,5m erhältlich.



CORDONS ÉLECTRIQUES 12/24V 7 BROCHES

Applications: Les cordons électriques avec fiches 7 broches 24 V sont utilisés pour effectuer la connexion électrique entre un véhicule tracteur et une semi-remorque dans le secteur des véhicules commerciaux et industriels.

Ces produits sont réalisés avec un câble conforme à la normative ISO 4141 avec une gaine extérieure en HYTREL® (TEEE) ou en (POLYURÉTHANE) TPU.

Le HYTREL® (TEEE) a d'excellentes caractéristiques d'élasticité et de robustesse mécanique, de résistance à l'agressivité chimique et à l'abrasion; c'est le matériau préféré pour la fourniture de 1^o installation. Il est disponible en deux versions: avec un diamètre de spire de 60 mm et de 30 mm.

Le POLYURÉTHANE (TPU) se caractérise au contraire par une plus grande souplesse et élasticité même à de basses températures. C'est réalisé uniquement avec un diamètre de spire de 20 mm qui réduit sensiblement l'encombrement créé par les nombreuses connexions existant entre le véhicule tracteur et la remorque. Ces caractéristiques le rendent particulièrement apprécié par le marché de l'after-market.

Les cordons électriques sont disponibles avec des fiches répondant à la normative ISO 1185 pour le connecteur Normal et ISO 3731 pour le connecteur Supplémentaire; elles peuvent avoir soit le corps en aluminium soit en plastique. Le point de jonction entre le câble et la fiche est protégé par des manchons en caoutchouc ou par des ressorts à spirales en acier.

Pour compléter la gamme il y a également des spirales avec fiches "surmoulées": les fiches sont réalisées avec une technique sophistiquée de surmoulage qui englobe dans un bloc unique les portes-contacts et le câble électrique. Sa principale caractéristique est l'étanchéité absolue à l'eau et à la poussière des connecteurs (degré de protection IP65) Tous les cordons, indépendamment du type de matériel utilisé, sont disponibles en diverses versions avec des longueurs de travail allant de 3 à 4,5 m.

SCHEMA DI CONNESSIONE
CONTACTS ALLOCATION
KONTAKTBELEGUNG
AFFECTATION DES CONTACTS

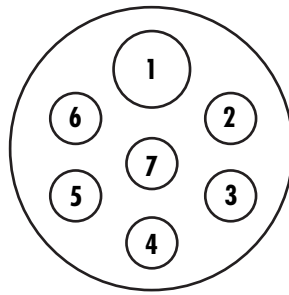





















Connettori 7 poli 24V tipo N Norma ISO 1185 7 pins connectors 24V type N ISO 1185
7 POLIGE VERBINDUNGEN 24V TYP N NORM ISO 1185 Connecteurs 7 broches 24V type N Norme ISO 1185











Contacto n Contact no Kontakt Nr. Contact n	Funzione Function Funktion Fonction	Sezione Cavo Cable Diameter Kabeldurchmesser Couleur Câble	Colore cavo Colour Kabelfarbe Couleur câble
1	Massa Earth Masse Masse	2,5 mm ²	Bianco White Weiss Blanc
2	Luce di posizione , luci di ingombro , illuminazione targa SINISTRA Side lights, end outmarker lights, numberplate light LEFT Schlussleuchten, Umriss-Begrenzungsleuchte, Kennzeichenleuchte LINKS Feux de positions, feux d'encombrement, éclairage plaque GAUCHE	1,5 mm ²	Nero Black Schwarz Noir
3	Indicatori di direzione SINISTRA Indicators LEFT Fahrtrichtungsanzeiger LINKS Indicateurs de direction GAUCHE	1,5 mm ²	Giallo Yellow Gelb Jaune
4	Luci di stop Brake lights Bremsleuchte Feux stop	1,5 mm ²	Rosso Red Rot Rouge
5	Indicatori di direzione DESTRA Indicators RIGHT Fahrtrichtungsanzeiger RECHTS Indicateurs de direction DROIT	1,5 mm ²	Verde Green Grün Vert
6	Luce di posizione , luci di ingombro , illuminazione targa DESTRA Side lights, end outmarker lights, numberplate light RIGHT Schlussleuchten, Umriss-Begrenzungsleuchte, Kennzeichenleuchte RECHTS Feux de positions, feux d'encombrement, éclairage plaque DROITE	1,5 mm ²	Marrone Brown Braun Marron
7	Controllo frenatura rimorchio Control for the trailer braking system Kontrolle Bremsvorgang Anhänger Contrôle freinage remorque	1,5 mm ²	Blu Blue Blau Bleu

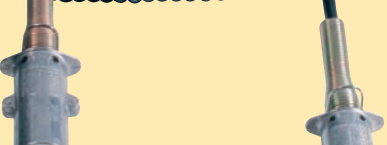

Connettori 7 poli 24V tipo S Norma ISO 3731 7 pins connectors 24V type S ISO 3731
7 POLIGE VERBINDUNGEN 24V TYP S NORM ISO 3731 Connecteurs 7 broches 24V type S Norme ISO 3731

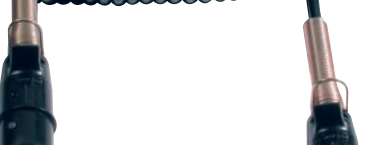
1	Massa Earth Masse Masse	2,5 mm ²	Bianco White Weiss Blanc
2	Nessuna applicazione No allocation Kein Anschluss Aucune application Signalisation raccordement remorque	1,5 mm ²	Nero Black Schwarz Noir
3	Luci di retromarcia Reverse lights Rückfahrleuchte Feux de marche arrière	1,5 mm ²	Giallo Yellow Gelb Jaune
4	Positivo di alimentazione diretto da batteria Positive direct from battery Pos. Stromversorgung direkt von Batterie Positif d'alimentation directe de batterie	2,5 mm ²	Rosso Red Rot Rouge
5	Sensore con ritorno a massa Sensor with earth return Sensor mit Rückkehrmasse Capteur avec retour à la masse	1,5 mm ²	Verde Green Grün Vert
6	Positivo di alimentazione sotto chiave avviamento Positive ignition key Pos. Stromspernung mit Zündschlüssel Positif d'alimentation sous clefs de mise en route	2,5 mm ²	Marrone Brown Braun Marron
7	Luce retro-nebbia Rear fog light Nebelschlussleuchte Feu arrière de brouillard	1,5 mm ²	Blu Blue Blau Bleu

	Materiale cavo Cable made of Kabelmaterial Matériel câble	Formazione cavo Section Querschnitt Formation câble	Sezione cavo Cable diameter Kabeldurchmesser Section câble	Diametro spira Turn diameter Windungsdurchmesser Diamètre spirale	L.L. Max. estensibile Max. extendable W.L. Max. ausziehbare A.L. Max. extensible L.T.	
	Poliuretano Polyurethane Poliurethan Polyuréthane (TPU)	$6 \times 1 + 1 \times 1,5$ mm^2	$\varnothing 10,3$ mm	$\varnothing 20$ mm	3,5 m	
					4,5 m	
					3,5 m	
					4,5 m	
	HYTREL® (TEEE)	$6 \times 1 + 1 \times 2,5$ mm^2	$\varnothing 10,5$ mm	$\varnothing 40$ mm	3,5 m	
					4,5 m	
	HYTREL® (TEEE)	$6 \times 1 + 1 \times 2,5$ mm^2	$\varnothing 10,5$ mm	$\varnothing 40$ mm	3,5 m	
					4,5 m	
					3,5 m	
					4,5 m	



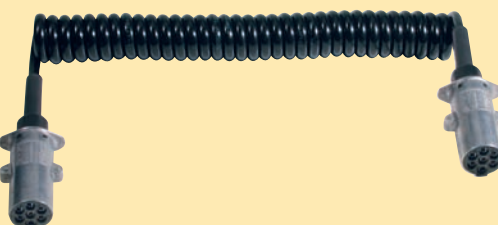
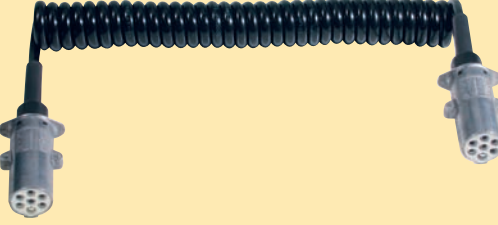













Materiale spina Plug made of Steckmaterial Matériel fiche	Norma Norm Norm Norme	Descrizione Description Beschreibung Description	Articolo Item no. Artikel-Nr. Article	Confezionamento Packaging Verpackung Emballage	Accessori Accessories Zubehör Accessoires
	ISO 1185 DIN 72579  N	<i>Spine Costampate 24V 7 poli tipo N</i> 24V 7 pin Moulded Plugs, N type <i>Angegossenen 24V 7-polig N-Steckern</i> <i>Fiches Surmoulées 7 broches 24V type N</i>	005508. 90		
			005508. 80		
	ISO 3731  S	<i>Spine Costampate 24V 7 poli tipo S</i> 24V 7 pin Moulded Plugs, S type <i>Angegossenen 24V 7-polig S-Steckern</i> <i>Fiches Surmoulées 7 broches 24V type S</i>	005509. 90		
			005509. 80		
		<i>Senza spine</i> <i>Without Plugs</i> <i>Ohne Stecker</i> <i>Sans Fiches</i>	005523. 00		
			005538. 00		
	ISO 1185 DIN 72579  N	<i>Spine 24V 7 poli in Alluminio tipo N</i> 24V 7 pin Aluminium Plugs, N type 24V Aluminium 7-polig N-Steckern <i>Fiches 24V 7 broches en Aluminium type N</i>	005526. 00		<i>Mollone in acciaio</i> <i>Antikink spring</i> <i>Knickschutzfeder</i> <i>Ressort en acier</i>
			005544. 00		
	ISO 3731  S	<i>Spine 24V 7 poli in Alluminio tipo S</i> 24V 7 pin Aluminium Plugs, S type 24V Aluminium 7-polig S-Steckern <i>Fiches 24V 7 broches en Aluminium type S</i>	005527. 00		
			005545. 00		

	Materiale cavo Cable made of Kabelmaterial Matériel câble	Formazione cavo Section Querschnitt Formation câble	Sezione cavo Cable diameter Kabeldurchmesser Section câble	Diametro spira Turn diameter Windungsdurchmesser Diamètre spirale	L.L. Max. estensibile Max. extendable W.L. Max. ausziehbare A.L. Max. extensible L.T.	
	HYTREL® (TEEE)	6x1+1x2,5 mm ²	Ø 10,5 mm	Ø 60 mm	3,5 m	
					4,5 m	
	HYTREL® (TEEE)	6x1+1x2,5 mm ²	Ø 10,5 mm	Ø 60 mm	3 m	
					3,5 m	
					4,5 m	
					3 m	
					3,5 m	
					4,5 m	
	HYTREL® (TEEE)	6x1+1x2,5 mm ²	Ø 10,5 mm	Ø 60 mm	3 m	
					3,5 m	
					4,5 m	
					3 m	
					3,5 m	
					4,5 m	

	Materiale cavo Cable made of Kabelmaterial Matériel câble	Formazione cavo Section Querschnitt Formation câble	Sezione cavo Cable diameter Kabeldurchmesser Section câble	Diametro spira Turn diameter Windungsdurchmesser Diamètre spirale	L.L. Max. estensibile Max. extendable W.L. Max. ausziehbare A.L. Max. extensible L.T.					
	Poliuretano Polyurethane Poliurethan Polyuréthane (TPU)	6x1+1x1,5 mm ²	Ø 10,3 mm	Ø 20 mm	3,5 m					
					4,5 m					
	Poliuretano Polyurethane Poliurethan Polyuréthane (TPU)	6x1+1x1,5 mm ²	Ø 10,3 mm	Ø 20 mm	3,5 m					
					4,5 m					
									3,5 m	
					4,5 m					
	Poliuretano Polyurethane Poliurethan Polyuréthane (TPU)	6x1+1x1,5 mm ²	Ø 10,3 mm	Ø 20 mm	3,5 m					
					4,5 m					
									3,5 m	
					4,5 m					

	Materiale cavo Cable made of Kabelmaterial Matériel câble	Formazione cavo Section Querschnitt Formation câble	Sezione cavo Cable diameter Kabeldurchmesser Section câble	Diametro spira Turn diameter Windungsdurchmesser Diamètre spirale	L.L. Max. estensibile Max. extendable W.L. Max. ausziehbare A.L. Max. extensible L.T.	
	Poliuretano Polyurethane Poliurethan Polyuréthane (TPU)	$6 \times 1 + 1 \times 1,5$ mm^2	$\varnothing 10,3$ mm	$\varnothing 20$ mm	1,5 m	
	Poliuretano Polyurethane Poliurethan Polyuréthane (TPU)	$6 \times 1 + 1 \times 1,5$ mm^2	$\varnothing 10,3$ mm	$\varnothing 20$ mm	3,5 m	
	HYTREL® (TEEE)	$6 \times 1 + 1 \times 2,5$ mm^2	$\varnothing 10,5$ mm	$\varnothing 60$ mm	3,5 m	
	HYTREL® (TEEE)	$6 \times 1 + 1 \times 2,5$ mm^2	$\varnothing 10,5$ mm	$\varnothing 60$ mm	3,5 m	

SPIRALI 12/24V 7 POLI 7 PINS COILS 12/24V 7-POLIGE SPIRALKABEL 12/24V CORDONS ÉLECTRIQUES 12/24V 7 BROCHES

Materiale spina Plug made of Stecker material Matériel fiche	Norma Norm Norm Norme	Descrizione Description Beschreibung Description	Articolo Item no. Artikel-Nr. Article	Confezionamento Packaging Verpackung Emballage	Accessori Accessories Zubehör Accessoires
	ISO 1724  N	Spine 12V 7 poli in Plastica tipo N 12V 7 pin Plastic Plugs, N type 12V Kunststoff 7-polig N-Steckern Fiches 12V 7 broches en Plastique type N	005501. 91		
	ISO 1724  N	Spine 12V 7 poli in Alluminio tipo N 12V 7 pin Aluminium Plugs, N type 12V Aluminium 7-polig N-Steckern Fiches 12V 7 broches en Aluminium type N	005513. 00		
	ISO 1724  N	Spine 12V 7 poli in Plastica tipo N 12V 7 pin Plastic Plugs, N type 12V Kunststoff 7-polig N-Steckern Fiches 12V 7 broches en Plastique type N	005504. 00		
	ISO 1724  N	Spine 12V 7 poli in Alluminio tipo N 12V 7 pin Aluminium Plugs, N type Mit 12V 7-polig Aluminium 7-polig N-Steckern Fiches 12V 7 broches en Aluminium type N	005531. 00		
	ISO ISO 1185 1724 DIN 72579   N	Spine 12V+24V 7 poli in Alluminio tipo N 1x 12V N Aluminium plug and 1 x 24V N aluminium plug Mit 1 x 12V ALU N-Stecker + 1 x 24V ALU N-Stecker Fiches 12V+24V 7 broches en Aluminium type N	005532. 00		



ISO/DIS 12098

5

PRESE & SPINE 24V 15 POLI
15 PINS SOCKETS & PLUGS 24V
15-POLIGE STECKDOSEN & STECKER 24V
PRISES & FICHES 24V 15 BROCHES



PRESE & SPINE 24V 15 POLI ISO/DIS 12098

Applicazioni: questi connettori sono utilizzati per il collegamento elettrico tra un veicolo trainante ed un rimorchio nel settore dei veicoli commerciali ed industriali, con impianto elettrico a 24V.

Questo nuovo sistema raggruppa in un unico connettore tutti i collegamenti previsti nel vecchio sistema 24V a 7 poli tipo N e tipo S. È caratterizzato da una maggiore robustezza meccanica, da una maggiore impermeabilità all'acqua e garantisce un collegamento elettrico più affidabile e sicuro. La spina si collega alla presa mediante una leva di aggancio anti-sfilamento in acciaio. Queste caratteristiche li rendono perfettamente rispondenti alle specifiche tecniche dettate dalla Normativa ADR/GGVS per applicazioni su veicoli adibiti al trasporto merci pericolose.

Contatti in Ottone nichelato, attacchi posteriori da crimpare mediante un apposito utensile, oppure a vite (indicati per il mercato del ricambio).

Sono disponibili adattatori di vario tipo per collegare il vecchio sistema 7 poli N ed S e il nuovo sistema a 15 poli, o viceversa.



15 PINS SOCKETS & PLUGS 24V ISO/DIS 12098

Use: these connectors are used for electrical connections between a vehicle and a trailer with 24V electrical system in the commercial vehicles sector.

This new system provides in a single connector for all the connections required in the former 24V 7p system type N and S. Advantages are greater mechanical resistance, higher watertightness as well as a more reliable and safe electrical connection. The plug is connected to the socket by a steel lock bracket to avoid accidental disconnection. The 15p sockets and plugs fully comply to the technical requirements of ADR/GGVS norms regarding vehicles transporting hazardous goods.

Nickel-plated brass contacts, rear terminals to be crimped with a special tool, or screw-on (suitable for the spare parts market).

Several types of adaptors are available to connect the old 7p N and S system to the new 15p system, and vice versa.



15-POLIGE STECKDOSEN & STECKER 24V ISO/DIS 12098

Anwendung: diese Steckverbindungen sind für den elektrischen Anschluss zwischen einem Zugfahrzeug und einem Anhänger im Bereich Nutzfahrzeuge mit 24V bestimmt.

Mit dem neuen System können alle im herkömmlichen 24V 7-poligen System Typ N und S vorgesehenen Anschlüsse auf einmal ausgeführt werden. Dank der größeren Widerstandsfähigkeit und Wasserdichte ist der Anschluss zuverlässiger und sicherer. Um das Herauslösen des Steckers zu vermeiden, wird der Stecker mittels einer Verriegelung aus Stahl in die Steckdose eingesetzt. Die neuen Modelle entsprechen mit diesen Charakteristika den technischen Spezifikationen der ADR/GGVS Norm für Fahrzeuge die Gefahrgut transportieren.

Kontakte aus vernickeltem Messing, hintere mit Crimpzange anzuschliessende Crimpanschlüsse, oder Schraubanschlüsse (geeignet für den Ersatzteilmarkt).

Erhältlich sind auch verschiedene Typen von Adapter um das herkömmliche 7-polige N und S System an das neue 15-polige System anzuschliessen oder umgekehrt.



PRISES & FICHES 24V 15 BROCHES ISO/DIS 12098

Applications: ces connecteurs sont utilisés pour la connexion électrique entre un véhicule tracteur et une remorque dans le secteur des véhicules commerciaux et industriels, avec installation électrique à 24 V.

Ce nouveau système regroupe en un seul connecteur toutes les connexions prévues dans l'ancien système à 24 V 7 broches type N et type S. Il se caractérise par une plus grande robustesse mécanique, par une meilleure étanchéité à l'eau et garantit une connexion électrique plus fiable et sûre. La fiche se raccorde à la prise avec un levier d'accrochage à encliquetage en acier. Ces caractéristiques répondent parfaitement aux particularités techniques imposées par la Normative ADR/GGVS pour des applications sur des véhicules destinés au transport de marchandises dangereuses.

Contacts en laiton nickelé, attaches arrière à ser-tir avec un outil approprié, ou à serre-fils (indiqués pour le marché des pièces de rechange).





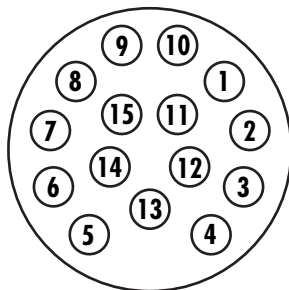





Des adaptateurs de différents types sont disponibles pour raccorder l'ancien système à 7 broches N et S avec le nouveau système à 13 broches ou vice-versa.

SCHEMA DI CONNESSIONE
CONTACTS ALLOCATION
KONTAKTBELEGUNG
AFFECTATION DES CONTACTS











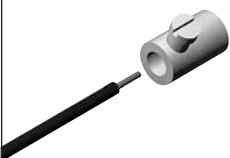

Connettori 15 poli 24V Norma ISO 12098 15 pins connectors 24V ISO 12098
15 polige Verbindungen 24V gemäß Norm ISO 12098 Connecteurs 15 pôles 24V Norme ISO 12098

Contatto n Contact no Kontakt Nr. Contact n	Funzione Function Funktion Fonction	Sezione Cavo Cable Diameter Kabeldurchmesser Couleur Câble	Colore cavo Colour Kabelfarbe Couleur câble
1	Indicatori di direzione SINISTRA Indicators LEFT Fahrtrichtungsanzeiger LINKS Indicateurs de direction GAUCHE	1,5 mm ²	Giallo Yellow Gelb Jaune
2	Indicatori di direzione DESTRA Indicators RIGHT Fahrtrichtungsanzeiger RECHTS Indicateurs de direction DROIT	1,5 mm ²	Verde Green Grün Vert
3	Luce retro-nebbia Rear fog light Nebelschlussleuchte Lumière feu de brouillard arrière	1,5 mm ²	Blu Blue Blau Bleu
4	Massa Earth Masse Masse	2,5 mm ²	Bianco White Weiss Blanc
5	Luce di posizione , luci di ingombro , illuminazione targa SINISTRA Side lights, end outmarker lights, numberplate light LEFT Schlussleuchten, Umriss-Begrenzungsleuchte, Kennzeichenleuchte LINKS Feux de position, feux d'encombrement, éclairage plaque GAUCHE	1,5 mm ²	Nero Black Schwarz Noir
6	Luce di posizione , luci di ingombro , illuminazione targa DESTRA Side lights, end outmarker lights, numberplate light RIGHT Schlussleuchten, Umriss-Begrenzungsleuchte, Kennzeichenleuchte RECHTS Feux de position, feux d'encombrement, éclairage plaque DROITE	1,5 mm ²	Marrone Brown Braun Marron
7	Luci di stop Brake lights Bremsleuchte Feux stop	1,5 mm ²	Rosso Red Rot Rouge
8	Luci di retromarcia Reverse lights Rückfahrleuchte Feux de marche arrière	1,5 mm ²	Rosa Pink Rosa Rose
9	Positivo di alimentazione diretto da batteria Positive direct from battery Pos. Stromspeisung direkt von Batterie Positif d'alimentation directe de batterie	2,5 mm ²	Arancio Orange Orange Orange
10	Sensore usura materiale d'attrito freni Brake wear sensor Sensor Bremsverschleiss Capteur usure matériau de frottement frein	1,5 mm ²	Grigio Grey Grau Gris
11	Sensore di pressione per freni ad accumulo di energia Pressure brakes and energy accumulation sensor Sensor Bremsdruck und Energieansammlung Capteur de pression pour freins à accumulation d'énergie	1,5 mm ²	Bianco/Nero White/Black Weiss/Schwarz Blanc/Noir
12	Collegamento per sollevamento terzo asse Connection for lifting 3rd axle Anschluss Hub dritte Achse Raccordement pour levage troisième axe	1,5 mm ²	Bianco/Blu White/Blue Weiss/Blau Blanc/Bleu
13	Massa di ritorno per linee trasmissione dati Return earth for data transmission lines Rückkehrmasse für Datentransmissionsleitungen Masse de retour pour lignes transmission données	2,5 mm ²	Bianco/Rosso White/Red Weiss/Rot Blanc/Rouge
14	Collegamento CANH CANH connection CANH Anschluss Raccordement CANH	1,5 mm ²	Bianco/Verde White/Green Weiss/Grün Blanc/Vert
15	Collegamento CANL CANL connection CANL Anschluss Raccordement CANL	1,5 mm ²	Bianco/Marrone White/Brown Weiss/Braun Blanc/Marron

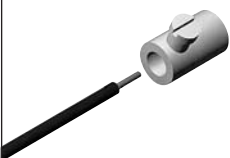
Uscita posteriore Cable outlet Kabelausgang Sortie postérieure	Norma Norm Norm Norme	Tipo contatti Type of contact Anschluss Type contacts	Sezione Contatti Pins section Querschnitt Kontakte Section Contacts	Diametro Cavo Cable diameter Kabeldurchmesser Diamètre Câble	Articolo Item no. Artikel-Nr. Article	Confezionamento Packaging Verpackung Emballage
 <p> 00 70 </p> <p>A vite Screw-on Schraubverriegelung A vis</p>			12x1,5 + 3x2,5 mm ²	Ø 15,5 mm	005848. 00	
				Ø 7/12 mm	005848. 70	
				Ø 15,5 mm	005842. 00	
				Ø 7/12 mm	005842. 70	
 <p> 00 70 </p> <p>A Baionetta Bayonet Bajonett-Verriegelung Baïonnette</p> 	ISO 12098 		12x1,5 + 3x2,5 mm ²	Ø 15,5 mm	005845. 00	
				Ø 7/12 mm	005845. 70	
				Ø 15,5 mm	005843. 00	
				Ø 7/12 mm	005843. 70	
 <p> 00 70 </p> <p>A Baionetta 90° Bayonet 90° Bajonett-Verriegelung 90° Baïonnette 90°</p> 			12x1,5 + 3x2,5 mm ²	Ø 15,5 mm	005846. 00	
				Ø 7/12 mm	005846. 70	
				Ø 15,5 mm	005844. 00	
				Ø 7/12 mm	005844. 70	
 <p> Presa 15 poli 24V parcheggio 15 pin 24V Parking Plug Park Steckdose 15-polig 24V Prise 15 pôles 24V de repos </p> 					005847. 00	

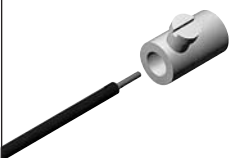
SPINE 24V 15 POLI 15 PINS PLUGS 24V 15-POLIGE STECKER 24V FICHES 24V 15 BROCHES

	Norma Norm Norm Norme	Tipo contatti Type of contact Anschluss Type contacts	Sezione Contatti Pins section Querschnitt Kontakte Section Contacts	Diametro Cavo Cable diameter Kabeldurchmesser Diamètre Câble	Articolo Item no. Artikel-Nr. Article	Confezionamento Packaging Verpackung Emballage
 	<p>ISO 12098</p> 		<p>12x1,5 + 3x2,5 mm²</p>	<p>Ø 15/17 mm</p>	<p>005945.00</p>	
			<p>Ø 11,5/14,5 mm</p>	<p>Ø 15/17 mm</p>	<p>005945.70</p>	
			<p>Ø 15/17 mm</p>	<p>Ø 15/17 mm</p>	<p>005946.00</p>	
			<p>Ø 11,5/14,5 mm</p>	<p>Ø 11,5/14,5 mm</p>	<p>005946.70</p>	



Descrizione
Description
Beschreibung
Description

Adattatore compatto spina 15 poli + 2 prese 7 poli N/S 24V
Compact Adapter from 15 pin plug to 2 socket 7 pin 24V N/S
Kompaktadapter von Stecker 15-polig auf 1 X N-Stecker 7-polig + 1 X S-Stecker 7-polig
Adaptateur compact Fiche 15 broches + 2 Prises 7 broches N/S

Articolo
Item no.
Artikel-Nr.
Article

005547.00



Adattatore Ultra-compacto Spina 15 poli+Presa 7P N/S
Ultra-compact Adapter from 15pin Plug to 2 X 7pin Socket S, N+S
Ultrakompakt-Adapter von Stecker 15P auf 1 x N-Steckdose 7-polig + 1 x S-Steckdose 7-polig
Adaptateur Ultra-compact Fiche 15 broches + Prise 7P N/S

Articolo
Item no.
Artikel-Nr.
Article

005602.00



SCHEMA DI COLLEGAMENTO WIRING DIAGRAM VERDRÄHTUNGSPLAN AFFECTATION DES CONTACTS

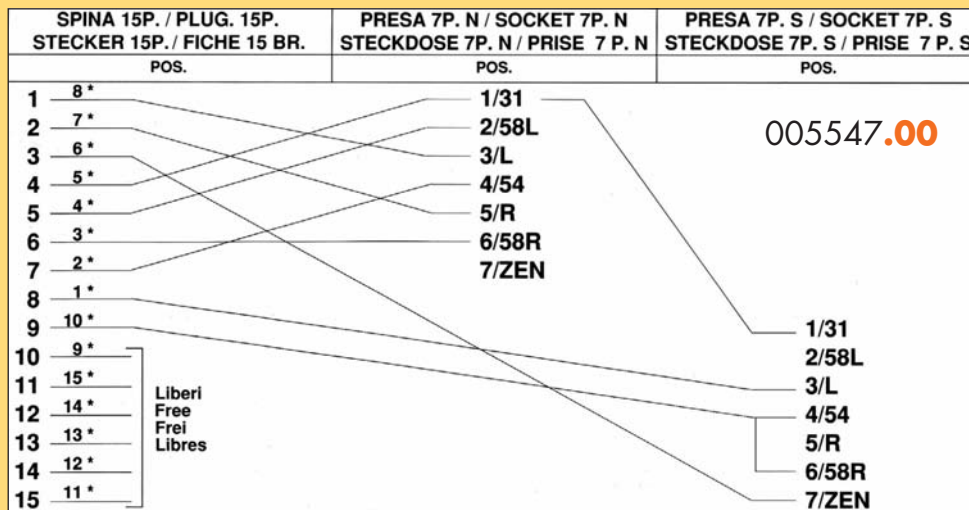

* numerazione sui cavi / * wires are numbered / * ader sind nummeriert / * cables intérieurs numérotés

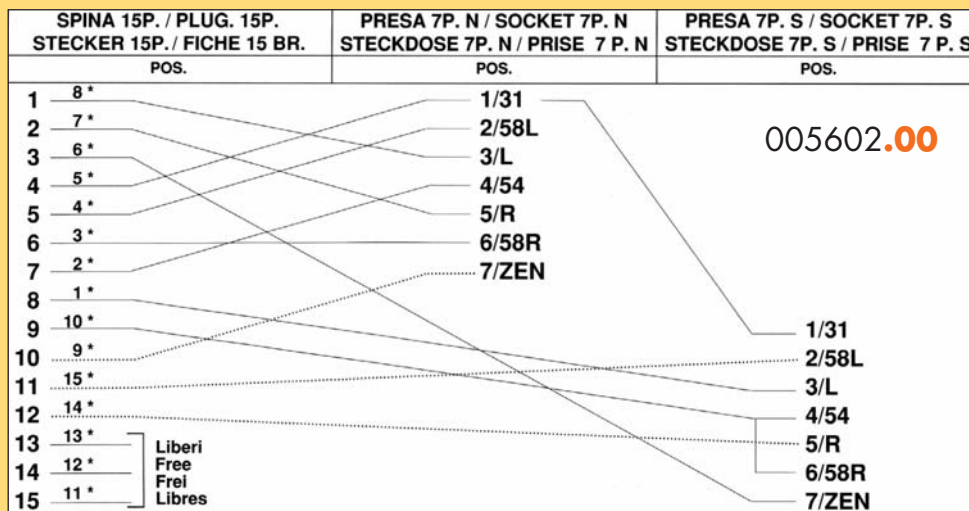

..... Collegamenti aggiunti non previsti dalla norma ISO 12098. / Additional connexions non required by the ISO 12098 standard.

Die zusätzlichen Verbindungen sind von der Normung ISO 12098 nicht vorgeschrieben. / Connexions supplémentaires non prévues par la norme ISO 12098.

	Descrizione Description Beschreibung Description	Articolo Item no. Artikel-Nr. Article	Confezionamento Packaging Verpackung Emballage
	<p>Adattatore bi-spirale spina 15 poli + 7p N/S LL 4,5m Adapter coil from 15 pin plug to 2 x 7 pin plugs, cable 4,5m Adapter Spiralkabel von Stecker 15-polig auf 1xN-Stecker 7-polig+1xS-Stecker 7-polig, 4,5m Kabel Adaptateur double spirale Fiche 15 broches + 7p N/S LL 4,5m</p> <p>HYTREL® (TEEE)</p>	<p>005557.00</p>	
	<p>Adattatore bi-spirale spina 15 poli + 7p N/S LL 3,5m Adapter coil from 15 pin plug to 2 x 7 pin plugs, cable 3,5m Adapter Spiralkabel von Stecker 15-polig auf 1xN-Stecker 7-polig+1xS-Stecker 7-polig, 3,5m Kabel Adaptateur double spirale Fiche 15 broches + 7p N/S LL 3,5m</p> <p>Poliuretano / Polyurethane / Poliurethan / Polyuréthane (TPU)</p>	<p>005557.70</p>	

SCHEMA DI COLLEGAMENTO WIRING DIAGRAM VERDRÄHTUNGSPLAN AFFECTATION DES CONTACTS

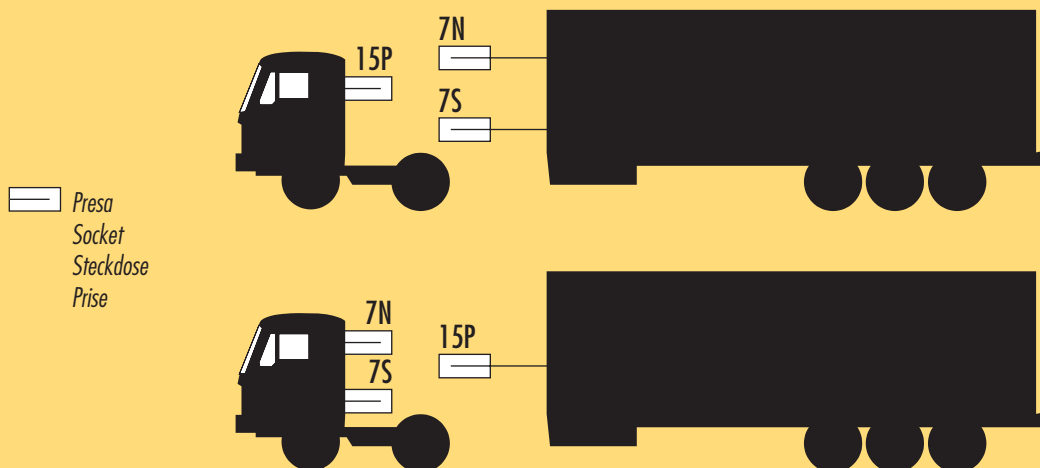

SPINA 15P. / PLUG. 15P. STECKER 15P. / FICHE 15 BR. POS.	SPINA 7P. N / PLUG. 7P. N STECKER 7P. N / FICHE 7 P. N POS.	SPINA 7P. S / PLUG. 7P. S STECKER 7P. S / FICHE 7 P. S POS.
1	1/31	
2	2/58L	
3	3/L	
4	4/54	
5	5/R	
6	6/58R	
7	7/ZEN	
8		1/31
9		2/58L
10		3/L
11		4/54
12		5/R
13		6/58R
14		7/ZEN
15		

13 — Liberi
 14 — Free
 15 — Frei
 15 — Libres

..... Collegamenti aggiunti non previsti dalla norma ISO 12098. / Additional connexions non required by the ISO 12098 standard.
 Die zusätzlichen Verbindungen sind von der Normung ISO 12098 nicht vorgeschrieben. / Connexions supplémentaires non prévues par la norme ISO 12098.



Descrizione
Description
Beschreibung
Description

Adattatore Presa 15 poli + 2 Spine 7 poli N/S
Adapter from 15P Socket to 2 X 7P Plug S N+S
Adapter von Steckdose 15-polig auf 1 x N-Stecker 7-polig + 1 x S-Stecker 7-polig
Adaptateur Prise 15 broches + Fiche 7P N/S

Articolo
Item no.
Artikel-Nr.
Article

005553.00

Confezionamento
Packaging
Verpackung
Emballage



SCHEMA DI COLLEGAMENTO WIRING DIAGRAM VERDRÄHTUNGSPLAN AFFECTATION DES CONTACTS

Presa
 Socket
 Steckdose
 Prise
 Spina
 Plug
 Stecker
 Fiche

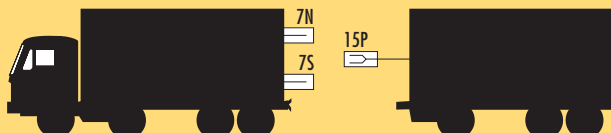

PRESA 15P. / SOCKET 15P. STECKDOSE 15P. / PRISE 15 BR.		SPINA 7P. N / PLUG. 7P. N STECKER 7P. N / FICHE 7 P. N		SPINA 7P. S / PLUG. 7P. S STECKER 7P. S / FICHE 7 P. S	
POS.		POS.		POS.	
1		1/31			
2		2/58L			
3		3/L			
4		4/54			
5		5/R			
6		6/58R			
7		7/ZEN			
8				1/31	
9				2/58L	
10				3/L	
11				4/54	
12				5/R	
13				6/58R	
14				7/ZEN	
15					
	Liberi Free Frei Libres				

Collegamenti aggiunti non previsti dalla norma ISO 12098. / Additional connexions not required by the ISO 12098 standard.
Die zusätzlichen Verbindungen sind von der Normung ISO 12098 nicht vorgeschrieben. / Connexions supplémentaires non prévues par la norme ISO 12098.



Adattatore Spina 15 poli + 2 prese 7 poli N/S
Adapter from 15 Plug to 2 Socket S 7 pin N/S, with 1 m cable
Adapter von 1 x N-Steckdose 7P + 1 x S-Steckdose 7P auf Stecker 15P, 1m Kabel
Adaptateur Fiche 15 broches + 2 Prises 7 broches N/S

005554.00



SCHEMA DI COLLEGAMENTO WIRING DIAGRAM VERDRÄHTUNGSPLAN AFFECTATION DES CONTACTS

Presa
 Socket
 Steckdose
 Prise
 Spina
 Plug
 Stecker
 Fiche

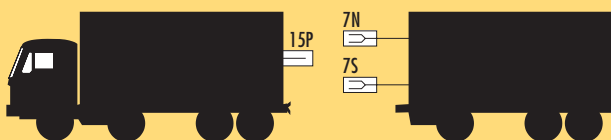

SPINA 15P. / PLUG. 15P. STECKER 15P. / FICHE 15 BR.		PRESA 7P. N / SOCKET 7P. N STECKDOSE 7P. N / PRISE 7 P. N		PRESA 7P. S / SOCKET 7P. S STECKDOSE 7P. S / PRISE 7 P. S	
POS.		POS.		POS.	
1	8*	1/31			
2	7*	2/58L			
3	6*	3/L			
4	5*	4/54			
5	4*	5/R			
6	3*	6/58R			
7	2*	7/ZEN			
8	1*			1/31	
9	10*			2/58L	
10	9*			3/L	
11	15*			4/54	
12	14*			5/R	
13	13*			6/58R	
14	12*			7/ZEN	
15	11*				
	Liberi Free Frei Libres				





* numerazione sui cavi / * wires are numbered / * ader sind nummeriert / * cables intérieurs numérotés

	Descrizione Description Beschreibung Description	Articolo Item no. Artikel-Nr. Article	Confezionamento Packaging Verpackung Emballage
	<p>Adattatore da presa 15 poli a presa 7 poli N. ed S. 24V senza connettore ausiliario Adapter from 15 pin socket to 24V 7 pin N + S sockets, without auxiliary connector Adapter von 15-poliger Steckdose auf 7-polige N+S Steckdosen 24V, ohne Zusatzanschluss Adaptateur de prise 15 broche à prises 7 broches N+S 24V, sans connecteur auxiliaire</p>	<p>005608.00</p>	
	<p>Adattatore da presa 15 poli a presa 7 poli N. ed S. 24V con connettore ausiliario Adapter from 15 pin socket to 24V 7 pin N + S sockets, with auxiliary connector Adapter von 15-poliger Steckdose auf 7-polige N+S Steckdosen 24V, mit Zusatzanschluss Adaptateur de prise 15 broche à prises 7 broches N+S 24V, avec connecteur auxiliaire</p>	<p>005608.60</p>	
	<p>Adattatore da presa 15 poli a presa 7 poli N. ed S. 24V con connettore ausiliario corredato di dado e pressacavo Adapter from 15 pin socket to 24V 7 pin N + S sockets, with auxiliary connector and PG16 nut with cable retainer Adapter von 15-poliger Steckdose auf 7-polige N+S Steckdosen 24V, mit Zusatzanschluss, Mutter PG16 und Kabelpresse Adaptateur de prise 15 broche à prises 7 broches N+S 24V, avec connecteur auxiliaire, écrou PG16 et presse-câble.</p>	<p>005608.61</p>	
	<p>Spina angolare 4 poli DIN 72585 4-Pole plug acc. DIN 72585 4 Poliger Winkel-Stecker DIN 72585 Fiche angulaire 4 broches DIN 72585</p>	<p>002268.00</p>	
	<p>Spina angolare 7 poli 7-Pole plug acc. 7 Poliger Winkel-Stecker Fiche angulaire 7 broches</p>	<p>002273.00</p>	
	<p>Coperchio a tenuta per connettori DIN 72585 Seal cap for DIN connectors 72585 Dichtungskappe für Steckverbinder DIN 72585 Couvercle étanche pour connecteurs DIN 72585</p>	<p>002278.00</p>	

	Descrizione Description Beschreibung Description	Articolo Item no. Artikel-Nr. Article	Confezionamento Packaging Verpackung Emballage
	Dado + guarnizione presa 15 poli (cavo Ø 15,5mm) Nut + rubber seal for 15 pin socket (cable Ø 15,5mm) Überwurfmutter + Klemmdichtring zu 15-polig Steckdosen (Kabel Ø 15,5mm) Écrou + joint Prise 15 broches (câble Ø 15,5mm)	006011.00	
	Dado + guarnizione presa 15 poli (cavo Ø 7/12mm) Nut + rubber seal for 15 pin socket (cable Ø 7/12mm) Überwurfmutter + Klemmdichtring zu 15-polig Steckdosen (Kabel Ø 7/12mm) Écrou + joint Prise 15 broches (câble Ø 7/12mm)	006050.00	
	Kit contatti presa 15 poli (12x1,5+3x2,5mm ²) Replacement set of pins for 15 pin socket (12x1,5+3x2,5mm ²) Ersatz-Set Crimpkontakte zu 15-polig Steckdose (12x1,5+3x2,5mm ²) Kit contacts Prise 15 broches (12x1,5+3x2,5mm ²)	006054.00	
	Kit contatti a vite presa 15 poli Replacement set of screw pins for 15pin socket Ersatz-Set Schraubkontakte zu Steckdose 15-polig Kit contacts a vis prise 15 broches	006048.00	
	Contatto maschio 1,5mm ² da crimpare per presa 15 poli Male crimp pins for 15 pin socket 1,5mm ² Kontaktstift zu 15-polig Steckdose, 1,5mm ² , Crimpanschluss Contact male 1,5mm ² Prise 15 broches	006017.62	
	Contatto maschio 2,5mm ² da crimpare per presa 15 poli Male crimp pins for 15 pin socket 2,5mm ² Kontaktstift zu 15-polig Steckdose, 2,5mm ² , Crimpanschluss Contact male 2,5mm ² Prise 15 broches	006025.00	
	Contatto maschio a vite corto per presa 15 poli Male screw pins (short type) for 15 pin socket Kontaktstift zu Steckdosen 15-polig , kurz , Schraubanschluss Contact male borne courte Prise 15 broches	006044.90	
	Contatto maschio a vite lungo per presa 15 poli Male screw pins (long type) for 15 pin socket Kontaktstift zu Steckdosen 15-polig , lang , Schraubanschluss Contact male borne longue Prise 15 broches	006048.90	
	Pinza per crimpatura contatti (15 poli) Hand Crimping tool for pins (15pin) Crimpzange für Kontakte (15-polig) Pince a crimper les contacts (15 broches)	079903.00	

	Descrizione Description Beschreibung Description	Articolo Item no. Artikel-Nr. Article	Confezionamento Packaging Verpackung Emballage
	Kit contatti spina 15 poli (12x1,5+3x2,5mm ²) Replacement set of pins for 15 pin plus (12x1,5+3x2,5mm ²) Ersatz-Set Crimpkontakte zu 15-polig Stecker (12x1,5+3x2,5mm ²) Kit contacts Fiche 15 broches (12x1,5+3x2,5mm ²)	006055.00	
	Kit contatti a vite spina 15 poli Replacement set of screw pins for 15pin plug Ersatz-Set Schraubkontakte zu Stecker 15-polig Kit contacts a vis fiche 15 broches	006049.00	
	Contatto femmina 1,5mm ² da crimpare per spina 15 poli Female crimp pins for 15 pin plug 1,5mm ² Kontakthülse zu 15-polig Stecker, 1,5mm ² , Crimpanschluss Contact femelle 1,5mm ² Fiche 15 broches	006019.60	
	Contatto femmina 2,5mm ² da crimpare per spina 15 poli Female crimp pins for 15 pin plug 2,5mm ² Kontakthülse zu 15-polig Stecker, 2,5mm ² , Crimpanschluss Contact femelle 2,5mm ² Fiche 15 broches	006028.00	
	Contatto femmina a vite corto per spina 15poli Female screw pins (short type) for 15pin plug Kontakthülse zu Steckern 15-polig, kurz, Schraubanschluss Contact femelle borne courte Fiche 15 broches	006046.90	
	Contatto femmina a vite lungo per spina 15poli Female screw pins (long type) for 15pin plug Kontakthülse zu Steckern 15-polig, lang, Schraubanschluss Contact femelle borne longue Fiche 15 broches	006049.90	

CAVI ADR ADR CABLES ADR KABEL CÂBLES ADR CAVI ADR ADR CABLES ADR KABEL CÂBLES ADR

	Materiale cavo Cable made of Kabelmaterial Matériel câble	Formazione cavo Section Querschnitt Formation câble	Sezione cavo Cable diameter Kabeldurchmesser Section câble	Lunghezza Length Länge Longueur	Articolo Item no. Artikel-Nr. Article	Confezionamento Packaging Verpackung Emballage
	Poliuretano Polyurethane Poliurethan Polyuréthane (TPU) ISO 4141 ISO 6722	3x2,5+10x1,5 +1x(2x1,5) mm ²	Ø 15,5 mm	50 m	002012.00	
				500 m	002013.00	

Colore cavi, vedi pag. 59.
Cables colour, see the page 59.

Aderfarbe, siehe seite 59.
Couleur des câbles, voir la page 59.



ISO 4141

SPIRALI E CABLAGGI 24V 15 POLI

**15 PINS COILS AND WIRING 24V
15-POLIGE SPIRALKABEL UND VERBINDUNGSKABEL 24V
CORDONS ET CABLAGES 24V 15 BROCHES**

6



SPIRALI E CABLAGGI 24V 15 POLI ISO 4141

Applicazioni: Le spirali elettriche con spine 15 poli 24V vengono utilizzate per effettuare il collegamento elettrico tra una motrice ed un semirimorchio nel settore dei veicoli commerciali ed industriali, conformemente alle normative ISO/DIS 12098. Il loro impiego è particolarmente indicato per il collegamento elettrico su veicoli adibiti al trasporto di merci pericolose, in base alle specifiche tecniche dettate dalla Normativa ADR/GGVS.

Questi prodotti vengono realizzati con un cavo conforme alla normativa ISO 4141 con guaina esterna in HYTREL® (TEEE) o in TPU (Poliuretano).

L'HYTREL (TEEE) ha ottime caratteristiche di elasticità e di robustezza meccanica e resistenza agli aggressivi chimici; è il materiale preferito per forniture di 1° impianto. È disponibile in due versioni: con un diametro di spira di 80 mm. e di 40 mm., con lunghezza di lavoro da 3,5 a 4,5 m.

Il TPU (Poliuretano) è caratterizzato da una maggiore morbidezza ed elasticità anche alle basse temperature. È realizzato in un'unica versione: lunghezza massima estensibile 4m. e diametro spira 30 mm. che riduce sensibilmente l'ingombro creato dai numerosi collegamenti tra motrice e rimorchio. Queste caratteristiche lo rendono particolarmente apprezzato dal mercato dell'aftermarket.

Sono disponibili anche cablaggi per rimorchi con presa o con spina a 15 poli, di lunghezza da 6 a 12m., realizzati sia con cavo ADR che con guaina corrugata ADR in PA6.



15 PINS COILS AND WIRING 24V ISO 4141

Use: the 24V electrical coils with 15 p plug are used to connect a truck tractor and a semitrailer in the commercial vehicles sector, conforming to ISO/DIS 12098. They are particularly suited for electrical connections on vehicles transporting hazardous goods, based on the technical specifications given by ADR/GGVS norms.

These products are supplied with cable conforming to ISO 4141; and external sheath made of HYTREL® (TEEE) or of POLYURETHANE (TPU).

HYTREL® (TEEE) has excellent qualities as regards elasticity and mechanical resistance as well as resistance against chemical agents and is used preferably by OEM's. Two versions are available: with 80 mm and 40 mm turn diameter, and working lengths of 3,5 and 4,5 m.

POLYURETHANE (TPU) maintains greater smoothness and elasticity even at low temperatures. The version produced has 4 m maximum extensible length and 30 mm turn diameter thus minimizing the space taken by the numerous connections between vehicle and trailer. Thanks to these characteristics it is particularly used in the aftermarket.

Furthermore, cables for trailers with 15 p socket or plug are available; lengths from 6 m to 12m., both with ADR cable and ADR conduit made of PA6.



15-POLIGE SPIRALKABEL UND VERBINDUNGSKABEL 24V ISO 4141

Anwendung: die elektrischen Spiralkabel mit 15-poligen 24V Steckern sind zum elektrischen Anschluss zwischen einem Zugfahrzeug und einem Anhänger im Bereich Nutzfahrzeuge bestimmt und entsprechen ISO/DIS 12098. Besonders geeignet für elektrische Verbindungen für Gefahrgutfahrzeuge, basierend auf den technischen Spezifikationen der ADR/GGVS Norm.

Die Produktion erfolgt mit einem ISO 4141 entsprechenden Kabel mit äußerer Ummantelung aus HYTREL® (TEEE) oder Polyurethan(TPU).

HYTREL® (TEEE) ist in hohem Maße elastisch und widerstandsfähig - auch gegen chemische Stoffen und Abnutzung - und wird bei der Fertigung als Material vorgezogen. Erhältlich sind 2 Ausführungen: mit 80 mm und 40 mm Windungsdurchmesser sowie Arbeitslängen von 3,5 bis 4,5 m.

POLYURETHAN (TPU) dagegen bleibt auch bei niedrigeren Temperaturen weich und elastisch. Verfügbar ist eine Ausführung von max 4 m Längenausdehnung und nur 30 mm Windungsdurchmesser, der dazu beiträgt, den Umfang der zahlreichen Verbindungen zwischen Zugfahrzeug und Anhänger zu reduzieren. Dank dieser Charakteristika ist das Produkt besonders für den Ersatzteilmarkt attraktiv.

Verfügbar sind auch Kabel für Anhänger mit 15-poliger Steckdose oder Stecker, Längen von 6 bis 12 m, mit ADR Kabel oder ADR Wellrohr aus PA6.



CORDONS ET CABLAGES 24V 15 BROCHES ISO 4141

Applications: Les cordons électriques avec fiches 15 broches 24 V sont utilisées pour effectuer la connexion électrique entre un véhicule tracteur et une semi-remorque dans le secteur des véhicules commerciaux et industriels conformément à la normative ISO/DIS 12098. Leur utilisation est particulièrement indiquée pour la connexion électrique sur des véhicules destinés au transport de marchandises dangereuses, en fonctions des particularités techniques imposées par la Normative ADR/GGVS.

Ces produits sont réalisés avec un câble conforme à la normative ISO 4141 avec une gaine extérieure en HYTREL® (TEEE) ou en POLYURÉTHANE(TPU).

Le HYTREL® (TEEE) a d'excellentes caractéristiques d'élasticité et de robustesse mécanique, de résistance à l'agressivité chimique et à l'abrasion; c'est le matériau préféré pour la fourniture de 1^o installation. C'est disponible en deux versions: avec un diamètre de spire de 80 mm et de 40 mm avec une longueur de travail de 3,5 à 4,5 m.

Le POLYURÉTHANE (TPU) se caractérise au contraire par une plus grande souplesse et élasticité même à de basses températures. C'est réalisé dans une seule version: longueur maximale extensible 4 m et diamètre de spire de 30 mm qui réduit sensiblement l'encombrement créé par les nombreuses connexions existant entre le véhicule tracteur et la remorque. Ces caractéristiques le rendent particulièrement apprécié par le marché de l'after-market.

Des câblages pour remorques avec prise ou avec fiche 15 broches, de longueur de 6 à 12 m, réalisés aussi bien avec câble ADR qu'avec gaine gouffrée ADR en PA6.

SCHEMA DI CONNESSIONE
CONTACTS ALLOCATION
KONTAKTBELEGUNG
AFFECTATION DES CONTACTS

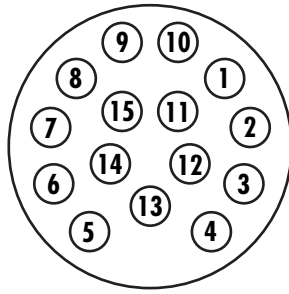















Connettori 15 poli 24V Norma ISO 12098 15 pins connectors 24V ISO 12098
15 polige Verbindungen 24V gemäß Norm ISO 12098 Connecteurs 15 pôles 24V Norme ISO 12098

Contacto n Contact no Kontakt Nr. Contact n	Funzione Function Funktion Fonction	Sezione Cavo Cable Diameter Kabeldurchmesser Couleur Câble	Colore cavo Colour Kabelfarbe Couleur câble
1	Indicatori di direzione SINISTRA Indicators LEFT Fahrtrichtungsanzeiger LINKS Indicateurs de direction GAUCHE	1,5 mm ²	Giallo Yellow Gelb Jaune
2	Indicatori di direzione DESTRA Indicators RIGHT Fahrtrichtungsanzeiger RECHTS Indicateurs de direction DROIT	1,5 mm ²	Verde Green Grün Vert
3	Luce retro-nebbia Rear fog light Nebelschlussleuchte Lumière feu de brouillard arrière	1,5 mm ²	Blu Blue Blau Bleu
4	Massa Earth Masse Masse	2,5 mm ²	Bianco White Weiss Blanc
5	Luce di posizione , luci di ingombro , illuminazione targa SINISTRA Side lights, end outmarker lights, numberplate light LEFT Schlussleuchten, Umriss-Begrenzungsleuchte, Kennzeichenleuchte LINKS Feux de position, feux d'encombrement, éclairage plaque GAUCHE	1,5 mm ²	Nero Black Schwarz Noir
6	Luce di posizione , luci di ingombro , illuminazione targa DESTRA Side lights, end outmarker lights, numberplate light RIGHT Schlussleuchten, Umriss-Begrenzungsleuchte, Kennzeichenleuchte RECHTS Feux de position, feux d'encombrement, éclairage plaque DROITE	1,5 mm ²	Marrone Brown Braun Marron
7	Luci di stop Brake lights Bremsleuchte Feux stop	1,5 mm ²	Rosso Red Rot Rouge
8	Luci di retromarcia Reverse lights Rückfahrleuchte Feux de marche arrière	1,5 mm ²	Rosa Pink Rosa Rose
9	Positivo di alimentazione diretto da batteria Positive direct from battery Pos. Stromspeisung direkt von Batterie Positif d'alimentation directe de batterie	2,5 mm ²	Arancio Orange Orange Orange
10	Sensore usura materiale d'attrito freni Brake wear sensor Sensor Bremsverschleiss Capteur usure matériau de frottement frein	1,5 mm ²	Grigio Grey Grau Gris
11	Sensore di pressione per freni ad accumulo di energia Pressure brakes and energy accumulation sensor Sensor Bremsdruck und Energieansammlung Capteur de pression pour freins à accumulation d'énergie	1,5 mm ²	Bianco/Nero White/Black Weiss/Schwarz Blanc/Noir
12	Collegamento per sollevamento terzo asse Connection for lifting 3rd axle Anschluss Hub dritte Achse Raccordement pour levage troisième axe	1,5 mm ²	Bianco/Blu White/Blue Weiss/Blau Blanc/Bleu
13	Massa di ritorno per linee trasmissione dati Return earth for data transmission lines Rückkehrmasse für Datentransmissionsleitungen Masse de retour pour lignes transmission données	2,5 mm ²	Bianco/Rosso White/Red Weiss/Rot Blanc/Rouge
14	Collegamento CANH CANH connection CANH Anschluss Raccordement CANH	1,5 mm ²	Bianco/Verde White/Green Weiss/Grün Blanc/Vert
15	Collegamento CANL CANL connection CANL Anschluss Raccordement CANL	1,5 mm ²	Bianco/Marrone White/Brown Weiss/Braun Blanc/Marron

	Materiale cavo Cable made of Kabelmaterial Matériel câble	Formazione cavo Section Querschnitt Formation câble	Sezione cavo Cable diameter Kabeldurchmesser Section câble	Diametro spira Turn diameter Windungsdurchmesser Diamètre spirale	Numero spire Number of turns Windungszahl Nombre spirales	
	HYTREL® (TEEE) ISO 4141	12x1,5+3x2,5 mm ²	Ø 13,5 mm	Ø 80 mm	14	
				Ø 80 mm	19	
	HYTREL® (TEEE) ISO 4141	12x1,5+3x2,5 mm ²	Ø 13,5 mm	Ø 40 mm	23,5	
				Ø 40 mm	30,5	
	Poliuretano Polyurethane Poliurethan Polyuréthane (TPU) ISO 4141	12x1,5+3x2,5 mm ²	Ø 15 mm	Ø 30 mm	35,5	
						

SPIRALI 24V 15 POLI 15 PINS COILS 24V 15-POLIGE SPIRALKABEL 24V CORDONS ÉLECTRIQUES 24V 15 BROCHES

L.L. Max. estensibile Max. extendable W.L. Max. ausziehbare A.L. Max. extensible L.T.	Norma Norm Norm Norme	Descrizione Description Beschreibung Description	Articolo Item no. Artikel-Nr. Article	Confezionamento Packaging Verpackung Emballage	Accessori Accessories Zubehör Accessoires
3,5 m	ISO 12098	Senza spine Without Plugs Ohne Stecker Sans Fiches	005591. 71		Manicotto in gomma Rubber cable guard Knickschutztülle Manchon en caoutchouc
4,5 m		Spine 15 poli 24V 15 pin 24V plugs Steckern 15-polig 24V Fiches 15 broches 24V	005590. 71		
3,5 m	ISO 12098	Senza spine Without Plugs Ohne Stecker Sans Fiches	005591. 70		Manicotto in gomma Rubber cable guard Knickschutztülle Manchon en caoutchouc
4,5 m		Spine 15 poli 24V 15 pin 24V plugs Steckern 15-polig 24V Fiches 15 broches 24V	005590. 70		
3,5 m	ISO 12098	Senza spine Without Plugs Ohne Stecker Sans Fiches	005596. 71		Manicotto in gomma Rubber cable guard Knickschutztülle Manchon en caoutchouc
4,5 m		Spine 15 poli 24V 15 pin 24V plugs Steckern 15-polig 24V Fiches 15 broches 24V	005595. 71		
3,5 m	ISO 12098	Senza spine Without Plugs Ohne Stecker Sans Fiches	005596. 70		Manicotto in gomma Rubber cable guard Knickschutztülle Manchon en caoutchouc
4,5 m		Spine 15 poli 24V 15 pin 24V plugs Steckern 15-polig 24V Fiches 15 broches 24V	005595. 70		
4 m	ISO 12098	Senza spine Without Plugs Ohne Stecker Sans Fiches	005596. 80		Manicotto in gomma Rubber cable guard Knickschutztülle Manchon en caoutchouc
	Spine 15 poli 24V 15 pin 24V plugs Steckern 15-polig 24V Fiches 15 broches 24V	005596. 85			



7



ISO 7638-1 / ISO7638-2

PRESE & SPINE ABS/EBS 12/24V

SOCKETS & PLUGS ABS/EBS 12/24V

STECKDOSEN & STECKER ABS/EBS 12/24V

PRISES & FICHES ABS/EBS 12/24V





PRESE & SPINE ABS/EBS 12/24V ISO 7638-1 / ISO7638-2

Applicazioni: questi connettori sono utilizzati per il collegamento elettrico del sistema frenante ABS/EBS tra un veicolo trainante ed un rimorchio/semirimorchio nel settore dei veicoli Industriali, in versione per impianto elettrico a 24V. o a 12V.

Il sistema ABS /EBS, conformemente alle normative ISO/DIN 7638, è obbligatorio su veicoli che superino le 3,5 ton.

Le caratteristiche tecniche dei materiali impiegati sono conformi alle specifiche dettate dalla Normativa ADR/GGVS per l'allestimento di veicoli adibiti al trasporto di merci pericolose.

I connettori sono disponibili in versione a 5 poli per impianto frenante ABS e in versione a 7poli per impianto frenante EBS. Il sistema EBS ha due contatti in più per effettuare lo scambio di dati tra la centralina della motrice e quella del rimorchio, allo scopo di ottimizzare la frenatura.

Le spine si collegano alle prese mediante una leva di aggancio anti-sfilamento in acciaio. Le prese sono dotate di un sistema di espulsione della spina se questa non è inserita correttamente. Le caratteristiche di robustezza meccanica e impermeabilità all'acqua garantiscono un collegamento elettrico efficiente ed affidabile.



SOCKETS & PLUGS ABS/EBS 12/24V ISO 7638-1 / ISO7638-2

Use: these connectors are used for the electrical connection of the ABS/EBS braking system between a truck tractor and a trailer or semitrailer in the commercial vehicles sector, both for 24V and 12V electrical systems.

The ABS/EBS system conforming to ISO/DIN 7638 is compulsory on all vehicles weighing over 3,5 tons.

The technical specifications of the materials used conform to ADR/GGVS norm requirements for vehicles transporting hazardous goods.

The connectors are available in a 5p version for the ABS and in a 7p version for the EBS braking system. EBS requires two additional contacts in order to permit the exchange of data between cab and trailer, so as to optimize the braking effect.

The plugs are connected to the sockets with a steel bracket in order to avoid accidental disconnection. The sockets are provided with an expulsion system of the plug in case the latter is not plugged in correctly. Mechanical resistance and watertightness guarantee an efficient and reliable electrical connection.



STECKDOSEN & STECKER ABS/EBS 12/24V ISO 7638-1 / ISO7638-2

Anwendung: diese Verbindungen werden für den elektrischen Anschluss des ABS/EBS Bremssystems zwischen einem Zugfahrzeug und einem Anhänger im Bereich Nutzfahrzeuge verwendet, mit 24V oder 12V Schaltung. ABS/EBS Bremssysteme sind gemäß ISO/DIN 7638 für Fahrzeuge über 3,5 Tonnen Pflicht.

Die technischen Eigenschaften der verwendeten Materialien entsprechen den Erfordernissen der ADR/GGVS Norm für Fahrzeuge die Gefahrgut transportieren.

Verfügbar sind eine 5-polige Ausführung für ABS Bremssysteme und eine 7-polige für EBS Bremssysteme. Das EBS System benötigt zur Optimierung des Bremsvorgangs zwei zusätzliche Kontakte zum Austausch der Daten zwischen der Schalttafel des Zugfahrzeugs und der des Anhängers.

Die Stecker verbinden sich mit den Steckdosen mittels einer Verriegelung aus Stahl. Die Steckdosen verfügen über ein Auswurfsystem des Steckers wenn dieser nicht vorschriftsmäßig eingesetzt wird. Mechanischer Widerstand und Wasserfestigkeit garantieren einen zuverlässigen und sicheren Anschluss.



PRISES & FICHES ABS/EBS 12/24V ISO 7638-1 / ISO7638-2

Applications: ces connecteurs sont utilisés pour la connexion électrique du système ABS/EBS entre un véhicule tracteur et une remorque / semi-remorque dans le secteur des véhicules industriels, en version pour installation électrique à 24V ou à 12 V.

Le système ABS/EBS, conformément à la normative ISO/DIN 7638, est obligatoire pour les véhicules dépassant les 3,5 t.

Les caractéristiques techniques des matériaux employés sont conformes aux spécificités imposées par la Normative ADR/GGVS pour l'équipement de véhicules destinés au transport de marchandises dangereuses.

Les connecteurs sont disponibles en version à 5 broches pour système de freinage ABS et en version à 7 broches pour système de freinage EBS. Le système EBS a deux contacts en plus pour effectuer le changement de données entre la centrale du véhicule tracteur et la centrale de la remorque afin d'optimiser le freinage.

Les fiches se raccordent aux prises avec un levier d'accrochage à encliquetage en acier. Les prises sont douées d'un système d'expulsion de la fiche si cette dernière n'est pas correctement introduite. Les caractéristiques de robustesse mécanique et d'étanchéité à l'eau garantissent une connexion électrique efficace et fiable.

SCHEMA DI CONNESSIONE
CONTACTS ALLOCATION
KONTAKTBELEGUNG
AFFECTATION DES CONTACTS

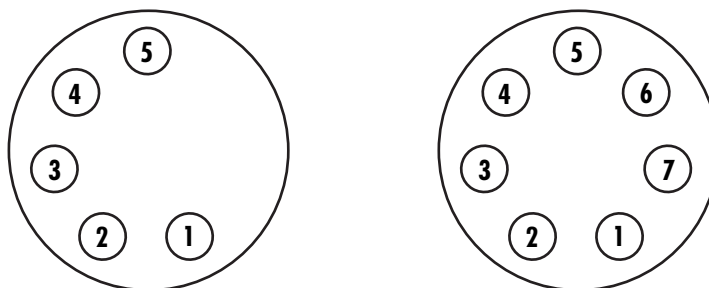















Collegamenti prese spine ABS 24V e 12V 24V and 12V ABS sockets and plugs connections
Verbindungen STECKDOSEN STECKER ABS 24V UND 12V Connexions prises fiches ABS 24V et 12V







Contacto n Contact no Kontakt Nr. Contact n	Funzione Function Funktion Fonction	Sezione Cavo Cable Diameter Kabeldurchmesser Couleur Câble	Colore cavo Colour Kabelfarbe Couleur câble
1	Positivo alimentazione elettrovalvole Positive electrovalves Pos. Stromspeisung Elektroventile Positif alimentation électrovannes	4 o 6 mm ²	Rosso Red Rot Rouge
2	Positivo collegamenti elettronici Positive electronic connections Pos. elektronische Anschlussverbindungen Positif connexions électroniques	1,5 mm ²	Nero Black Schwarz Noir
3	Negativo collegamenti elettronici Negative electronic connections Neg. elektronische Anschlüsse Négatif connexions électroniques	1,5 mm ²	Giallo Yellow Gelb Jaune
4	Negativo alimentazione elettrovalvole Negative electrovalves Neg. Anschluss Elektroventile Négatif alimentation électrovannes	4 o 6 mm ²	Marrone Brown Braun Marron
5	Collegamento lampada spia Warning light connection Anschluss Warnlicht Connexion lampe témoin	1,5 mm ²	Bianco White Weiss Blanc





















Collegamenti prese spine EBS 24V e 12V 24V and 12V EBS sockets and plugs connections
Verbindungen STECKDOSEN STECKER EBS 24V und 12V Connexions prises fiches EBS 24V et 12V







1	Positivo alimentazione elettrovalvole Positive electrovalves Pos. Stromspeisung Elektroventile Positif alimentation électrovannes	4 o 6 mm ²	Rosso Red Rot Rouge
2	Positivo collegamenti elettronici Positive electronic connections Pos. elektronische Anschlussverbindungen Positif connexions électroniques	1,5 mm ²	Nero Black Schwarz Noir
3	Negativo collegamenti elettronici Negative electronic connections Neg. elektronische Anschlüsse Négatif connexions électroniques	1,5 mm ²	Giallo Yellow Gelb Jaune
4	Negativo alimentazione elettrovalvole Negative electrovalves Neg. Anschluss Elektroventile Négatif alimentation électrovannes	4 o 6 mm ²	Marrone Brown Braun Marron
5	Collegamento lampada spia Warning light connection Anschluss Warnlicht Connexion lampe témoin	1,5 mm ²	Bianco White Weiss Blanc
6	Collegamento CANH CANH connection CANH Anschluss Connexion CANH	1,5 mm ²	Bianco/Verde White/Green Weiss/Grün Blanc/Vert
7	Collegamento CANL CANL connection CANL Anschluss Connexion CANL	1,5 mm ²	Bianco/Marrone White/Brown Weiss/Braun Blanc/Marron











Uscita posteriore Cable outlet Kabelausgang Sortie postérieure	Norma Norm Norm Norme	Tipo contatti Type of contact Anschluss Type contacts	Sezione Contatti Pins section Querschnitt Kontakte Section Contacts	Diametro Cavo Cable diameter Kabeldurchmesser Diamètre Câble	Articolo Item no. Artikel-Nr. Article	Confezionamento Packaging Verpackung Emballage			
 <p> -----.00 -----.70 </p> <p> <i>A vite</i> <i>Screw-on</i> <i>Schraubverriegelung</i> <i>A vis</i> </p>	ABS 12V		2x6 + 3x1,5 mm ²	Ø 15,5 mm	004202. 00				
 <p> -----.00 -----.70 </p> <p> <i>A Baionetta</i> <i>Bayonet</i> <i>Bajonett-Verriegelung</i> <i>Baïonnette</i> </p>		ISO 7638-2 		2x6 + 3x1,5 mm ²	Ø 15,5 mm	004205. 00			
 <p> -----.00 -----.70 </p> <p> <i>A Baionetta 90°</i> <i>Bayonet 90°</i> <i>Bajonett-Verriegelung 90°</i> <i>Baïonnette 90°</i> </p>					2x6 + 3x1,5 mm ²	Ø 15,5 mm	004208. 00		
							Ø 15,5 mm	004252. 00	
							Ø 7/12 mm	004250. 00	
							Ø 7/12 mm	004250. 70	







SPINE ABS 12V PLUGS ABS 12V STECKER ABS 12V FICHES ABS 12V

	Norma Norm Norm Norme	Tipo contatti Type of contact Anschluss Type contacts	Sezione Contatti Pins section Querschnitt Kontakte Section Contacts	Diametro Cavo Cable diameter Kabeldurchmesser Diamètre Câble	Articolo Item no. Artikel-Nr. Article	Confezionamento Packaging Verpackung Emballage
	<p>ABS 12V</p> <p>ISO 7638-2</p> 		<p>2x6 + 3x1,5 mm²</p>	<p>Ø 15/17 mm</p>	<p>005205.00</p>	
				<p>Ø 15/17 mm</p>	<p>005206.00</p>	
				<p>Ø 11,5/14,5 mm</p>	<p>005206.70</p>	









Uscita posteriore Cable outlet Kabelausgang Sortie postérieure	Norma Norm Norm Norme	Tipo contatti Type of contact Anschluss Type contacts	Sezione Contatti Pins section Querschnitt Kontakte Section Contacts	Diametro Cavo Cable diameter Kabeldurchmesser Diamètre Câble	Articolo Item no. Artikel-Nr. Article	Confezionamento Packaging Verpackung Emballage			
 <p> 00 70 </p> <p> A vite Screw-on Schraubverriegelung A vis </p>	EBS 12V		2x6 + 5x1,5 mm ²	Ø 15,5 mm	004203. 00				
 <p> 00 70 </p> <p> A Baionetta Bayonet Bajonett-Verriegelung Baïonnette </p>		ISO 7638-2 		2x6 + 5x1,5 mm ²	Ø 15,5 mm	004207. 00			
 <p> 00 70 </p> <p> A Baionetta 90° Bayonet 90° Bajonett-Verriegelung 90° Baïonnette 90° </p>					2x6 + 5x1,5 mm ²	Ø 15,5 mm	004209. 00		
							Ø 15,5 mm	004253. 00	
							Ø 15,5 mm	004253. 70	
							Ø 15,5 mm	004254. 00	
						Ø 7/12 mm	004254. 70		

	Norma Norm Norm Norme	Tipo contatti Type of contact Anschluss Type contacts	Sezione Contatti Pins section Querschnitt Kontakte Section Contacts	Diametro Cavo Cable diameter Kabeldurchmesser Diamètre Câble	Articolo Item no. Artikel-Nr. Article	Confezionamento Packaging Verpackung Emballage
	<p>EBS 12V</p> <p>ISO 7638-2</p> 		<p>2x6 + 5x1,5 mm²</p>	<p>Ø 15/17 mm</p>	<p>005207.00</p>	
				<p>Ø 15/17 mm</p>	<p>005208.00</p>	
				<p>Ø 11,5/14,5 mm</p>	<p>005208.70</p>	





Uscita posteriore Cable outlet Kabelausgang Sortie postérieure	Norma Norm Norm Norme	Tipo contatti Type of contact Anschluss Type contacts	Sezione Contatti Pins section Querschnitt Kontakte Section Contacts	Diametro Cavo Cable diameter Kabeldurchmesser Diamètre Câble	Articolo Item no. Artikel-Nr. Article	Confezionamento Packaging Verpackung Emballage
 00 70 A vite Screw-on Schraubverriegelung A vis	ABS 24V		2x6 + 3x1,5 mm ²	∅ 15,5 mm	005855. 00	
			2x4 + 3x1,5 mm ²	∅ 7/12 mm	005855. 70	
			∅ 15,5 mm	005836. 00		
			∅ 7/12 mm	005836. 70		
 00 70 A Baionetta Bayonet Bajonett-Verriegelung Baïonnette	ISO 7638-1 		2x6 + 3x1,5 mm ²	∅ 15,5 mm	005858. 00	
			2x4 + 3x1,5 mm ²	∅ 7/12 mm	005858. 70	
			∅ 15,5 mm	005837. 00		
			∅ 7/12 mm	005837. 70		
 00 70 A Baionetta 90° Bayonet 90° Bajonett-Verriegelung 90° Baïonnette 90°			2x6 + 3x1,5 mm ²	∅ 15,5 mm	005868. 00	
			2x4 + 3x1,5 mm ²	∅ 7/12 mm	005868. 70	
			∅ 15,5 mm	005838. 00		
			∅ 7/12 mm	005838. 70		

	Norma Norm Norm Norme	Tipo contatti Type of contact Anschluss Type contacts	Sezione Contatti Pins section Querschnitt Kontakte Section Contacts	Diametro Cavo Cable diameter Kabeldurchmesser Diamètre Câble	Articolo Item no. Artikel-Nr. Article	Confezionamento Packaging Verpackung Emballage
	<p>ABS 24V</p> <p>ISO 7638-1</p> 		<p>2x6 + 3x1,5 mm²</p>	<p>∅ 15/17 mm</p>	<p>005953.00</p>	
			<p>2x4 + 3x1,5 mm²</p>	<p>∅ 11,5/14,5 mm</p>	<p>005953.70</p>	
				<p>∅ 15/17 mm</p>	<p>005947.00</p>	
				<p>∅ 11,5/14,5 mm</p>	<p>005947.70</p>	

Uscita posteriore Cable outlet Kabelausgang Sortie postérieure	Norma Norm Norm Norme	Tipo contatti Type of contact Anschluss Type contacts	Sezione Contatti Pins section Querschnitt Kontakte Section Contacts	Diametro Cavo Cable diameter Kabeldurchmesser Diamètre Câble	Articolo Item no. Artikel-Nr. Article	Confezionamento Packaging Verpackung Emballage
 <p> 00 70 </p> <p>A vite Screw-on Schraubverriegelung A vis</p>	EBS 24V		2x6 + 5x1,5 mm ²	∅ 15,5 mm	005857. 00	
			2x4 + 5x1,5 mm ²	∅ 7/12 mm	005857. 70	
				∅ 15,5 mm	005839. 00	
				∅ 7/12 mm	005839. 70	
 <p> 00 70 </p> <p>A Baionetta Bayonet Bajonett-Verriegelung Baïonnette</p>	ISO 7638-1 		2x6 + 5x1,5 mm ²	∅ 15,5 mm	005859. 00	
			2x4 + 5x1,5 mm ²	∅ 7/12 mm	005859. 70	
				∅ 15,5 mm	005840. 00	
				∅ 7/12 mm	005840. 70	
 <p> 00 70 </p> <p>A Baionetta 90° Bayonet 90° Bajonett-Verriegelung 90° Baïonnette 90°</p>			2x6 + 5x1,5 mm ²	∅ 15,5 mm	005869. 00	
			2x4 + 5x1,5 mm ²	∅ 7/12 mm	005869. 70	
				∅ 15,5 mm	005841. 00	
				∅ 7/12 mm	005841. 70	

Norma Norm Norm Norme	Tipo contatti Type of contact Anschluss Type contacts	Sezione Contatti Pins section Querschnitt Kontakte Section Contacts	Diametro Cavo Cable diameter Kabeldurchmesser Diamètre Câble	Articolo Item no. Artikel-Nr. Article	Confezionamento Packaging Verpackung Emballage
 <p>EBS 24V</p> <p>ISO 7638-1</p> 		2x6 + 5x1,5 mm ²	∅ 15/17 mm	005957. 00	
		2x4 + 5x1,5 mm ²	∅ 11,5/14,5 mm	005957. 70	
		∅ 15/17 mm	005948. 00		
		∅ 11,5/14,5 mm	005948. 70		

PRESE ABS/EBS SOCKETS ABS/EBS STECKDOSEN ABS/EBS PRISES ABS/EBS

	Norma Norm Norm Norme	Tipo contatti Type of contact Anschluss Type contacts	Sezione Contatti Pins section Querschnitt Kontakte Section Contacts	Diametro Cavo Cable diameter Kabeldurchmesser Diamètre Câble	Articolo Item no. Artikel-Nr. Article	Confezionamento Packaging Verpackung Emballage
 <p>Presà ABS/EBS 12V di parcheggio 12V ABS/EBS Parking Socket ABS/EBS Park-Steckdose 12V Prise ABS/EBS 12V de repos</p>					004206.00	
 <p>Presà ABS/EBS 24V di parcheggio 24V ABS/EBS Parking Socket ABS/EBS Park-Steckdose 24V Prise ABS/EBS 24V de repos</p>					005856.00	

CAVI ADR ADR CABLES ADR KABEL CÂBLES ADR CAVI ADR ADR CABLES ADR KABEL CÂBLES ADR

	Materiale cavo Cable made of Kabelmaterial Matériel câble	Formazione cavo Section Querschnitt Formation câble	Sezione cavo Cable diameter Kabeldurchmesser Section câble	Lunghezza Length Länge Longueur	Articolo Item no. Artikel-Nr. Article	Confezionamento Packaging Verpackung Emballage
 <p>ABS</p>	Poliuretano Polyurethane Poliurethan Polyuréthane (TPU) ISO 4141 ISO 6722	2x4+3x1,5 mm ²	Ø 11,5 mm	50 m	002000.00	
 <p>ABS</p>				500 m	002001.00	
 <p>EBS</p>	Poliuretano Polyurethane Poliurethan Polyuréthane (TPU) ISO 4141 ISO 6722	2x4+3x1,5 +1x(2x1,5) mm ²	Ø 13,5 mm	50 m	002002.00	
 <p>EBS</p>				500 m	002003.00	

	Descrizione Description Beschreibung Description	Articolo Item no. Artikel-Nr. Article	Confezionamento Packaging Verpackung Emballage
	<p><i>Dado + guarnizione presa ABS/EBS (cavo Ø 15,5mm)</i> <i>Nut + rubber seal for ABS/EBS socket (cable Ø 15,5mm)</i> <i>Überwurfmutter + Klemmdichtring zu ABS/EBS Steckdosen (Kabel Ø 15,5mm)</i> <i>Écrou + joint Prise ABS/EBS (câble Ø 15,5mm)</i></p>	<p>006011.00</p>	
	<p><i>Dado + guarnizione presa ABS/EBS (cavo Ø 7/12mm)</i> <i>Nut + rubber seal for ABS/EBS socket (cable Ø 7/12mm)</i> <i>Überwurfmutter + Klemmdichtring zu ABS/EBS Steckdosen (Kabel Ø 7/12mm)</i> <i>Écrou + joint Prise ABS/EBS (câble Ø 7/12mm)</i></p>	<p>006050.00</p>	
	<p><i>Kit contatti prese ABS (2x6+3x1,5mm²)</i> <i>Replacement set of pins for ABS socket (2x6+3x1,5mm²)</i> <i>Ersatz-Set Crimpkontakte zu ABS Steckdose (2x6+3x1,5mm²)</i> <i>Kit contacts Prise ABS (2x6+3x1,5mm²)</i></p>	<p>006012.00</p>	
	<p><i>Kit contatti prese ABS (2x4+3x1,5mm²)</i> <i>Replacement set of pins for ABS socket (2x4+3x1,5mm²)</i> <i>Ersatz-Set Crimpkontakte zu ABS Steckdose (2x4+3x1,5mm²)</i> <i>Kit contacts Prise ABS (2x4+3x1,5mm²)</i></p>	<p>006040.00</p>	
	<p><i>Kit contatti prese EBS (2x6+5x1,5mm²)</i> <i>Replacement set of pins for EBS socket (2x6+5x1,5mm²)</i> <i>Ersatz-Set Crimpkontakte zu EBS Steckdose (2x6+5x1,5mm²)</i> <i>Kit contacts Prise EBS (2x6+5x1,5mm²)</i></p>	<p>006014.00</p>	
	<p><i>Kit contatti prese EBS (2x4+5x1,5mm²)</i> <i>Replacement set of pins for EBS socket (2x4+5x1,5mm²)</i> <i>Ersatz-Set Crimpkontakte zu EBS Steckdose (2x4+5x1,5mm²)</i> <i>Kit contacts Prise EBS (2x4+5x1,5mm²)</i></p>	<p>006052.00</p>	
	<p><i>Kit contatti a vite prese 5 poli ABS</i> <i>Replacement set of screw pins for 5pin ABS socket</i> <i>Ersatz-Set Schraubkontakte zu ABS 5-polig Steckdose</i> <i>Kit contacts a vis prise 5 broches ABS</i></p>	<p>006044.00</p>	
	<p><i>Kit contatti a vite prese 7 poli EBS</i> <i>Replacement set of screw pins for 7 pin EBS socket</i> <i>Ersatz-Set Schraubkontakte zu EBS 7-polig Steckdose</i> <i>Kit contacts a vis prise 7 broches EBS</i></p>	<p>006045.00</p>	

	Descrizione Description Beschreibung Description	Articolo Item no. Artikel-Nr. Article	Confezionamento Packaging Verpackung Emballage
	Contatto maschio 6mm ² da crimpare per prese ABS/EBS Male crimp pins for ABS/EBS socket 6mm ² Kontaktstift zu ABS/EBS Steckdose, 6mm ² , Crimpanschluss Contact male 6mm ² Prise ABS/EBS	006016. 00	
	Contatto maschio 1,5mm ² da crimpare per prese ABS/EBS Male crimp pins for ABS/EBS socket 1,5mm ² Kontaktstift zu ABS/EBS Steckdose, 1,5mm ² , Crimpanschluss Contact male 1,5mm ² Prise ABS/EBS	006017. 00	
	Contatto maschio 4mm ² da crimpare per prese ABS/EBS Male crimp pins for ABS/EBS socket 4mm ² Kontaktstift zu ABS/EBS Steckdose, 4mm ² , Crimpanschluss Contact male 4mm ² Prise ABS/EBS	006024. 00	
	Contatto maschio a vite per prese ABS/EBS Male screw pins for ABS/EBS socket Kontaktstift zu Steckdosen ABS/EBS, Schraubanschluss Contact male borne Prise ABS/EBS	006044. 90	
	Kit terminali cablaggi ABS Replacement set of terminals for ABS harnesses Ersatz-Set Kontaktstifte zu ABS-Verbindungsleitungen Kit boîtes terminales câblages ABS	006020. 00	
	Kit contatti spine ABS (2x6+3x1,5mm ²) Replacement set of pins for ABS plug (2x6+3x1,5mm ²) Ersatz-Set Crimpkontakte zu ABS Stecker (2x6+3x1,5mm ²) Kit contacts Fiche ABS (2x6+3x1,5mm ²)	006013. 00	
	Kit contatti spine ABS (2x4+3x1,5mm ²) Replacement set of pins for ABS plug (2x4+3x1,5mm ²) Ersatz-Set Crimpkontakte zu ABS Stecker (2x4+3x1,5mm ²) Kit contacts Fiche ABS (2x4+3x1,5mm ²)	006041. 00	
	Kit contatti spine EBS (2x6+5x1,5mm ²) Replacement set of pins for EBS plug (2x6+5x1,5mm ²) Ersatz-Set Crimpkontakte zu EBS Stecker (2x6+5x1,5mm ²) Kit contacts Fiche EBS (2x6+5x1,5mm ²)	006015. 00	
	Kit contatti spine EBS (2x4+5x1,5mm ²) Replacement set of pins for EBS plug (2x4+5x1,5mm ²) Ersatz-Set Crimpkontakte zu EBS Stecker (2x4+5x1,5mm ²) Kit contacts Fiche EBS (2x4+5x1,5mm ²)	006053. 00	

	Descrizione Description Beschreibung Description	Articolo Item no. Artikel-Nr. Article	Confezionamento Packaging Verpackung Emballage
	Kit contatti a vite spine 5 poli ABS Replacement set of screw pins for 5 pin ABS plug Ersatz-Set Schraubkontakte zu ABS Stecker 5-polig Kit contacts a vis fiche 5 broches ABS	006046. 00	
	Kit contatti a vite spine 7 poli EBS Replacement set of screw pins for 7 pin EBS plug Ersatz-Set Schraubkontakte zu EBS Stecker 7-polig Kit contacts a vis fiche 7 broches EBS	006047. 00	
	Contatto femmina 6mm ² da crimpare per spine ABS/EBS Female crimp pins for ABS/EBS plug 6mm ² Kontakthülse zu ABS/EBS Stecker , 6mm ² , Crimpanschluss Contact femelle 6mm ² Fiche ABS/EBS	006018. 00	
	Contatto femmina 1,5mm ² da crimpare per spine ABS/EBS Female crimp pins for ABS/EBS plug 1,5mm ² Kontakthülse zu ABS/EBS Stecker , 1,5mm ² , Crimpanschluss Contact femelle 1,5mm ² Fiche ABS/EBS	006019. 00	
	Contatto femmina 4mm ² da crimpare per spine ABS/EBS Female crimp pins for ABS/EBS plug 4mm ² Kontakthülse zu ABS/EBS Stecker , 4mm ² , Crimpanschluss Contact femelle 4mm ² Fiche ABS/EBS	006027. 00	
	Contatto femmina a vite per spine ABS/EBS Female screw pins for ABS/EBS plug Kontakthülse zu Steckern ABS/EBS, Schraubanschluss Contact femelle borne Fiche ABS/EBS	006046. 90	
	Pinza per crimpatura contatti (ABS/EBS) Hand Crimping tool for pins (ABS/EBS) Crimpzange für Kontakte (ABS/EBS) Pince a crimper les contacts (ABS/EBS)	079903. 00	



ISO 4141

8

SPIRALI E CABLAGGI ABS/EBS 12/24V

SPIRAL COILS AND WIRING ABS/EBS 12/24V

SPIRALKABEL UND VERBINDUNGSKABEL ABS/EBS 12/24V

CORDONS ET CABLAGES ABS/EBS 12/24V



SPIRALI E CABLAGGI ABS/EBS 12/24V ISO 4141

Applicazioni: Le spirali elettriche con spine ABS (5poli) ed EBS (7poli) vengono utilizzate per effettuare il collegamento elettrico del sistema frenante tra motrice e semirimorchio nel settore dei veicoli commerciali ed industriali. Il sistema ABS /EBS, conformemente alle normative ISO/DIN 7638, è obbligatorio su veicoli che superino le 3,5 ton. Le caratteristiche tecniche dei materiali impiegati sono conformi alle specifiche dettate dalla Normativa ADR/GGVS per l'allestimento di veicoli adibiti al trasporto di merci pericolose.

Questi prodotti vengono realizzati un cavo conforme alla normativa ISO 4141 con guaina esterna in HYTREL (TEEE) o in TPU (Poliuretano).

L'HYTREL (TEEE) ha ottime caratteristiche di elasticità e di resistenza meccanica agli aggressivi chimici; è il materiale preferito per forniture di 1° impianto. E' disponibile in due versioni: con un diametro di spira di 80 mm. e di 40 mm., con lunghezza di lavoro da 3,5 a 4,5 m.

Il TPU (Poliuretano) è caratterizzato da una maggiore morbidezza ed elasticità anche alle basse temperature. Sono disponibili versioni con lunghezza di lavoro da 3,5m, 4m. e 4,5m. Il diametro spira di 30 mm. riduce sensibilmente l'ingombro creato dai numerosi collegamenti tra motrice e rimorchio. Queste caratteristiche lo rendono particolarmente apprezzato dal mercato dell'aftermarket.

Sono disponibili anche cablaggi per rimorchi con presa o con spina. ABS (5poli) ed EBS (7poli), di lunghezza da 6 a 12m., realizzati sia con cavo ADR che con guaina corrugata ADR in PA6.



SPIRAL COILS AND WIRING ABS/EBS 12/24V ISO 4141

Use: the electrical coils with ABS (5p) and EBS (7p) plugs are used for the electrical connection of the braking system between a truck tractor and a semi-trailer in the commercial vehicles sector. The ABS/EBS system, conforming to ISO/DIN 7638, is compulsory for vehicles over 3,5 tons. The technical specifications of the materials used conform to ADR/GGVS norm for vehicles transporting hazardous goods.

These products are supplied with cable conforming to ISO 4141; the external sheath is made of HYTREL® (TEEE) or POLYURETHANE (TPU).

HYTREL® (TEEE) has excellent qualities as regards elasticity and mechanical resistance as well as resistance against chemical agents and is used preferably by OEM's. The two versions available are supplied with 80 mm and 40 mm turn diameter respectively and working lengths of 3,5 to 4,5 m

POLYURETHANE (TPU) maintains greater smoothness and elasticity even at low temperatures. Versions available include working lengths of 3,5, 4 and 4,5 m. The 30 mm turn diameter thus minimizes the space taken by the numerous connections between tractor and trailer. Thanks to these characteristics it is particularly used in the aftermarket.

Also available are cables for trailers with ABS (5p) and EBS (7p) socket or plug, with lengths varying from 6 to 12 m, both with ADR cable or ADR conduit made of PA6.



SPIRALKABEL UND VERBINDUNGSKABEL ABS/EBS 12/24V ISO 4141

Anwendungen: Spiralkabel mit 5-poligen ABS und 7-poligen EBS Steckern dienen zum elektrischen Anschluss des Bremssystems zwischen Zugfahrzeug und Anhänger im Bereich Nutzfahrzeuge. Das ABS/EBS Bremssystem ist gemäß ISO /DIN 7638 für Fahrzeuge über 3,5 t Pflicht.

Die technischen Charakteristika der verwendeten Materialien entsprechen den Spezifikationen der ADR/GGVS Norm für Gefahrgut transportierende Fahrzeuge.

Diese Produkte werden mit einem ISO 4141 entsprechenden Kabel geliefert, mit äußerer Ummantelung aus HYTREL® (TEEE) oder POLYURETHAN(TPU).

HYTREL® (TEEE) ist in hohem Maße elastisch und widerstandsfähig – auch gegen chemische Stoffen und Abnutzung – und wird bei der Fertigung als Material bevorzugt. Verfügbar sind zwei Ausführungen mit 80 mm und 40 mm Windungs Durchmesser, und Arbeitslängen von 3,5 bis 4,5 m.

POLYURETHAN (TPU) dagegen bleibt auch bei niedrigen Temperaturen weich und elastisch. Verfügbar sind Ausführungen mit Arbeitslängen von 3,5m, 4 m und 4,5m. Der platzsparende Windungsdurchmesser von nur 30 mm trägt dazu bei, dass der durch die zahlreichen Anschlüsse zwischen Zugfahrzeug und Anhänger verursachte Umfang reduziert wird. Dank dieser Charakteristika ist das Produkt besonders für den Ersatzteilmarkt attraktiv.

Verfügbar sind auch Kabel für Anhänger mit Steckdose oder ABS (5-polig) oder EBS (7-polig) Stecker, Längen von 6 bis 12 m, die sowohl mit ADR Kabel als auch mit ADR Wellrohr aus PA6 geliefert werden können.



CORDONS ET CABLAGES ABS/EBS 12/24V ISO 4141

Applications: Les cordons électriques avec fiches ABS (5 pôles) et EBS (7 pôles) sont utilisées pour effectuer la connexion électrique du système de freinage entre un véhicule tracteur et une semiorque dans le secteur des véhicules commerciaux et industriels. Le système ABS/EBS, conformément à la normative ISO/DIN 7636, est obligatoire pour les véhicules dépassant les 3,5 t.

Les caractéristiques techniques des matériaux employés sont conformes aux spécificités imposées par la Normative ADR/GGVS pour l'équipement de véhicules destinés au transport de marchandises dangereuses.

Ces produits sont réalisés avec un câble conforme à la normative ISO 4141 avec gaine extérieure en HYTREL® (TEEE) ou en POLYURÉTHANE(TPU).

Le HYTREL® (TEEE) a d'excellentes caractéristiques d'élasticité, de robustesse mécanique et de résistance à l'agressivité chimique ; c'est le matériau préféré pour la fourniture de 1^o installation. C'est disponible en deux versions : avec un diamètre de spire de 80 mm et de 40 mm avec une longueur de travail de 3,5 à 4,5 m.

Le POLYURÉTHANE (TPU) se caractérise par une plus grande souplesse et élasticité même à de basses températures. Les versions disponibles sont avec longueur de travail de 3,5 m, 4 m et 4,5 m. Le diamètre de spire de 30 mm réduit sensiblement l'encombrement créé par les nombreuses connexions existant entre le véhicule tracteur et la remorque. Ces caractéristiques le rendent particulièrement apprécié par le marché de l'after-market.

Des câblages pour remorques avec prise ou avec fiche ABS (5 broches) et EBS (7 broches), de longueur de 6 à 12 m, réalisés aussi bien avec câble ADR qu'avec gaine gouffrée ADR en PA6.

SCHEMA DI CONNESSIONE
CONTACTS ALLOCATION
KONTAKTBELEGUNG
AFFECTATION DES CONTACTS

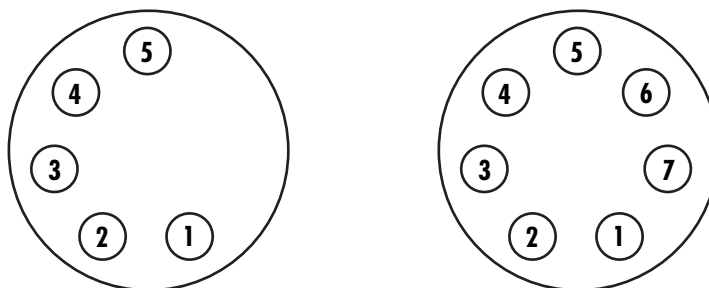

Connettori per ABS 24V e 12V Norma ISO 7638-1 e ISO7638-2 Connectors for ABS 24V and 12V IS 7638-1 AND ISO7638-2
Anschlüsse für ABS 24V und 12V ISO 7638-1 und ISO 7638-2 Connecteurs pour ABS 24V et 12V Norme ISO 7638-1 et ISO 7638-2







Contacto n Contact no Kontakt Nr. Contact n	Funzione Funktion Fonction	Sezione Cavo Cable Diameter Kabeldurchmesser Couleur Câble	Colore cavo Colour Kabelfarbe Couleur câble
1	Positivo alimentazione elettrovalvole Positive electrovalves Pos. Stromspeisung Elektroventile Positif alimentation électrovannes	4 o 6 mm ²	Rosso Red Rot Rouge
2	Positivo collegamenti elettronici Positive electronic connections Pos. elektronische Anschlussverbindungen Positif connexions électroniques	1,5 mm ²	Nero Black Schwarz Noir
3	Negativo collegamenti elettronici Negative electronic connections Neg. elektronische Anschlüsse Négatif connexions électroniques	1,5 mm ²	Giallo Yellow Gelb Jaune
4	Negativo alimentazione elettrovalvole Negative electrovalves Neg. Anschluss Elektroventile Négatif alimentation électrovannes	4 o 6 mm ²	Marrone Brown Braun Marron
5	Collegamento lampada spia Warning light connection Anschluss Warnlicht Connexion lampe témoin	1,5 mm ²	Bianco White Weiss Blanc





Connettori per EBS 24V e 12V Norma ISO 7638-1 e ISO7638-2 Connectors for EBS 24V and 12V IS 7638-1 AND ISO7638-2
Anschlüsse für EBS 24V und 12V ISO 7638-1 und ISO 7638-2 Connecteurs pour EBS 24V et 12V Norme ISO 7638-1 et ISO 7638-2

1	Positivo alimentazione elettrovalvole Positive electrovalves Pos. Stromspeisung Elektroventile Positif alimentation électrovannes	4 o 6 mm ²	Rosso Red Rot Rouge
2	Positivo collegamenti elettronici Positive electronic connections Pos. elektronische Anschlussverbindungen Positif connexions électroniques	1,5 mm ²	Nero Black Schwarz Noir
3	Negativo collegamenti elettronici Negative electronic connections Neg. elektronische Anschlüsse Négatif connexions électroniques	1,5 mm ²	Giallo Yellow Gelb Jaune
4	Negativo alimentazione elettrovalvole Negative electrovalves Neg. Anschluss Elektroventile Négatif alimentation électrovannes	4 o 6 mm ²	Marrone Brown Braun Marron
5	Collegamento lampada spia Warning light connection Anschluss Warnlicht Connexion lampe témoin	1,5 mm ²	Bianco White Weiss Blanc
6	Collegamento CANH CANH connection CANH Anschluss Connexion CANH	1,5 mm ²	Bianco/Verde White/Green Weiss/Grün Blanc/Vert
7	Collegamento CANL CANL connection CANL Anschluss Connexion CANL	1,5 mm ²	Bianco/Marrone White/Brown Weiss/Braun Blanc/Marron











	Materiale cavo Cable made of Kabelmaterial Matériel câble	Formazione cavo Section Querschnitt Formation câble	Sezione cavo Cable diameter Kabeldurchmesser Section câble	Diametro spira Turn diameter Windungsdurchmesser Diamètre spirale	Numero spire Number of turns Windungsanzahl Nombre spirales	
 <p>ABS</p>	<p>ABS HYTREL® (TEEE) ISO 4141</p>	<p>2x6+3x1,5 mm²</p>	<p>Ø 13,5 mm</p>	<p>Ø 80 mm</p>	<p>14 19</p>	
 <p>ABS</p>	<p>ABS HYTREL® (TEEE) ISO 4141</p>	<p>2x4+3x1,5 mm²</p>	<p>Ø 13,5 mm</p>	<p>Ø 80 mm</p>	<p>14 19</p>	
 <p>ABS</p>	<p>ABS HYTREL® (TEEE) ISO 4141</p>	<p>2x4+3x1,5 mm²</p>	<p>Ø 12 mm</p>	<p>Ø 40 mm</p>	<p>28,5</p>	



SPIRALI ABS/EBS SPIRAL COIL ABS/EBS SPIRALKABEL ABS/EBS CORDONS ÉLECTRIQUES ABS/EBS

L.L. Max. estensibile Max. extendable W.L. Max. ausziehbare A.L. Max. extensible L.T.	Norma Norm Norm Norme	Descrizione Description Beschreibung Description	Articolo Item no. Artikel-Nr. Article	Confezionamento Packaging Verpackung Emballage	Accessori Accessories Zubehör Accessoires
3,5 m		<p>Senza spine Without Plugs Ohne Stecker Sans Fiches</p>	005559. 00		
4,5 m			005558. 00		
3,5 m	<p>ISO 7638-1</p>	<p>Spine ABS 24V 5 poli 5 pin 24V ABS plugs ABS Steckern 5-polig 24V Fiches ABS 24V 5 broches</p>	005561. 70		<p>Manicotto in gomma Rubber cable guard Knickschutztülle Manchon en caoutchouc</p>
4,5 m			005560. 70		
4 m	<p>ISO 7638-1</p>	<p>Spine ABS 24V 5 poli 5 pin 24V ABS plugs ABS Steckern 5-polig 24V Fiches ABS 24V 5 broches</p>	005594. 70		<p>Manicotto in gomma Rubber cable guard Knickschutztülle Manchon en caoutchouc</p>













	Materiale cavo Cable made of Kabelmaterial Matériel câble	Formazione cavo Section Querschnitt Formation câble	Sezione cavo Cable diameter Kabeldurchmesser Section câble	Diametro spira Turn diameter Windungsdurchmesser Diamètre spirale	Numero spire Number of turns Windungsanzahl Nombre spirales	
 <p>EBS</p>	<p>EBS HYTREL® (TEEE)</p>	<p>2x4+5x1,5 mm²</p>	<p>Ø 13,5 mm</p>	<p>Ø 80 mm</p>	<p>14</p>	
 <p>EBS</p>				<p>ISO 4141</p>		
 <p>EBS</p>	<p>EBS HYTREL® (TEEE)</p>	<p>2x4+5x1,5 mm²</p>	<p>Ø 12 mm</p>			
 <p>EBS</p>				<p>ISO 4141</p>		

SPIRALI ABS/EBS SPIRAL COIL ABS/EBS SPIRALKABEL ABS/EBS CORDONS ÉLECTRIQUES ABS/EBS

L.L. Max. estensibile Max. extendable W.L. Max. ausziehbare A.L. Max. extensible L.T.	Norma Norm Norm Norme	Descrizione Description Beschreibung Description	Articolo Item no. Artikel-Nr. Article	Confezionamento Packaging Verpackung Emballage	Accessori Accessories Zubehör Accessoires
3,5 m		<i>Senza spine Without Plugs Ohne Stecker Sans Fiches</i>	005579. 70		
4,5 m			005574. 70		
3,5 m	ISO 7638-1 	<i>Spine EBS 24V 7 poli 7 pin 24V EBS plugs EBS Steckern 7-polig 24V Fiches EBS 24V 7 broches</i>	005579. 00		<i>Manicotto in gomma Rubber cable guard Knickschutzhülle Manchon en caoutchouc</i>
4,5 m			005574. 00		
3,5 m		<i>Senza spine Without Plugs Ohne Stecker Sans Fiches</i>	005587. 70		
4,5 m			005584. 70		
3,5 m	ISO 7638-1 	<i>Spine EBS 24V 7 poli 7 pin 24V EBS plugs EBS Steckern 7-polig 24V Fiches EBS 24V 7 broches</i>	005587. 00		<i>Manicotto in gomma Rubber cable guard Knickschutzhülle Manchon en caoutchouc</i>
4,5 m			005584. 00		

	Materiale cavo Cable made of Kabelmaterial Matériel câble	Formazione cavo Section Querschnitt Formation câble	Sezione cavo Cable diameter Kabeldurchmesser Section câble	Diametro spira Turn diameter Windungsdurchmesser Diamètre spirale	Numero spire Number of turns Windungszahl Nombre spirales	
 <p>ABS</p>	<p>ABS</p> <p>Poliuretano Polyurethane Poliurethan Polyuréthane (TPU)</p> <p>ISO 4141</p>	<p>2x4+3x1,5 mm²</p>	<p>Ø 13,5 mm</p>	<p>Ø 30 mm</p>	<p>30,5</p>	
 <p>ABS</p>					<p>41,5</p>	
 <p>ABS</p>					<p>30,5</p>	
 <p>ABS</p>					<p>41,5</p>	
 <p>EBS</p>	<p>EBS</p> <p>Poliuretano Polyurethane Poliurethan Polyuréthane (TPU)</p> <p>ISO 4141</p>	<p>2x4+5x1,5 mm²</p>	<p>Ø 13,5 mm</p>	<p>Ø 30 mm</p>	<p>35,5</p>	
 <p>EBS</p>						

SPIRALI ABS/EBS SPIRAL COIL ABS/EBS SPIRALKABEL ABS/EBS CORDONS ÉLECTRIQUES ABS/EBS

L.L. Max. estensibile Max. extendable W.L. Max. ausziehbare A.L. Max. extensible L.T.	Norma Norm Norm Norme	Descrizione Description Beschreibung Description	Articolo Item no. Artikel-Nr. Article	Confezionamento Packaging Verpackung Emballage	Accessori Accessories Zubehör Accessoires
3,5 m	ISO 7638-2	Senza spine Without Plugs Ohne Stecker Sans Fiches	005565. 00		
4,5 m		Spine ABS 12V 5 poli 5 pin 12V ABS plugs ABS Steckern 5-polig 12V Fiches ABS 12V 5 broches	005564. 00		
3,5 m	ISO 7638-1	Spine ABS 24V 5 poli 5 pin 24V ABS plugs ABS Steckern 5-polig 24V Fiches ABS 24V 5 broches	005569. 00		Manicotto in gomma Rubber cable guard Knickschutzhülle Manchon en caoutchouc
4,5 m		Spine ABS 24V 5 poli 5 pin 24V ABS plugs ABS Steckern 5-polig 24V Fiches ABS 24V 5 broches	005568. 00		Manicotto in gomma Rubber cable guard Knickschutzhülle Manchon en caoutchouc
3,5 m	ISO 7638-1	Spine ABS 24V 5 poli 5 pin 24V ABS plugs ABS Steckern 5-polig 24V Fiches ABS 24V 5 broches	005567. 70		Manicotto in gomma Rubber cable guard Knickschutzhülle Manchon en caoutchouc
4,5 m		Spine ABS 24V 5 poli 5 pin 24V ABS plugs ABS Steckern 5-polig 24V Fiches ABS 24V 5 broches	005566. 70		Manicotto in gomma Rubber cable guard Knickschutzhülle Manchon en caoutchouc
4 m	ISO 7638-1	Senza spine Without Plugs Ohne Stecker Sans Fiches	005587. 80		
4 m		Spine EBS 24V 7 poli 7 pin 24V EBS plugs EBS Steckern 7-polig 24V Fiches EBS 24V 7 broches	005587. 85		Manicotto in gomma Rubber cable guard Knickschutzhülle Manchon en caoutchouc



**ISO 4165 / DIN 72591
DIN 9680**

9

PRESE & SPINE 2/3 POLI

**2/3 PINS SOCKETS & PLUGS
2/3-POLIGE STECKDOSEN & STECKER
PRISES & FICHES 2/3 BROCHES**





PRESE & SPINE 2 POLI ISO 4165 / DIN 72591

Applicazioni: questi connettori sono utilizzati per il collegamento elettrico di lampade di ispezione, lampade rotanti ed altri accessori su veicoli con impianto elettrico a 12V. e 24V. Contatti in ottone con attacchi posteriori a vite o faston (lamellari) da 6,3mm.

Le prese sono realizzate in versione da pannello, con e senza coperchio, e in versione per montaggio esterno.



PRESE & SPINE 3 POLI DIN 9680

Applicazioni: questi connettori sono utilizzati, principalmente su macchine agricole e rimorchi, per effettuare collegamenti elettrici supplementari di vario genere. Due contatti in ottone nichelato da 25A con attacchi posteriori faston (lamellari) doppi da 6,3mm. ed un contatto supplementare da 5 A con attacco posteriore faston da 3,5mm.



2 PINS SOCKETS & PLUGS ISO 4165 / DIN 72591

Use: these connectors are used for the electrical connection of inspection lights, beacons and other accessories on vehicles with 12V and 24V electrical system. Contacts made of brass with 6,3 mm screw or spade terminals.

The sockets are available for in-the-cab mounting, with and without lid, and in a version for external mounting.



3 PINS SOCKETS & PLUGS DIN 9680

Use: these connectors are mainly used for agricultural vehicles and trailers, for various types of additional connections. Two contacts made of nickel-plated brass 25A with double 6,3 mm spade terminals and an additional 5A contact with 3,5 mm spade terminal.



2-POLIGE STECKDOSEN & STECKER ISO 4165 / DIN 7259 I

Anwendung: diese Steckverbindungen dienen zum elektrischen Anschluss von Kontrollleuchten, rotierenden Lampen und unterweitigen Accessoires an Fahrzeugen mit 24V und 12V Schaltung. Kontakte aus Messing mit hinterem 6,3 mm Schraub- oder Flachsteckanschluss.

Steckdosenausführung als Schalttafel mit oder ohne Deckel, oder für Aussenmontage.



3-POLIGE STECKDOSEN & STECKER DIN 9680

Anwendung: diese Verbindungsstecker dienen hauptsächlich für zusätzliche Anschlüsse verschiedener Art bei landwirtschaftlichen Maschinen und Anhängern. Zwei Kontakte aus vernickeltem Messing für 25 Ampere mit hinteren doppelten 6,3 mm Flachsteckanschlüssen, sowie ein zusätzlicher 5A Kontakt mit hinterem 3,5 mm Flachsteckanschluss.



PRISES & FICHES 2 BROCHES ISO 4165 / DIN 7259 I

Applications: ces connecteurs sont utilisés pour la connexion électrique de lampes d'inspection, lampes gyrophares et autres accessoires sur véhicules avec installation électrique à 12 V et 24 V. Contacts en laiton avec attaches arrière à serre-fils ou cosses plates de 6,3 mm.

Les prises sont réalisées en version pour panneau, avec ou sans couvercle et en version pour montage extérieur.











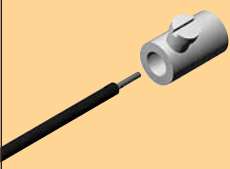



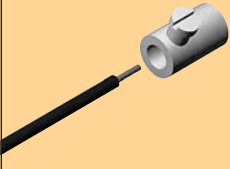





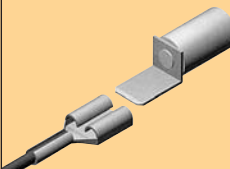

PRISES & FICHES 3 BROCHES DIN 9680

Applications: ces connecteurs sont utilisés principalement sur des machines agricoles et des remorques pour effectuer des connexions électriques supplémentaires de différents genres. Deux contacts en laiton nickelé de 25 A avec attaches arrière à cosses plates de 6,3 mm et un contact supplémentaire de 5 A avec attache arrière à cosses plates de 3,5 mm.





PRESE 2 POLI 2 PINS SOCKETS 2-POLIGE STECKDOSEN PRISES 2 BROCHES

	Materiale corpo Material Corps Material Matériel	Norma Norm Norm Norme	Tipo contatti Type of contact Anschluss Type contacts	Articolo Item no. Artikel-Nr. Article	Confezionamento Packaging Verpackung Emballage
 <p>Preso 2 poli fissaggio esterno 2 pin outside fitting socket Aufbausteckdose 2-polig Prise 2 broches externe</p>	AL	DIN 72591 ISO 4165		006806.00	
 <p>Preso 2 poli con coperchio 2 pin built-in aluminium socket with plastic lid Steckdose 2-polig mit Kunststoffdeckel Prise 2 broches avec couvercle</p>				006808.00	
 <p>Preso 2 poli senza coperchio 2 pin built-in aluminium socket without plastic lid Steckdose 2-polig ohne Kunststoffdeckel Prise 2 broches sans couvercle</p>				006810.00	
 <p>Preso 2 poli 2 attacchi a vite con coperchio 2 pin 2 screw terminals built-in aluminium socket with plastic lid Steckdose 2-polig mit Kunststoffdeckel, 2 Schraubanschluss Prise 2 broches 2 contacts a vis avec couvercle</p>	ON	DIN 72591 ISO 4165		006813.00	
 <p>Preso 2 poli con coperchio 2 pin built-in aluminium socket with plastic lid Steckdose 2-polig mit Kunststoffdeckel Prise 2 broches avec couvercle</p>				006807.00	
 <p>Preso 2 poli senza coperchio 2 pin built-in aluminium socket without plastic lid Steckdose 2-polig ohne Kunststoffdeckel Prise 2 broches sans couvercle</p>				006809.00	
 <p>Preso 2 poli 2 attacchi faston con coperchio 2 pin 2 flat terminals built-in aluminium socket with plastic lid Steckdose 2-polig mit Kunststoffdeckel, 2 Flachsteckanschluss Prise 2 broches 2 cosses plates avec couvercle</p>				006811.00	
 <p>Preso 2 poli 2 attacchi faston senza coperchio 2 pin 2 flat terminals built-in aluminium socket without plastic lid Steckdose 2-polig ohne Kunststoffdeckel, 2 Flachsteckanschluss Prise 2 broches 2 cosses plates sans couvercle</p>				006812.00	
 <p>Preso 2 poli 2 attacchi faston senza dado e rondella 2 pin socket with 2 flat terminals without nut and washer Steckdose mit 2 Flachsteckanschlüssen, ohne Mutter und Rosette Prise 2 broches sans écrou ni rondelle</p>				006812.60	
 <p>Preso 2 poli 2 attacchi faston a T con coperchio 2 pin 2 T-shaped flat terminals built-in aluminium socket with plastic lid Steckdose 2-polig mit Kunststoffdeckel, 2 T-förmigen Flachsteckanschluss Prise 2 broches 2 cosses plates en T avec couvercle</p>				006802.00	

SPINA 2 POLI 2 PINS PLUGS 2-POLIGE STECKER FICHES 2 BROCHES

	Materiale corpo Material Corps Material Matériel	Norma Norm Norm Norme	Tipo contatti Type of contact Anschluss Type contacts	Articolo Item no. Artikel-Nr. Article	Confezionamento Packaging Verpackung Emballage
 <p>Spina 2 poli 2 pin plug Stecker 2-polig Fiche 2 broches</p>		DIN 72591 ISO 4165		006804.00	
				006803.00	
 <p>Spina 2 poli DIN con adattatore per presa accendino 2 pin universal plug fitting to cigarette lighter sockets and DIN sockets Stecker 2-polig zu Zigarettenzundersteckdose durch abziehen des Adapters passend zu-DIN Steckdosen Fiche 2 broches DIN avec adaptateur prise allume-cigares</p>				006815.00	

ACCESSORI ACCESSORIES ZUBEHÖR ACCESSOIRES ACCESSORI ACCESSORIES ZUBEHÖR ACCESSOIRES

	Descrizione Description Beschreibung Description	Articolo Item no. Artikel-Nr. Article	Confezionamento Packaging Verpackung Emballage
	Coperchio prese 2 poli Thermoplastic lid for 2 pin sockets Kunststoffdeckel zu 2-polig Steckdosen Couvercle prises 2 broches	006814.00	
		006814.90	

PRESE 3 POLI 3 PINS SOCKETS 3-POLIGE STECKDOSEN PRISES 3 BROCHES



Presà 3 poli 2 fori di fissaggio
3 pin socket with 3 flat terminals, 2 fixing holes
Steckdose 3-polig mit 2 Befestigungslöchern
Prise 3 broches 2 trous

PL

DIN 9680

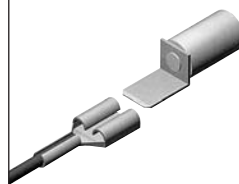

006817.00

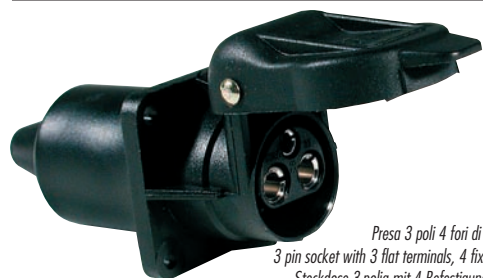

Presà 3 poli 4 fori di fissaggio
3 pin socket with 3 flat terminals, 4 fixing holes
Steckdose 3-polig mit 4 Befestigungslöchern
Prise 3 broches 4 trous

PL

006816.00



SPINE 3 POLI 3 PINS PLUGS 3-POLIGE STECKER FICHES 3 BROCHES



Spina 3 poli attacchi faston
 3 pin plug with 3 flat terminals
 Stecker mit 3 Flachsteckanschlüssen
 Fiche 3 broches cosses plates

PL

DIN 9680

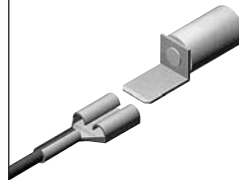

006818.00



-
- **DISEGNI, CARATTERISTICHE E CODIFICHE POSSONO ESSERE SOGGETTI A MODIFICHE E VARIAZIONI**
 - **DRAWINGS, SPECIFICATIONS AND REFERENCE NUMBERS MAY BE MODIFIED OR CHANGED**
 - **ZEICHNUNGEN, MERKMALE UND KODIFICATIONEN KÖNNEN MODIFIZIERUNGEN UND ÄNDERUNGEN UNTERWORFEN SEIN**
 - **LES DESSINS, LES CARACTERISTIQUES ET LES REFERENCES PEUVENT ETRE MODIFIEES OU CHANGEES**

ELENCO CODICI PRODUCT CODE INDEX **ARTIKELVERZEICHNIS** INDEX REFERENCES

Cod. art. Part no. Art.-Nr. Réf.	pag. page Seite page	Cod. art. Part no. Art.-Nr. Réf.	pag. page Seite page	Cod. art. Part no. Art.-Nr. Réf.	pag. page Seite page	Cod. art. Part no. Art.-Nr. Réf.	pag. page Seite page	Cod. art. Part no. Art.-Nr. Réf.	pag. page Seite page	Cod. art. Part no. Art.-Nr. Réf.	pag. page Seite page
---	-------------------------------	---	-------------------------------	---	-------------------------------	---	-------------------------------	---	-------------------------------	---	-------------------------------

00200000	86	00420900	80	00427390	14	00516790	11	00550970	53	00556500	99
00200100	86	00421000	27	00427399	14	00516799	11	00550980	49	00556670	99
00200200	86	00421100	14	00431100	10	00516900	11	00550990	49	00556770	99
00200300	86	00421190	14	00431190	10	00516990	11	00551000	51	00556800	99
00200800	42	00421199	14	00431199	10	00516999	11	00551300	55	00556900	99
00200900	42	00421300	24	00431500	10	00517700	13	00551400	51	00557400	97
00201200	67	00421390	24	00431700	10	00517790	13	00551500	51	00557470	97
00201300	67	00421399	24	00431790	10	00517799	13	00551800	51	00557900	97
00201400	28	00421400	24	00431799	10	00519000	15	00551900	51	00557970	97
00201500	28	00421462	24	00433100	12	00519090	15	00552000	51	00558400	97
00226800	65	00421490	24	00433700	12	00519099	15	00552300	49	00558470	97
00227300	65	00421499	24	00433790	12	00519100	17	00552400	51	00558700	97
00227800	65	00421600	27	00433799	12	00519200	17	00552500	51	00558770	97
00250000	17	00421700	14	00435700	12	00519700	15	00552600	49	00558780	99
00250100	17	00421790	14	00437200	10	00519790	15	00552700	49	00558800	51
00250200	28	00421799	14	00437290	10	00519799	15	00552800	51	00558785	99
00250300	28	00421900	14	00437299	10	00520500	79	00552900	51	00558900	51
00250500	28	00421990	14	00510990	25	00520600	79	00553100	55	00559070	73
00401100	14	00422600	24	00511000	25	00520670	79	00553200	55	00559071	73
00401190	14	00422690	24	00511100	25	00520700	81	00553800	49	00559170	73
00401199	14	00422699	24	00511160	25	00520800	81	00554000	51	00559171	73
00401700	14	00423100	16	00511190	25	00520870	81	00554100	51	00559470	95
00401790	14	00423190	16	00511199	25	00524800	18	00554400	49	00559570	73
00401799	14	00423199	16	00511200	25	00549700	18	00554500	49	00559571	73
00403100	16	00423700	16	00511290	25	00549799	18	00554600	27	00559670	73
00403190	16	00423790	16	00511299	25	00549800	18	00554690	27	00559671	73
00403199	16	00423799	16	00511300	25	00549899	18	00554700	62	00559680	73
00403700	16	00425000	78	00511390	25	00550191	55	00554900	26	00559685	73
00403790	16	00425070	78	00511399	25	00550400	55	00555000	27	00560000	27
00403799	16	00425100	78	00511700	15	00550500	53	00555100	26	00560090	27
00405700	16	00425170	78	00511790	15	00550570	53	00555200	27	00560200	62
00420100	24	00425200	78	00511799	15	00550600	53	00555300	64	00560300	26
00420190	24	00425270	78	00511900	15	00550670	53	00555400	64	00560390	26
00420199	24	00425300	80	00511990	15	00550700	53	00555700	63	00560400	26
00420200	78	00425370	80	00511999	15	00550770	53	00555770	63	00560490	26
00420300	80	00425400	80	00512700	17	00550800	53	00555800	95	00560800	65
00420500	78	00425470	80	00512790	17	00550870	53	00555900	95	00560860	65
00420600	86	00425500	80	00512799	17	00550880	49	00556070	95	00560861	65
00420700	80	00425570	80	00516500	11	00550890	49	00556170	95	00560900	42
00420800	78	00427300	14	00516700	11	00550900	53	00556400	99	00561000	42

ELENCO CODICI PRODUCT CODE INDEX **ARTIKELVERZEICHNIS** INDEX REFERENCES

Cod. art. Part no. Art.-Nr. Réf.	pag. page Seite page	Cod. art. Part no. Art.-Nr. Réf.	pag. page Seite page	Cod. art. Part no. Art.-Nr. Réf.	pag. page Seite page	Cod. art. Part no. Art.-Nr. Réf.	pag. page Seite page	Cod. art. Part no. Art.-Nr. Réf.	pag. page Seite page	Cod. art. Part no. Art.-Nr. Réf.	pag. page Seite page
00561100	42	00584570	60	00590900	35	00600000	43	00603360	29	00606200	28
00580000	40	00584600	60	00590990	35	00600100	43	00603400	29	00606362	28
00580700	36	00584670	60	00590999	35	00600200	19	00603500	29	00606600	19
00580790	36	00584700	60	00591100	37	00600300	43	00603600	29	00606600	29
00580799	36	00584800	60	00591190	37	00600360	43	00603690	29	00606700	19
00580900	34	00584870	60	00591199	37	00600400	19	00603700	29	00606700	29
00580990	34	00585000	40	00591200	37	00600460	19	00603790	29	00606900	15
00580999	34	00585100	38	00591300	35	00600500	19	00604000	87	00606900	17
00581000	36	00585190	38	00591400	37	00600600	19	00604100	88	00680200	104
00581090	36	00585199	38	00591600	35	00600700	19	00604300	29	00680300	105
00581100	36	00585200	38	00591690	35	00600800	43	00604400	87	00680400	105
00581190	36	00585290	38	00591699	35	00601000	43	00604490	66	00680600	104
00581199	36	00585299	38	00591700	35	00601100	66	00604490	88	00680700	104
00581200	36	00585300	38	00594500	61	00601100	87	00604500	87	00680800	104
00581300	36	00585400	40	00594570	61	00601200	87	00604600	89	00680900	104
00581400	36	00585500	82	00594600	61	00601300	88	00604690	67	00681000	104
00581500	34	00585570	82	00594670	61	00601400	87	00604690	89	00681100	104
00581600	34	00585600	86	00594700	83	00601500	88	00604700	89	00681200	104
00581690	34	00585700	84	00594770	83	00601600	88	00604800	66	00681260	104
00581699	34	00585770	84	00594800	85	00601660	88	00604890	66	00681300	104
00581700	34	00585800	82	00594870	85	00601700	88	00604900	67	00681400	105
00583600	82	00585870	82	00595100	39	00601761	88	00604990	67	00681490	105
00583670	82	00585900	84	00595190	39	00601762	66	00605000	66	00681500	105
00583700	82	00585970	84	00595199	39	00601800	89	00605000	87	00681600	106
00583770	82	00586000	40	00595200	39	00601900	89	00605100	29	00681700	106
00583800	82	00586100	38	00595290	39	00601960	67	00605200	87	00681800	107
00583870	82	00586190	38	00595299	39	00602000	88	00605300	88	00901300	29
00583900	84	00586199	38	00595300	83	00602400	88	00605400	66	07990300	29
00583970	84	00586200	38	00595370	83	00602460	88	00605500	67	07990300	66
00584000	84	00586290	38	00595400	41	00602500	66	00605600	29	07990300	89
00584070	84	00586299	38	00595700	85	00602700	89	00605690	29		
00584100	84	00586300	38	00595770	85	00602800	67	00605700	19		
00584170	84	00586400	40	00596100	39	00602900	43	00605790	19		
00584200	60	00586800	82	00596190	39	00603000	43	00605799	19		
00584270	60	00586870	82	00596199	39	00603060	43	00605800	19		
00584300	60	00586900	84	00596200	39	00603100	43	00605800	29		
00584370	60	00586970	84	00596290	39	00603160	43	00605890	19		
00584400	60	00590700	37	00596299	39	00603200	19	00605890	29		
00584470	60	00590790	37	00596400	41	00603260	19	00605899	19		
00584500	60	00590799	37	00599100	18	00603300	29	00605900	43		



Il sistema qualità MEMBER'S è in continua evoluzione ed attualmente risulta certificato secondo le norme ISO 9001 Sistema Qualità Aziendale, ISO/TS 16949 Sistema Gestione Qualità Settore Automotive.

MEMBER'S ha ottenuto la certificazione ATEX relativa all'idoneità alla produzione di componenti da impiegare in ambienti esplosivi, e la certificazione UNI EN ISO 14001 : 2004 relativa al sistema di gestione ambientale.



The MEMBER'S quality control system is continually evolving and is currently certified to ISO 9001 Company Quality System, and ISO/TS 16949 Quality Management System for the Automobile sector.

MEMBER'S has also obtained ATEX certification for its suitability for production of components to be used in explosive environments, and UNI EN ISO 14001 certification : 2004 with regard to its environmental management system.



Das QM-System von MEMBER'S ist ständig verbesserungsorientiert und ist aktuell nach ISO 9001 und ISO/TS 16949 (Qualitätsmanagement System im Automotive Bereich) zertifiziert.















MEMBER'S hat die Zertifizierung über die Einsatzfähigkeit von seinen spezifischen Produkten in explosionsgefährdete Atmosphäre entsprechend der ATEX Richtlinie erhalten. Nicht zuletzt ist MEMBER'S hinsichtlich des Umweltmanagement System nach UNI EN ISO 14001 : 2004 zertifiziert.











Le service qualité de Member's est toujours en évolution, et maintenant il est certifié selon les normes ISO 9001 SYSTEME QUALITE' D'ENTREPRISE, ISO/TS 16949 SYSTEME GESTION QUALITE' du secteur automotive.

MEMBER'S a obtenu la certification Atex concernant l'aptitude a la production de composants a employer en milieux explosifs, et la certification uni en ISO 14001 : 2004 concernant le systeme de gestion du milieu.

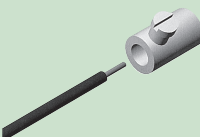
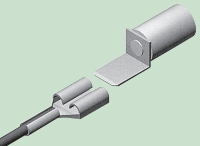
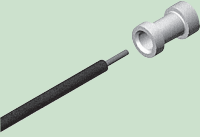
Legenda Key to symbols **Legende** Légende

Prodotto Product Produkt Produit		
Norma Norm Norm Norme	N Normale / Normal / Normal / Normale S Supplementare / Supplementary / Zusätzlich / Supplémentaire	
Prese Sockets Steckdosen Prises	Spine Plugs Stecker Fiches	
Prese 12v 5 Poli 5 Pins Sockets 12v 5-polige Steckdosen 12v Prises 12v 5 Broches	DIN 72576  N	DIN 72576  N Spine 12v 5 Poli 5 Pins Plugs 12v 5-polige Stecker 12v Fiches 12v 5 Broches
Prese 12v 7 Poli 7 Pins Sockets 12v 7-polige Steckdosen 12v Prises 12v 7 Broches	ISO 1724  N	ISO 1724  N Spine 12v 7 Poli 7 Pins Plugs 12v 7-polige Stecker 12v Fiches 12v 7 Broches
Prese 12v 13 Poli 13 Pins Sockets 12v 13-polige Steckdosen 12v Prises 12v 13 Broches	ISO 11446 DIN 72570  S	ISO 11446 DIN 72570  S Spine 12v 13 Poli 13 Pins Plugs 12v 13-polige Stecker 12v Fiches 12v 13 Broches
Prese 24v 7 Poli 7 Pins Sockets 24v 7-polige Steckdosen 24v Prises 24v 7 Broches	ISO 1185 DIN 72579  N	ISO 1185 DIN 72579  N Spine 24v 7 Poli 7 Pins Plugs 24v 7-polige Stecker 24v Fiches 24v 7 Broches
Prese 24v 15 Poli 15 Pins Sockets 24v 15-polige Steckdosen 24v Prises 24v 15 Broches	ISO 12098  S	ISO 12098  S Spine 24v 15 Poli 15 Pins Plugs 24v 15-polige Stecker 24v Fiches 24v 15 Broches
Prese ABS Sockets ABS Steckdosen ABS Prises ABS	ISO 7638  S	ISO 7638  S Spine ABS Plugs ABS Stecker ABS Fiches ABS
Prese EBS Sockets EBS Steckdosen EBS Prises EBS	ISO 7638  S	ISO 7638  S Spine EBS Plugs EBS Stecker EBS Fiches EBS

Lunghezza Spirali Coils Length Spiralkabel Länge Cordons Électriques Longueur	
L.L. Max. estensibile Max. extendable W.L. Max. ausziehbare A.L. Max. extensible L.T.	Lunghezza di lavoro massima estensibile Maximum extendable working length Maximal ausziehbare Länge Maximum extensible longueur de travail
Materiale corpo Material Corps Material Matériel	
Alluminio Aluminium Aluminium	AL  AL Alluminio verniciato nero Aluminium corrosion-proof Aluminium mit schwarzem Rostschutzmittel Aluminium teint en noir
Plastica Plastic Kunststoff Plastique	PL 
Materiale contatti Pins made of Material Kontakt Matériel contacts	
Ottone Brass Messing Laiton	O  ON  Ottone Nickelato Nickel-plated Brass Messing-vernickelt Laiton Nickelé
Tipo contatti Type of contact Anschluss Type contacts	
	A vite Screw type Schraubanschlüsse À vis
	Faston Flat type Flachstecker Cosses plates
	Da crimpare Crimped type Krimpkontakt À crimper
Confezionamento Packaging Verpackung Emballage	
	Individuale 1 per X Individual 1/ X Einzelverpackung 1/ X Stück Unitaire 1/ X
	Industriale 1 per XXX Bulk packaging of XXX pcs. Sammelverpackung 1/ XXX Stück Industriel par XXX
	Industriale smontato 1 per XXX Bulk packaging with disassembled parts of XXX pcs. Sammelverpackung demontiert 1/ XXX Stück Industriel articles non montés par XXX



Via Ghiacciaia,1 - 37045 LEGNAGO (Verona)
Tel. +39 0442 606200 - Fax +39 0442 28855
www.members.it - e-mail: members@members.it
