

POWR-GARD® Fuse

CLASS T – JLLN / JLLS SERIES

300/600 V ac • Fast-Acting • 1–1200 A



Description

JLLN / JLLS series fuses are less than 1/3 the size of comparable Class R fuses and are typically used for short circuit protection of drives and surge sensitive components. When rated in accordance with the NEC*, JLLN / JLLS fuses provide fast-acting overload and short circuit protection for non-inductive circuits and equipment.

Features/Benefits

- Extremely current-limiting
- Compact design
- 200 kA interrupting rating
- JLLN 35–60 amperes available with PCB mounts

Applications

- Variable speed drive protection
- Power conversion devices (inverters, rectifiers, UPS)
- Power supplies and power distribution units
- Compact mains switches

Recommended Fuse Holders

LFT30 series
LFT60 series
LSCR series for 70–800 amperes

Web Resources

Download TC curves, CAD drawings and other technical information: Littelfuse.com/jlln
Littelfuse.com/jlls

*NEC is a trademark of it's respective owner.

Specifications

JLLN

Voltage Ratings

Ac: 300 V
Dc: 160 V (1–60 A)
125 V (70–1200 A)

Ampere Range

1–1200 A

Interrupting Ratings

Ac: 200 kA rms symmetrical
Dc: 50 kA (1–30 A)
20 kA (35–1200 A)

Approvals

Ac: UL Standard 248-15, Class T
UL Listed (File: E81895): 1–1200 A
CSA Certified (File: LR29862): 1–600 A

Material

1–30 A: melamine body, bronze caps

Environmental

35–1200 A: melamine body, copper caps
RoHS compliant

JLLS

Voltage Ratings

Ac: 600 V

Dc: 300 V

Ampere Range

1–1200 A

Interrupting Ratings

Ac: 200 kA rms symmetrical

Dc: 20 kA

Approvals

Ac: UL Standard 248-15, Class T
UL Listed (File: E81895): 1–1200 A
CSA Certified (File: LR29862): 1–600 A

Material

1–30 A: melamine body, copper caps

35–60 A: melamine body, bronze caps

70–1200 A: melamine body, copper caps

Environmental

RoHS compliant

Part Numbering System

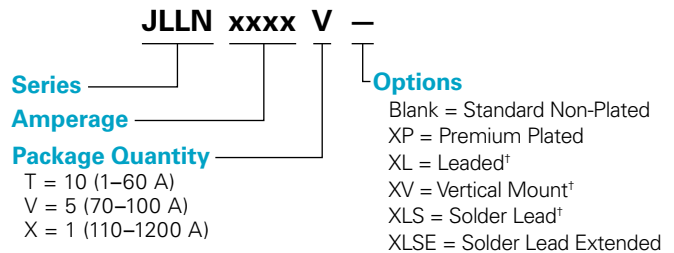

SERIES	AMP	PACK SIZE	PLATING SUFFIX	MOUNT SUFFIX	CATALOG NUMBER	ORDERING NUMBER
JLLS	6	T	–	–	JLLS006	JLLS006.T
JLLN	35	T	–	XL†	JLLN035L	JLLN035.TXL
JLLN	40	T	–	XLSE†	JLLN040LSE	JLLN040.TXLSE
JLLN	100	V	XP	–	JLLN100P	JLLN100.VXP

†Option is available for JLLN 35–60 amperes only. Premium plating is standard

Ordering Information

AMPERE RATINGS					
1	25	70	175	450	1100
2	30	80	200	500	1200
3	35	90	225	600	
6	40	100	250	700	
10	45	110	300	800	
15	50	125	350	900*	
20	60	150	400	1000	

*JLLS only

Dimensions
Inches (mm)

AMPERES	REFER TO FIG. NO.	SERIES	DIMENSIONS INCHES (mm)						
			A	B	C	D	E	F	G
1–30	1	JLLN	.875 (22.2)	—	.281 (7.1)	.406 (10.3)	—	—	—
		JLLS	1.500 (38.1)	—	.281 (7.1)	.562 (14.3)	—	—	—
35–60	1	JLLN	.875 (22.2)	—	.281 (7.1)	.562 (14.3)	—	—	—
	2	JLLS	1.562 (39.7)	.812 (20.6)	.406 (10.3)	.994 (25.2)	.062 (1.6)	1.094 (27.8)	—
70–100	3	JLLN	2.156 (54.8)	1.562 (39.7)	.750 (19.1)	.812 (20.6)	.830 (21.1)	.281 (7.1)	.125 (3.2)
		JLLS	2.953 (75.0)	2.352 (59.7)	.750 (19.1)	.828 (21.0)	1.625 (41.3)	.281 (7.1)	.125 (3.2)
110–200	3	JLLN	2.437 (61.9)	1.687 (42.9)	.875 (22.2)	1.062 (27.0)	.830 (21.1)	.343 (8.7)	.187 (4.8)
		JLLS	3.250 (82.6)	2.507 (63.7)	.875 (22.2)	1.078 (27.4)	1.656 (42.1)	.343 (8.7)	.187 (4.8)
225–400	3	JLLN	2.750 (69.9)	1.843 (46.8)	1.000 (25.4)	1.312 (33.3)	.828 (21.0)	.406 (10.3)	.250 (6.4)
		JLLS	3.625 (92.1)	2.718 (69.1)	1.000 (25.4)	1.593 (40.5)	1.712 (43.5)	.406 (10.3)	.250 (6.4)
450–600	3	JLLN	3.062 (77.8)	2.031 (51.6)	1.250 (31.8)	1.593 (40.5)	.875 (22.2)	.484 (12.3)	.312 (7.9)
		JLLS	3.984 (101.2)	2.953 (75.0)	1.250 (31.8)	2.062 (52.4)	1.765 (44.8)	.484 (12.3)	.312 (7.9)
700–800	3	JLLN	3.375 (85.7)	2.218 (56.4)	1.750 (44.5)	2.062 (52.4)	.875 (22.2)	.546 (13.9)	.375 (9.5)
		JLLS	4.328 (109.9)	3.171 (80.6)	1.750 (44.5)	2.500 (63.5)	1.860 (47.2)	.546 (13.9)	.375 (9.5)
900–1200	3	JLLN	4.000 (101.6)	2.531 (64.3)	2.000 (50.8)	2.500 (63.5)	1.033 (26.2)	.609 (15.5)	.437 (11.1)
		JLLS	5.271 (133.9)	3.801 (96.5)	2.000 (50.8)	2.625 (66.7)	2.303 (58.5)	.609 (15.5)	.437 (11.1)

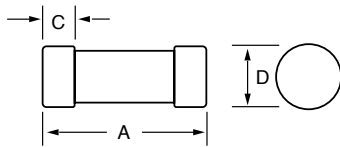

Fig. 1

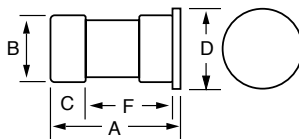

Fig. 2

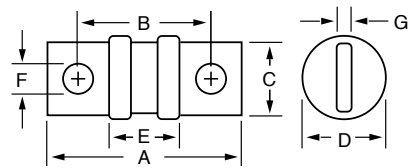
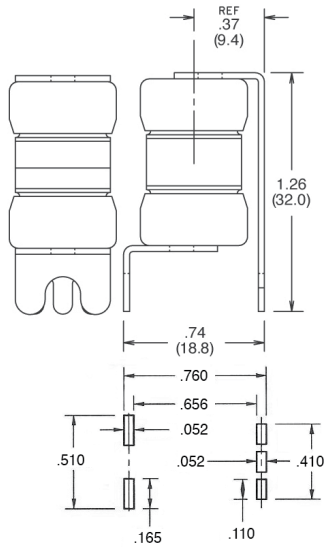

Fig. 3

PCB Mounting Options (JLLN 35–60 A Only)

**Vertical Mount
 JLLN-XV**



**Leaded
 JLLN-XL**

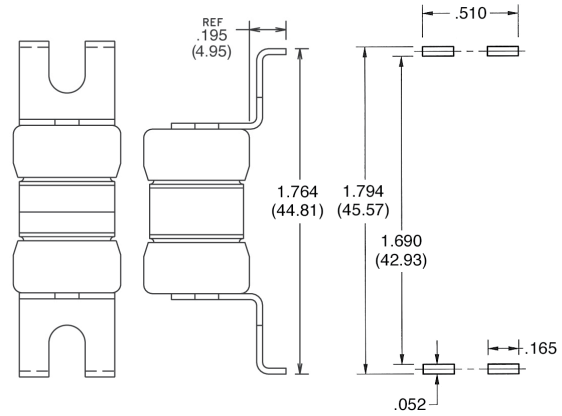

**Solder
 JLLN-XLS**

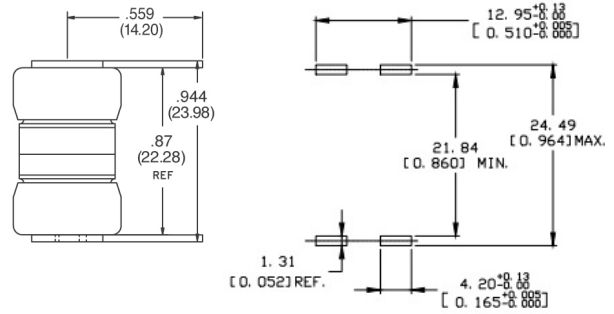

LSE Terminal Option

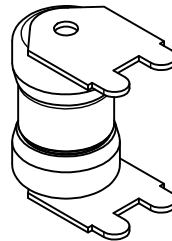
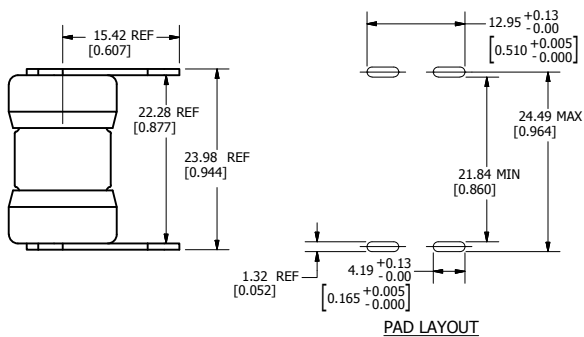

PAD LAYOUT

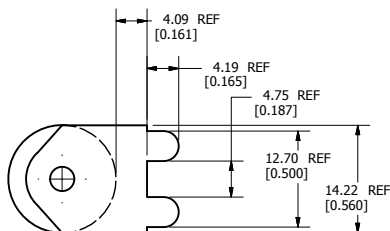

POWR-GARD® Fuse

CLASS T – JLLN / JLLS SERIES

Time Current Curve JLLN (1–10 A)

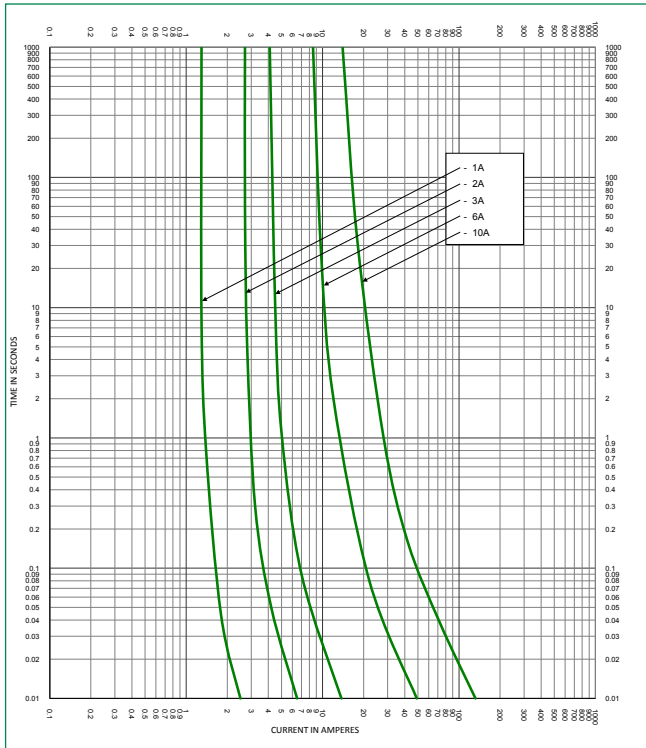

Time Current Curve JLLN (15–30 A)

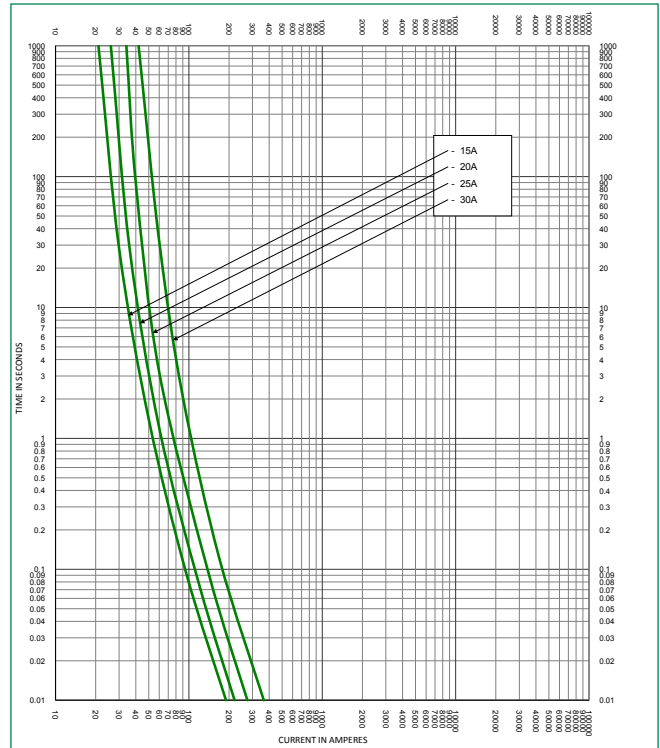

Time Current Curve JLLN (35–60 A)

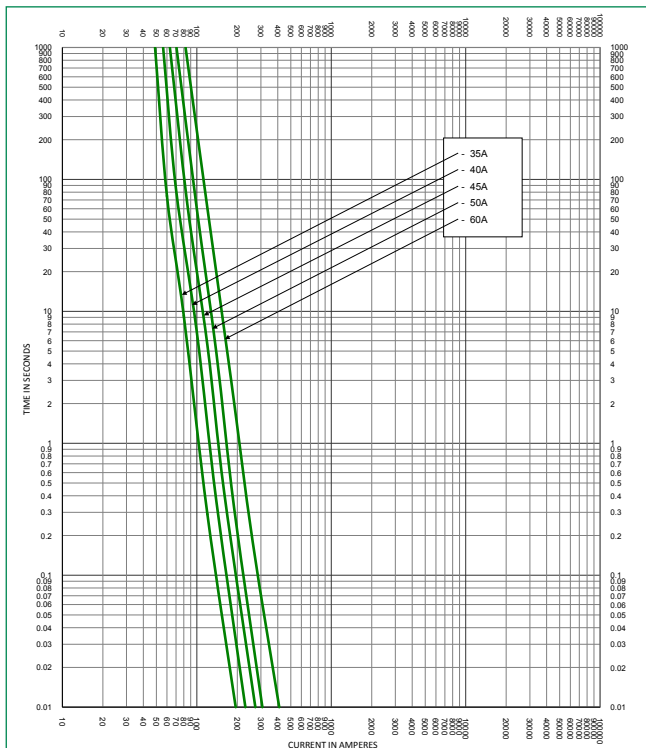

Time Current Curve JLLN (70–100 A)

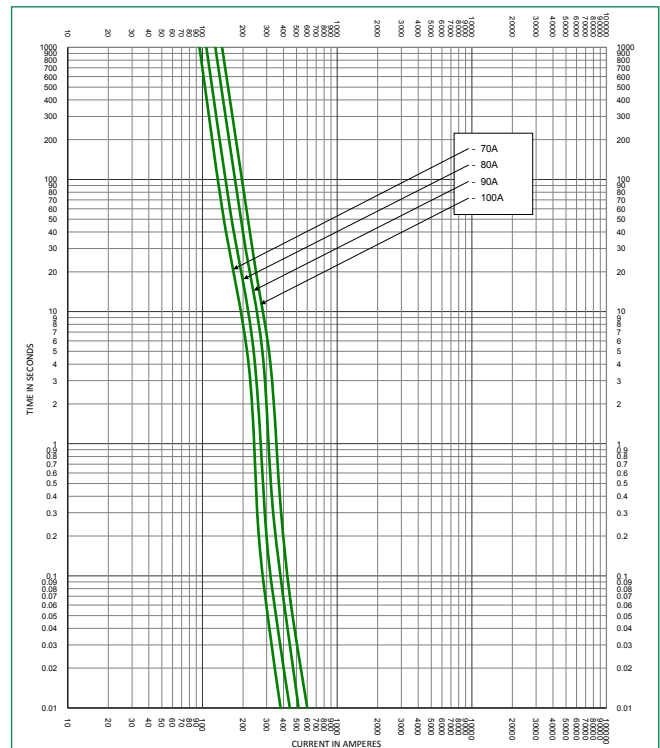

Time Current Curve JLLN (110–200 A)

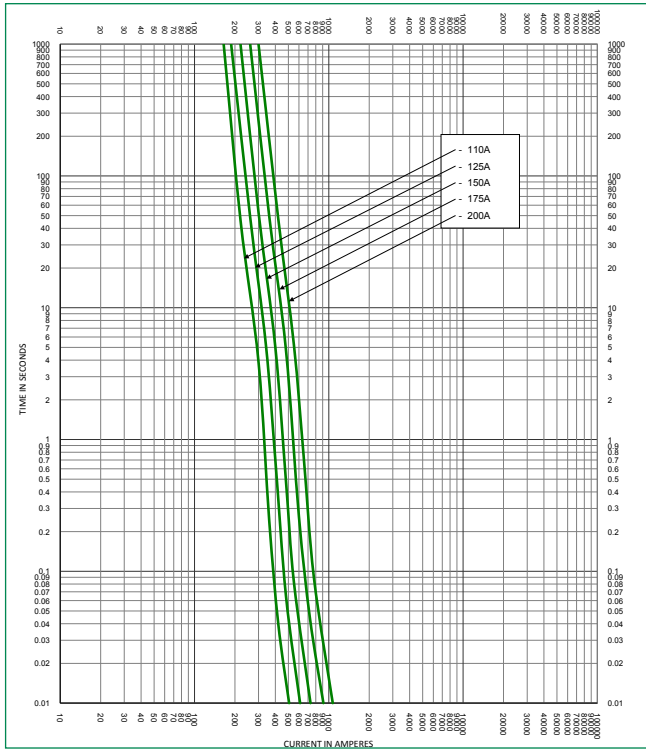

Time Current Curve JLLN (225–400 A)

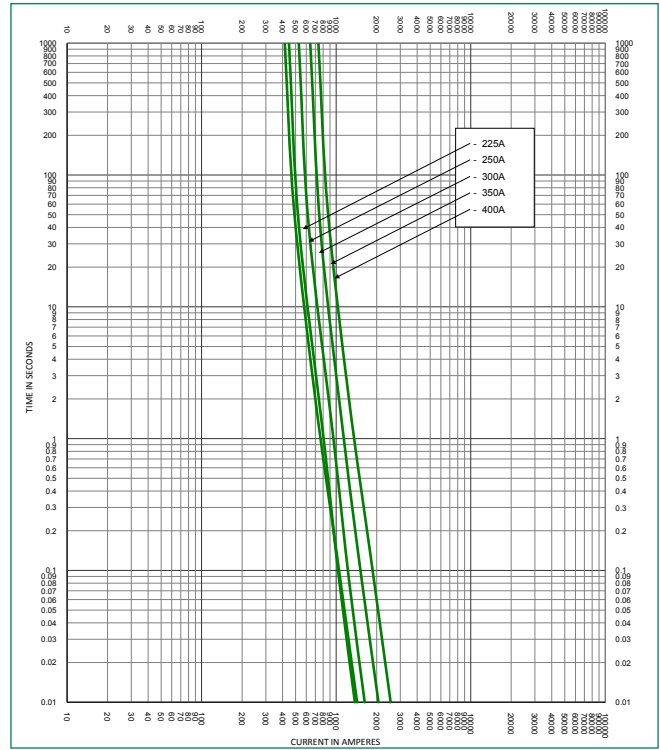

Time Current Curve JLLN (450–1200 A)

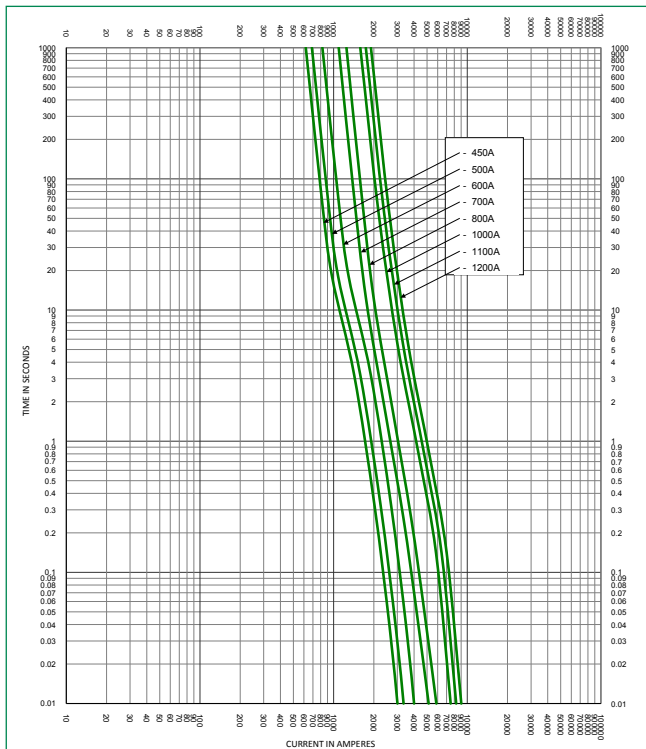

Time Current Curve JLLS (1–30 A)

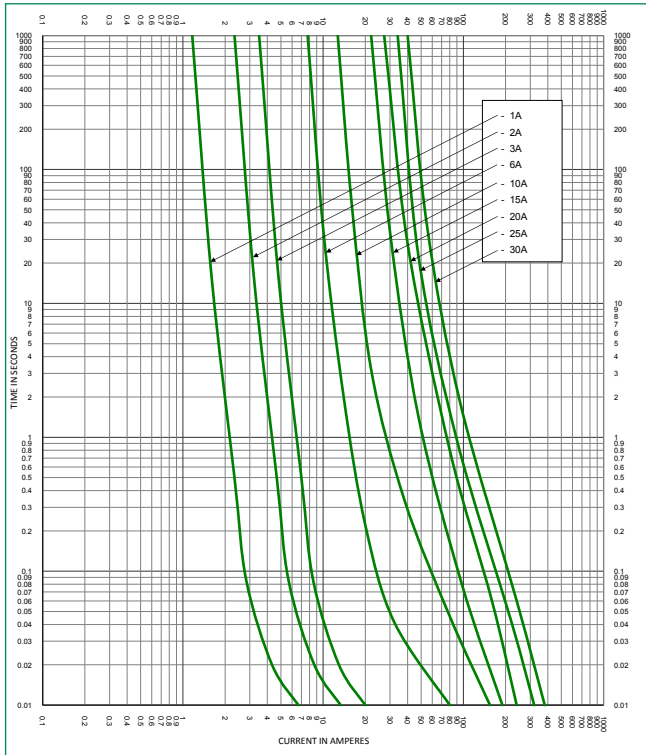

Time Current Curve JLLS (35–60 A)

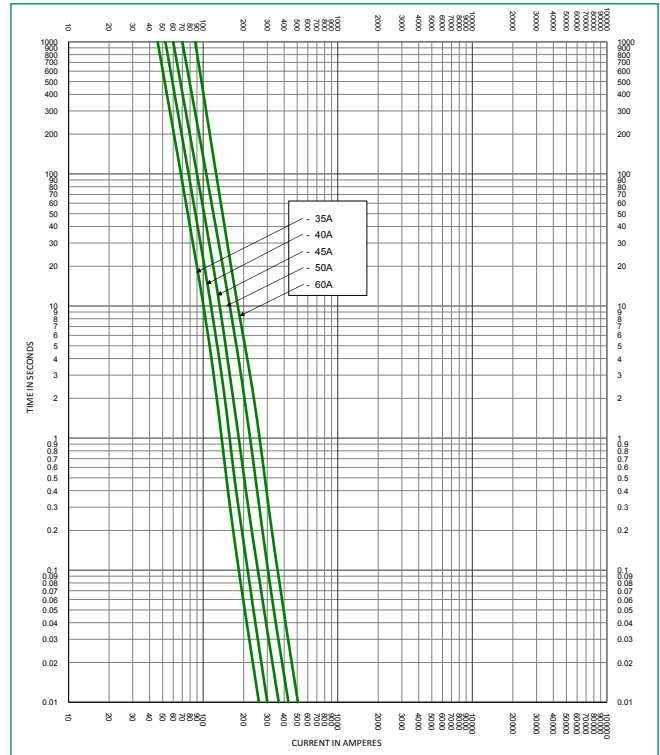

Time Current Curve JLLS (70–100 A)

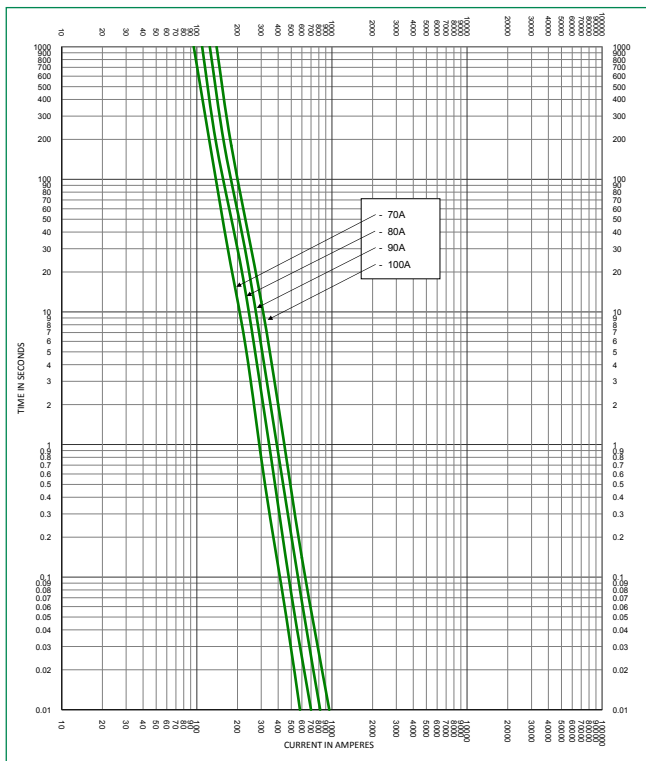

Time Current Curve JLLS (110–200 A)

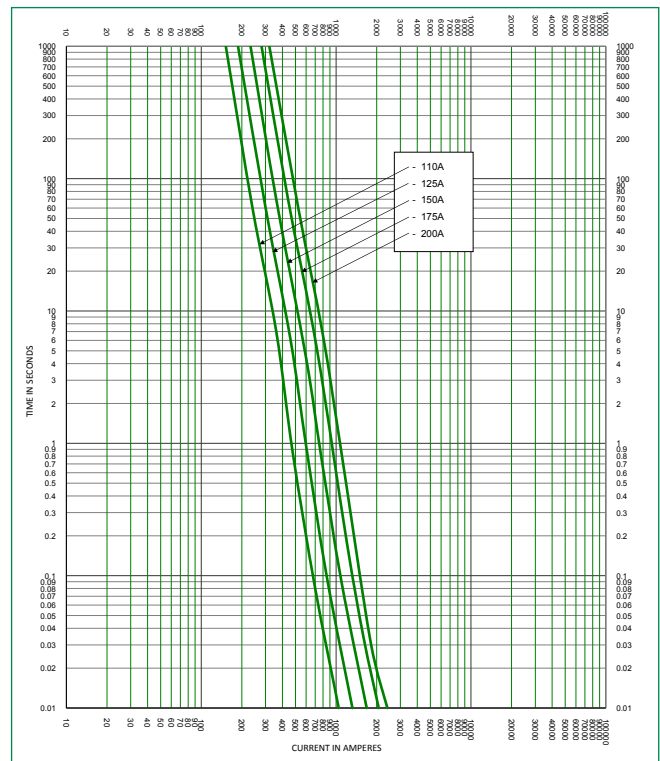

Time Current Curve JLLS (225–400A)

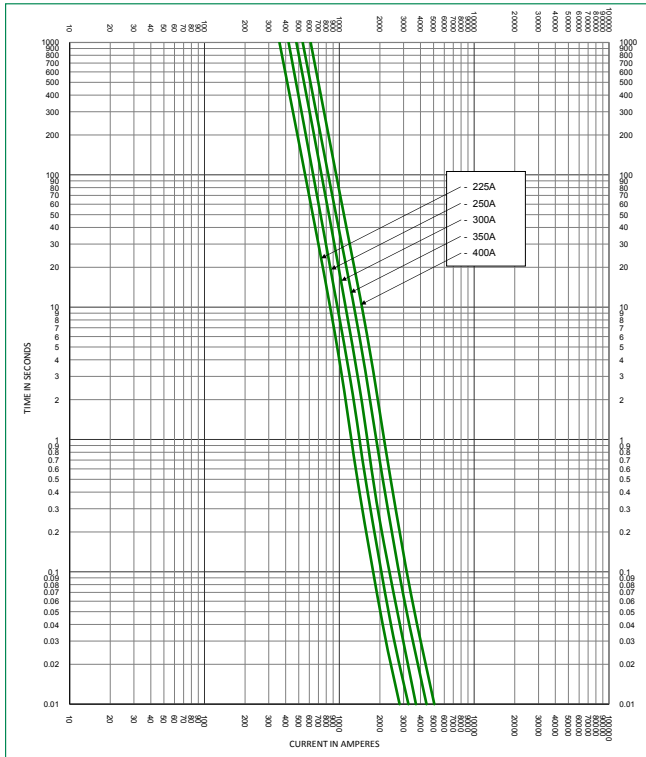

Time Current Curve JLLS (450–600A)

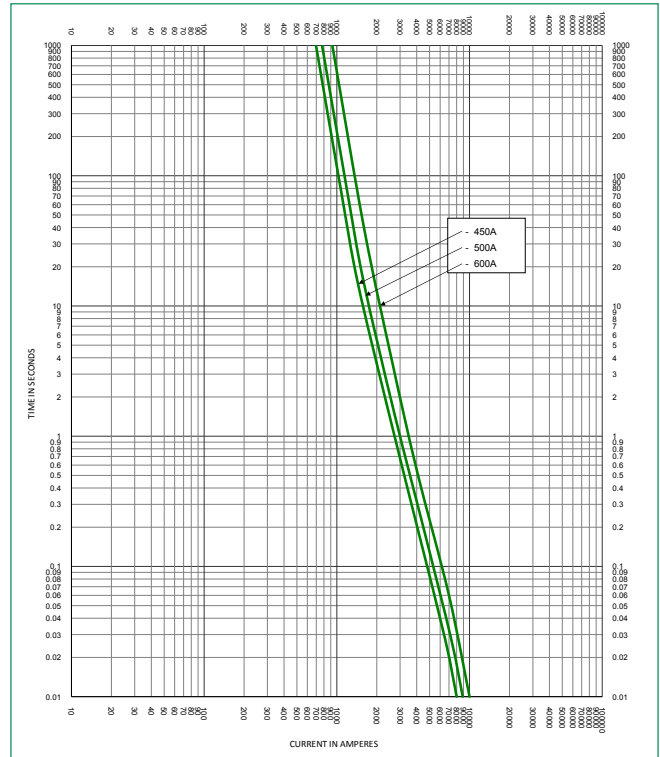

Time Current Curve JLLS (700–1200A)

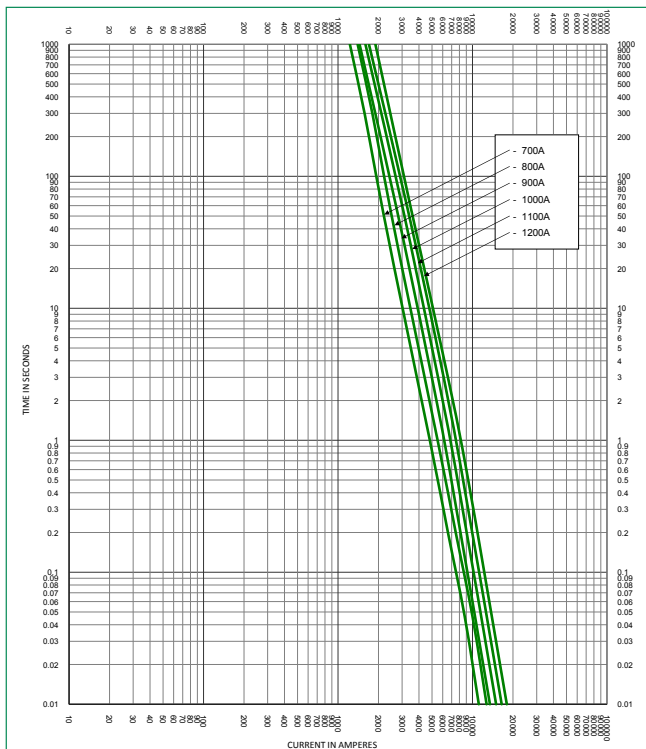

Peak Let-Through Curve and Current-Limiting Effects of JLLN (300 V) Fuses

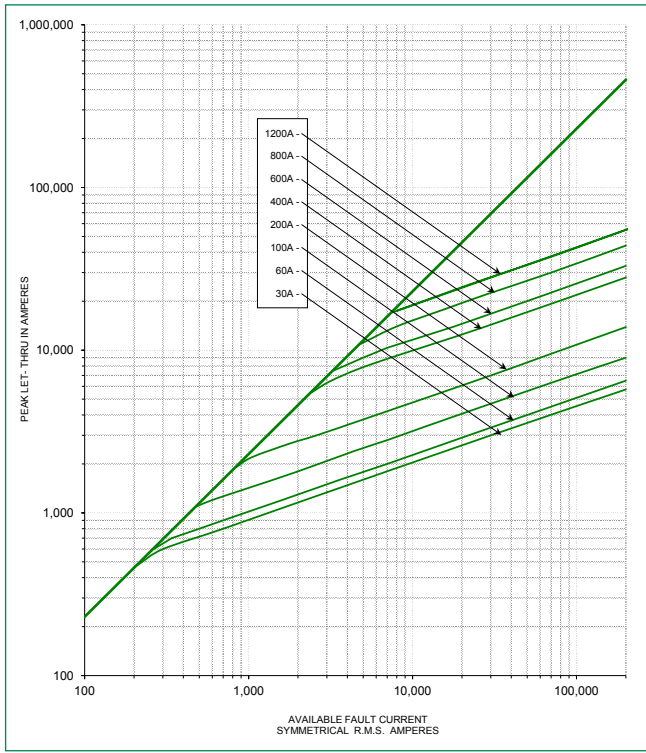

SHORT CIRCUIT CURRENT*	APPARENT RMS SYMMETRICAL CURRENT FOR VARIOUS FUSE RATINGS							
	30 A	60 A	100 A	200 A	400 A	600 A	800 A	1200 A
5,000	700	775	1,100	1,650	3,500	4,000	5,000	5,000
10,000	900	1,000	1,400	2,100	4,400	5,100	6,750	8,250
15,000	1,000	1,100	1,600	2,400	5,000	5,900	7,750	10,000
20,000	1,100	1,250	1,800	2,700	5,500	6,500	8,750	11,000
25,000	1,230	1,300	1,950	2,900	6,000	7,000	9,500	12,000
30,000	1,300	1,475	2,050	3,100	6,400	7,500	10,000	12,500
35,000	1,330	1,575	2,150	3,300	6,750	7,750	10,500	13,500
40,000	1,430	1,600	2,300	3,500	7,000	8,000	11,000	14,000
50,000	1,500	1,750	2,400	3,700	7,500	8,750	12,000	15,000
60,000	1,700	1,900	2,700	4,000	8,000	9,500	12,500	16,000
80,000	1,850	2,100	2,800	4,400	9,000	10,500	14,000	17,500
100,000	2,000	2,250	3,150	4,800	9,750	11,500	15,000	18,500
150,000	2,300	2,600	3,600	5,500	11,000	13,000	17,500	22,000
200,000	2,600	2,800	3,900	6,000	12,000	14,500	19,500	24,000

*Prospective RMS Symmetrical Amperes Short-Circuit Current
 Note: Data Derived from Peak Let-Through Curves

Peak Let-Through Curve and Current-Limiting Effects of JLLS (600 V) Fuses

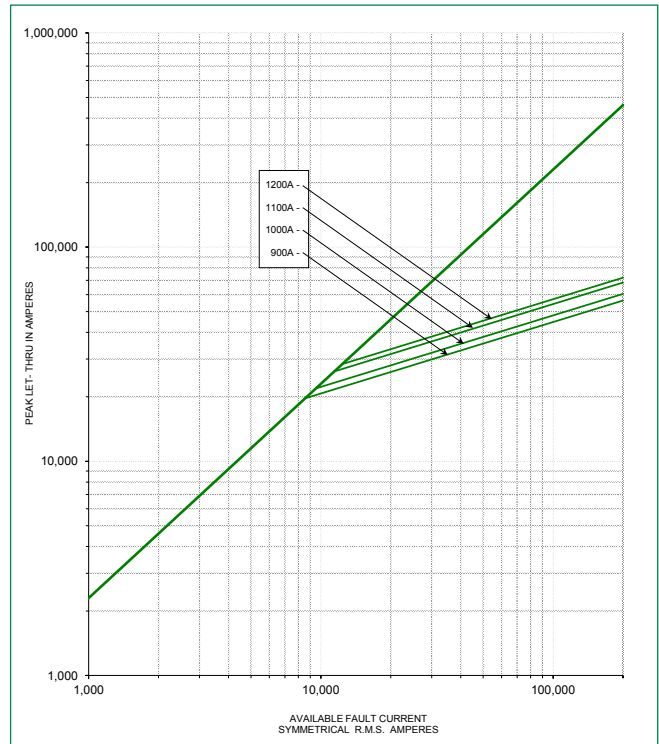
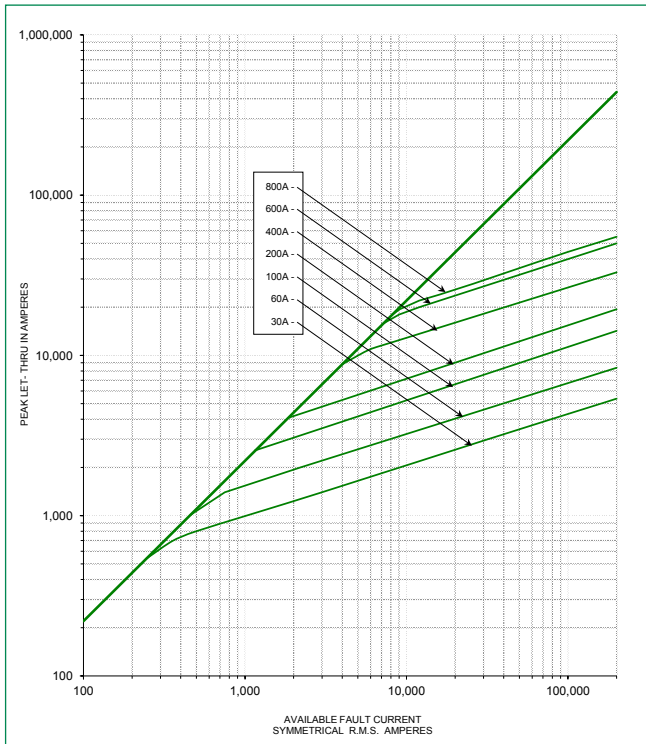

SHORT CIRCUIT CURRENT*	APPARENT RMS SYMMETRICAL CURRENT FOR VARIOUS FUSE RATINGS							
	30 A	60 A	100 A	200 A	400 A	600 A	800 A	1200 A
5,000	750	1,225	1,810	2,500	4,600	5,000	5,000	5,000
10,000	945	1,525	2,300	3,150	6,000	8,500	9,400	10,000
15,000	1,050	1,700	2,610	3,600	6,600	9,750	10,500	13,000
20,000	1,150	1,900	2,900	3,950	7,250	10,500	11,000	14,750
25,000	1,300	2,050	3,100	4,250	8,000	11,500	12,500	15,500
30,000	1,375	2,150	3,300	4,500	8,250	12,000	13,750	16,500
35,000	1,400	2,250	3,500	4,750	8,500	13,000	14,000	17,000
40,000	1,425	2,400	3,650	4,950	8,700	14,000	14,750	18,000
50,000	1,600	2,450	3,900	5,350	9,500	14,500	16,000	20,000
60,000	1,650	2,625	4,150	5,650	10,000	15,500	17,300	21,000
80,000	1,825	2,800	4,570	6,250	11,000	17,000	18,750	23,000
100,000	2,000	3,100	4,950	6,700	12,000	18,000	20,000	25,000
150,000	2,250	3,400	5,650	7,700	13,000	21,000	23,000	28,500
200,000	2,450	3,800	6,200	8,450	15,000	23,000	25,000	31,000

*Prospective RMS Symmetrical Amperes Short-Circuit Current
 Note: Data Derived from Peak Let-Through Curves

Disclaimer Notice - Information furnished is believed to be accurate and reliable. However, users should independently evaluate the suitability of and test each product selected for their own applications. Littelfuse products are not designed for, and may not be used in, all applications. Read complete Disclaimer Notice at www.littelfuse.com/product-disclaimer.