

# Insulated Gate Bi-Polar Transistor

## Type T0340VB45G

### Absolute Maximum Ratings

	VOLTAGE RATINGS	MAXIMUM LIMITS	UNITS
$V_{CES}$	Collector – emitter voltage	4500	V
$V_{DC\ link}$	Permanent DC voltage for 100 FIT failure rate.	2800	V
$V_{GES}$	Peak gate – emitter voltage	$\pm 20$	V

	RATINGS	MAXIMUM LIMITS	UNITS
$I_{C(DC)}$	DC collector current, IGBT	340	A
$I_{CRM}$	Repetitive peak collector current, $t_p=1ms$ , IGBT	680	A
$I_{F(DC)}$	Continuous DC forward current, Diode	340	A
$I_{FRM}$	Repetitive peak forward current, $t_p=1ms$ , Diode	680	A
$I_{FSM}$	Peak non-repetitive surge $t_p=10ms$ , $V_{RM}=60\%V_{RRM}$ , Diode (Note 4)	2060	A
$I_{FSM2}$	Peak non-repetitive surge $t_p=10ms$ , $V_{RM}\leq 10V$ , Diode (Note 4)	2280	A
$P_{MAX}$	Maximum power dissipation, IGBT (Note 2)	2.7	kW
$(di/dt)_{cr}$	Critical diode di/dt (note 3)	500	A/ $\mu s$
$T_j$	Operating temperature range.	-40 to +125	$^{\circ}C$
$T_{stg}$	Storage temperature range.	-40 to +125	$^{\circ}C$

Notes: -

- 1) Unless otherwise indicated  $T_j = 125^{\circ}C$ .
- 2)  $T_{sink} = 25^{\circ}C$ , double side cooled.
- 3) Maximum commutation loop inductance 200nH.
- 4) Half-sinewave,  $125^{\circ}C$   $T_j$  initial.

## Characteristics

### IGBT Characteristics

	PARAMETER	MIN	TYP	MAX	TEST CONDITIONS	UNITS
V <sub>CE(sat)</sub>	Collector – emitter saturation voltage	-	2.75	3.2	I <sub>C</sub> = 340A, V <sub>GE</sub> = 15V, T <sub>j</sub> = 25°C	V
		-	3.50	3.9	I <sub>C</sub> = 340A, V <sub>GE</sub> = 15V	V
V <sub>T0</sub>	Threshold voltage	-	-	2.18	Current range: 340 – 1020A	V
r <sub>T</sub>	Slope resistance	-	-	5.05		mΩ
V <sub>GE(TH)</sub>	Gate threshold voltage	-	5.2	-	V <sub>CE</sub> = V <sub>GE</sub> , I <sub>C</sub> = 35mA	V
I <sub>CES</sub>	Collector – emitter cut-off current	-	10	25	V <sub>CE</sub> = V <sub>CES</sub> , V <sub>GE</sub> = 0V	mA
I <sub>GES</sub>	Gate leakage current	-	-	±7	V <sub>GE</sub> = ±20V	µA
C <sub>ies</sub>	Input capacitance	-	60	-	V <sub>CE</sub> = 25V, V <sub>GE</sub> = 0V, f = 1MHz	nF
t <sub>d(on)</sub>	Turn-on delay time	-	3.7	-	I <sub>C</sub> = 340A, V <sub>CE</sub> = 2800V, di/dt = 500A/µs V <sub>GE</sub> = ±15V, L <sub>s</sub> = 200nH R <sub>g(ON)</sub> = 18Ω, R <sub>g(OFF)</sub> = 20Ω, C <sub>GE</sub> = 47nF Integral diode used as freewheel diode (Note 3 & 4)	µs
t <sub>r(V)</sub>	Rise time	-	3.2	-		µs
Q <sub>g(on)</sub>	Turn-on gate charge	-	6.5	-		µC
E <sub>on</sub>	Turn-on energy	-	2.9	-		J
t <sub>d(off)</sub>	Turn-off delay time	-	2.2	-		µs
t <sub>f(I)</sub>	Fall time	-	2.6	-		µs
Q <sub>g(off)</sub>	Turn-off gate charge	-	10	-		µC
E <sub>off</sub>	Turn-off energy	-	1.4	-		J
I <sub>SC</sub>	Short circuit current	-	1100	-		V <sub>GE</sub> = +15V, V <sub>CC</sub> = 2800V, V <sub>CEmax</sub> ≤ V <sub>CES</sub> , t <sub>p</sub> ≤ 10µs

### Diode Characteristics

	PARAMETER	MIN	TYP	MAX	TEST CONDITIONS	UNITS
V <sub>F</sub>	Forward voltage	-	3.3	3.6	I <sub>F</sub> = 340A, T <sub>j</sub> = 25°C	V
		-	3.45	3.8	I <sub>F</sub> = 340A	V
V <sub>T0</sub>	Threshold voltage	-	-	2.88	Current range 340-1020A	V
r <sub>T</sub>	Slope resistance	-	-	2.72		mΩ
I <sub>rm</sub>	Peak reverse recovery current	-	220	-	I <sub>F</sub> = 340A, V <sub>GE</sub> = -15V, di/dt = 500A/µs	A
Q <sub>rr</sub>	Recovered charge	-	500	-		µC
t <sub>rr</sub>	Reverse recovery time, 50% chord	-	3.2	-		µs
E <sub>r</sub>	Reverse recovery energy	-	0.4	-		J

### Thermal Characteristics

	PARAMETER	MIN	TYP	MAX	TEST CONDITIONS	UNITS
R <sub>thJK</sub>	Thermal resistance junction to sink, IGBT	-	-	36.4	Double side cooled	K/kW
		-	-	94.3	Collector side cooled	K/kW
		-	-	59.4	Emitter side cooled	K/kW
R <sub>thJK</sub>	Thermal resistance junction to sink, Diode	-	-	57.6	Double side cooled	K/kW
		-	-	88.2	Cathode side cooled	K/kW
		-	-	166	Anode side cooled	K/kW
F	Mounting force	12	-	16	Note 2	kN
W <sub>t</sub>	Weight	-	0.65	-		kg

Notes:-

- 1) Unless otherwise indicated T<sub>j</sub> = 125°C.
- 2) Consult application note 2008AN01 for detailed mounting requirements
- 3) C<sub>GE</sub> is additional gate – emitter capacitance added to output of gate drive
- 4) Figures 6 to 9 are obtained using integral diode as freewheeling diode

**Curves**

Figure 1 – Typical collector-emitter saturation voltage characteristics

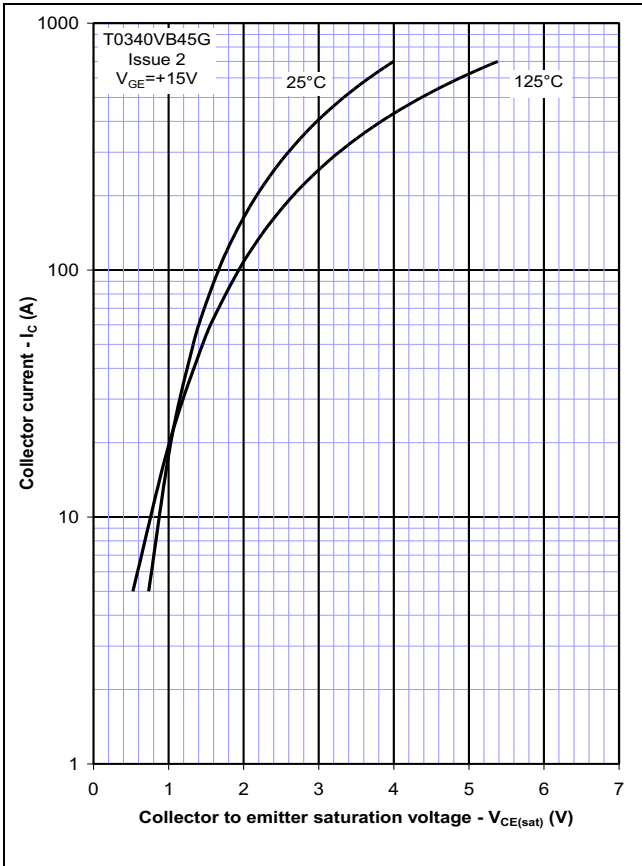

Figure 2 – Typical output characteristic

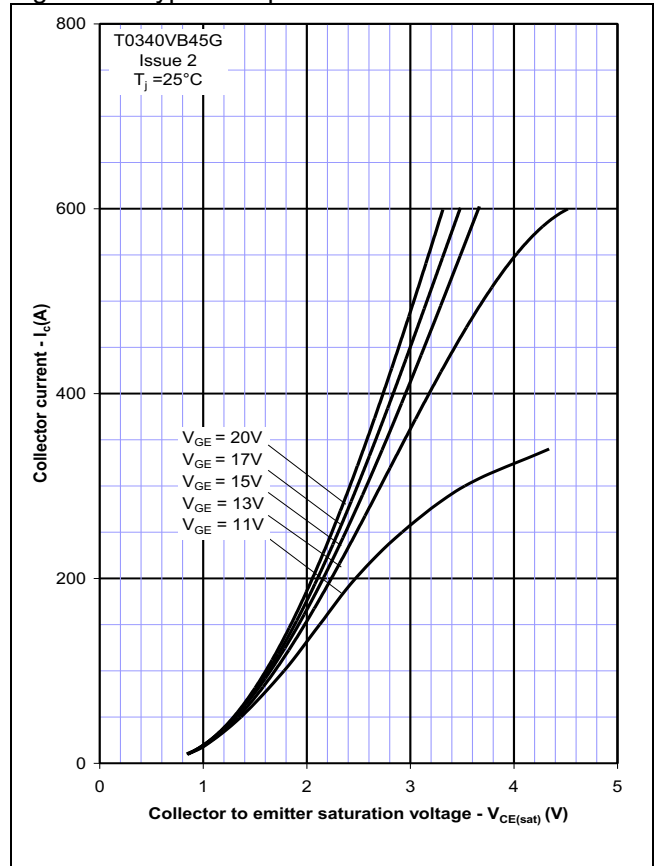

Figure 3 – Typical output characteristic

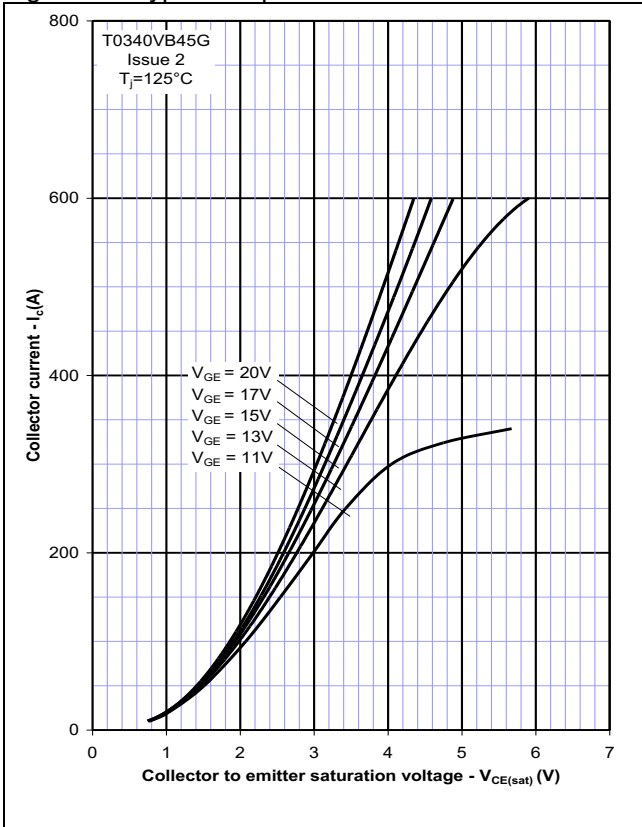

Figure 4 – Typical turn-on delay time vs gate resistance

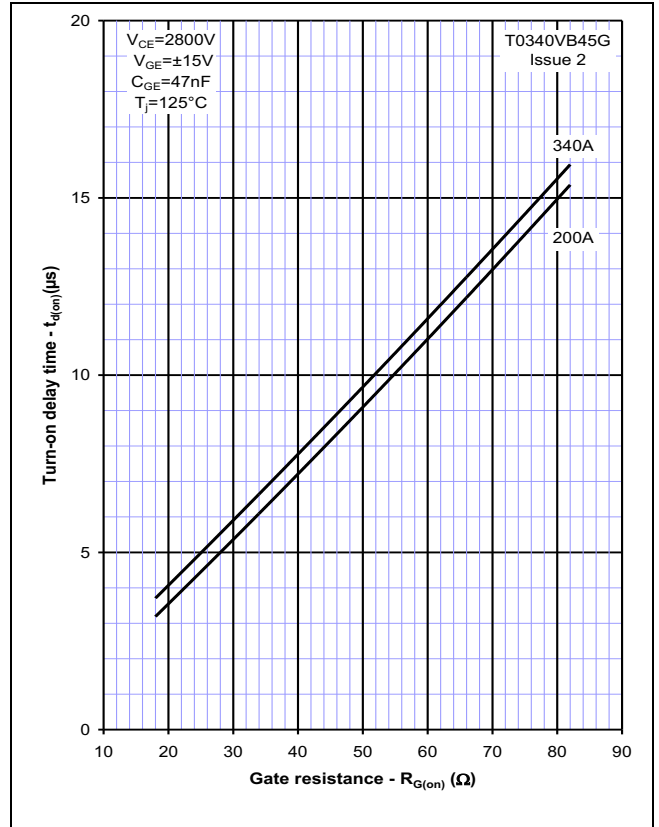

Figure 5 – Typical turn-off delay time vs. gate resistance

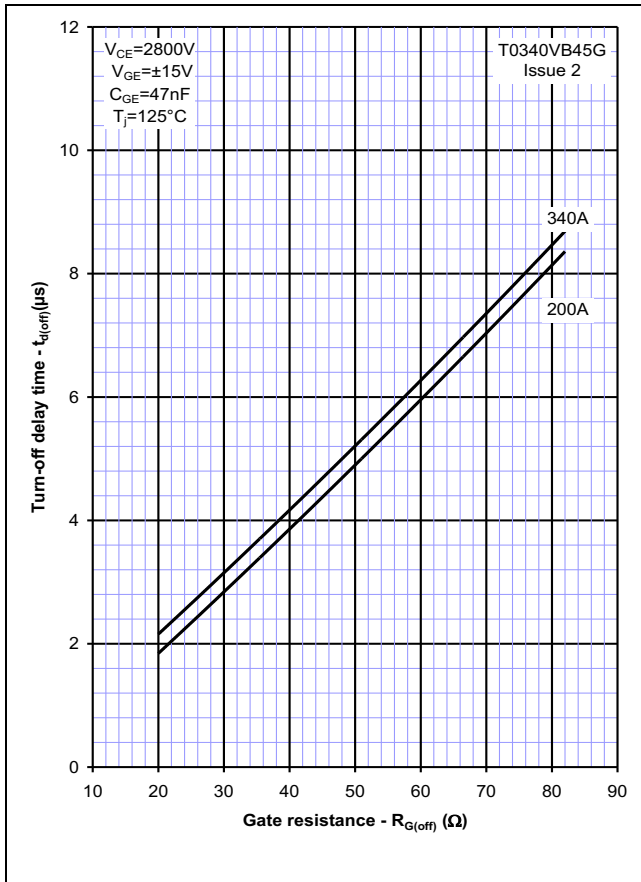

Figure 6 – Typical turn-on energy vs. collector current

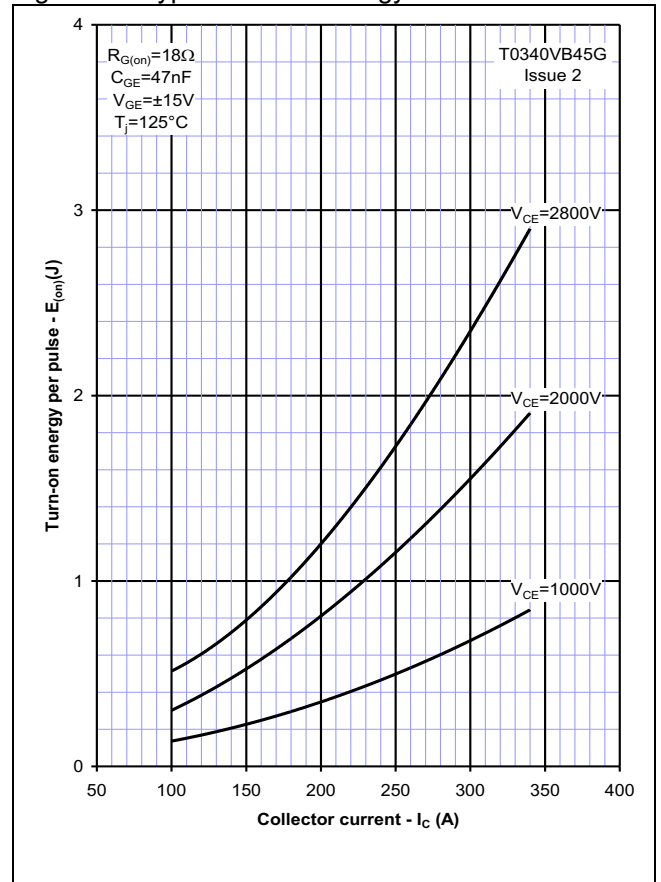

Figure 7 – Typical turn-on energy vs. di/dt

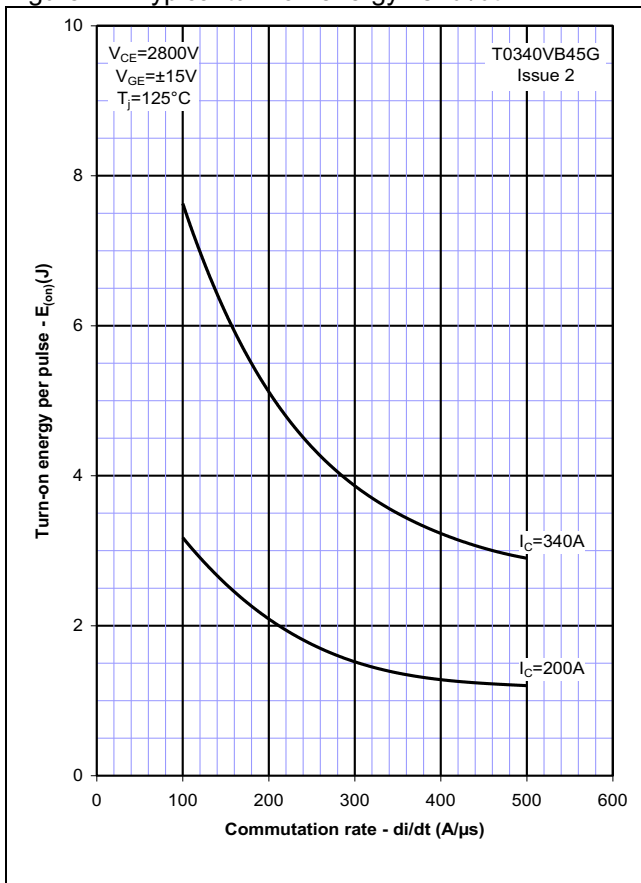

Figure 8 – Typical turn-off energy vs. collector current

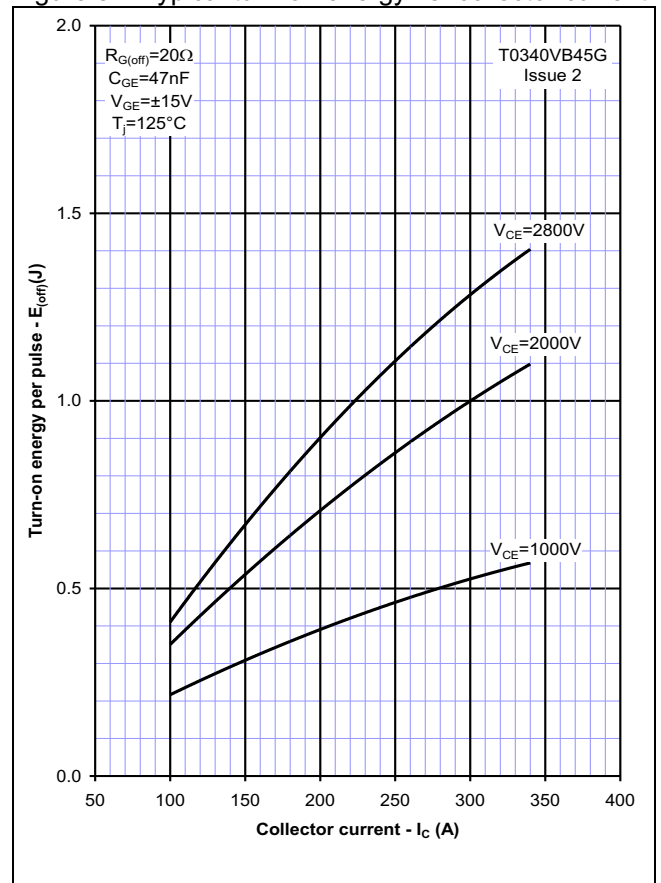

Figure 9 – Turn-off energy vs voltage

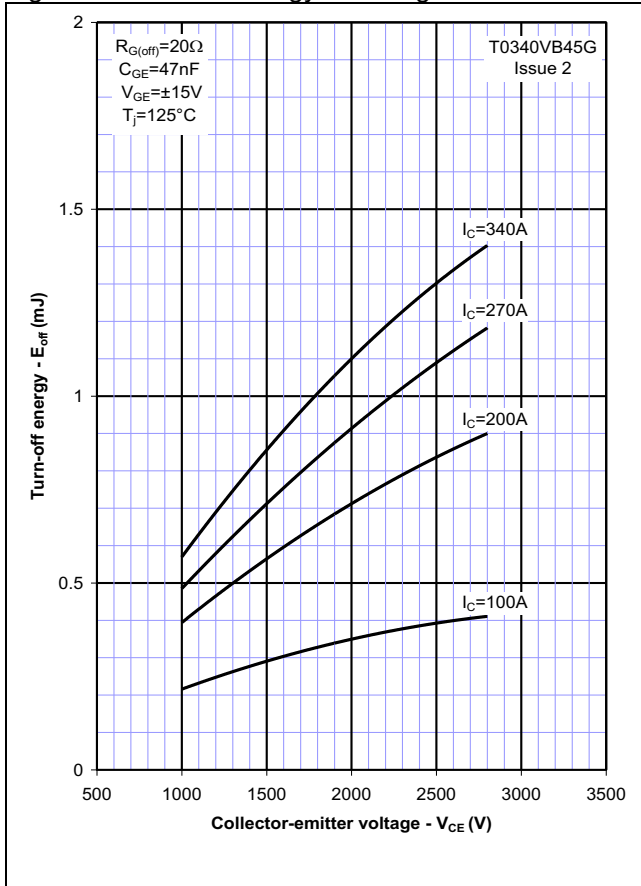

Figure 10 – Safe operating area

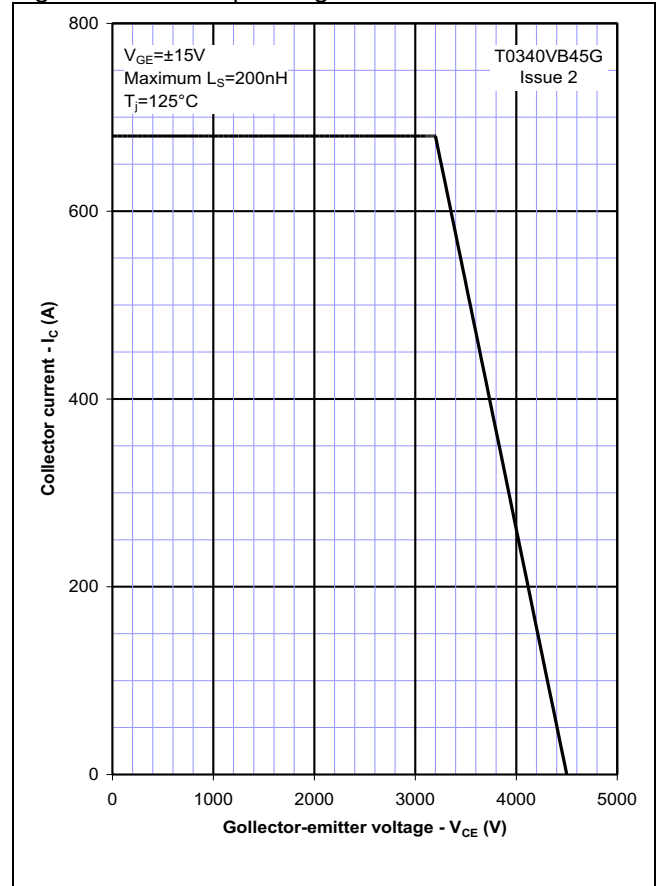

Figure 11 – Typical diode forward characteristics

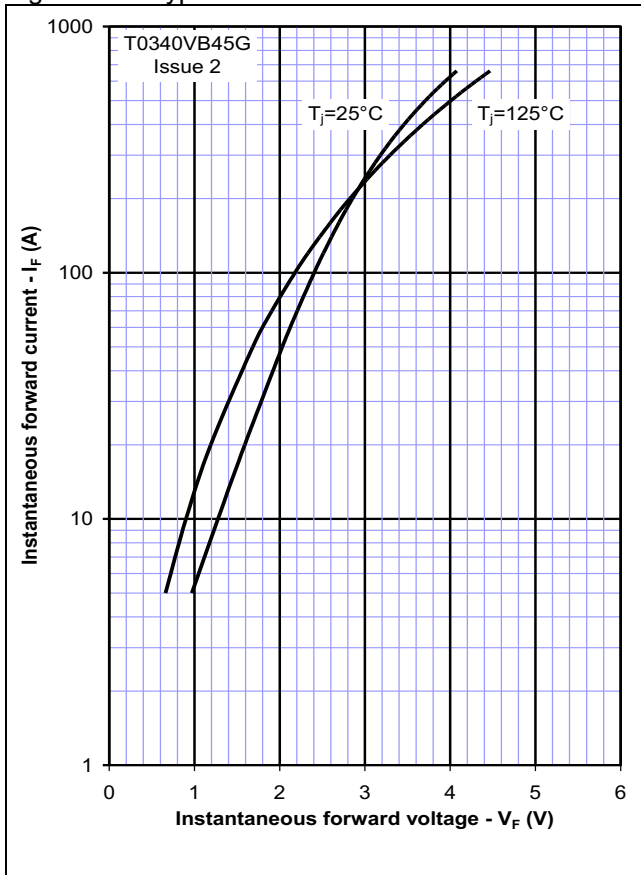

Figure 12 – Typical recovered charge

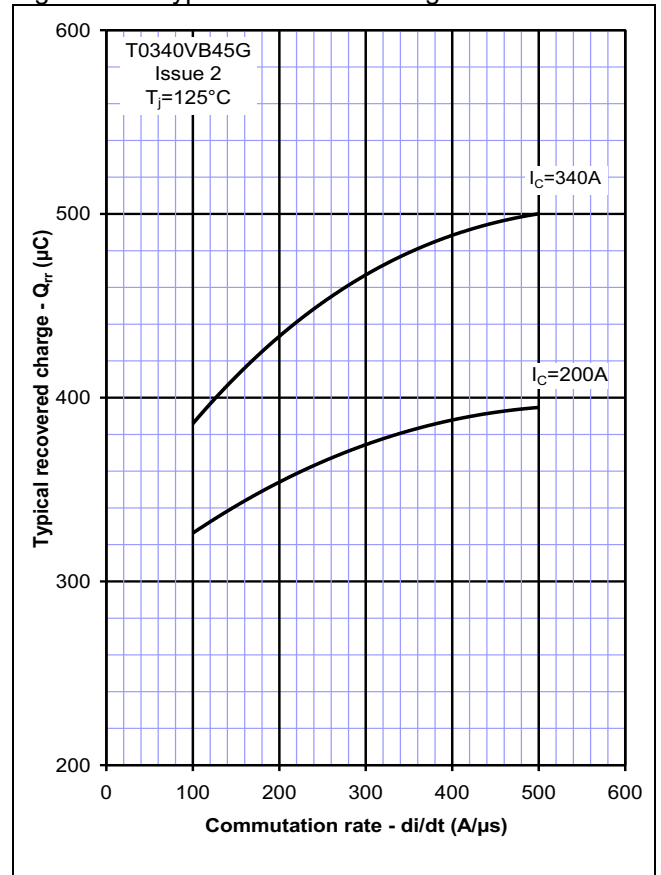

Figure 13 – Typical reverse recovery current

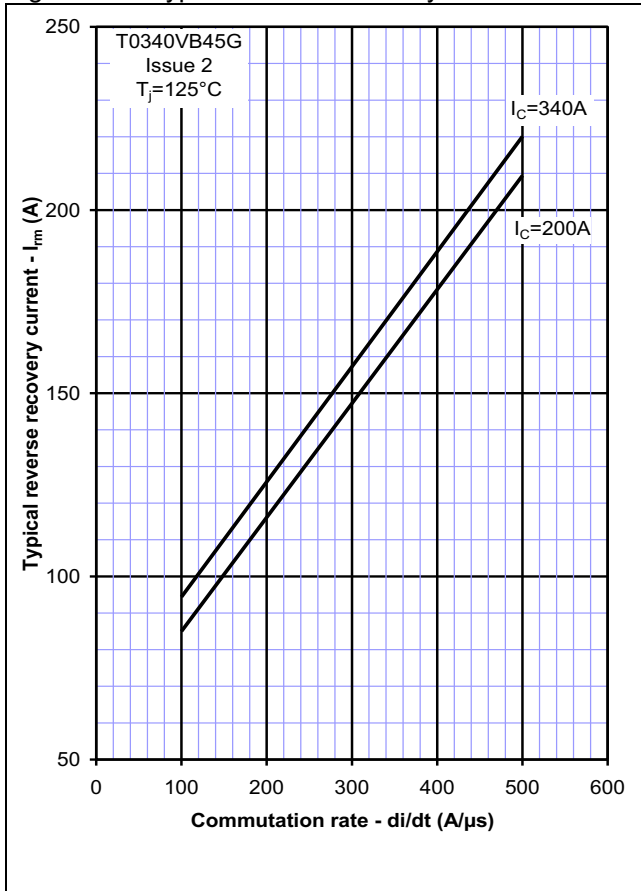

Figure 14 – Typical reverse recovery time

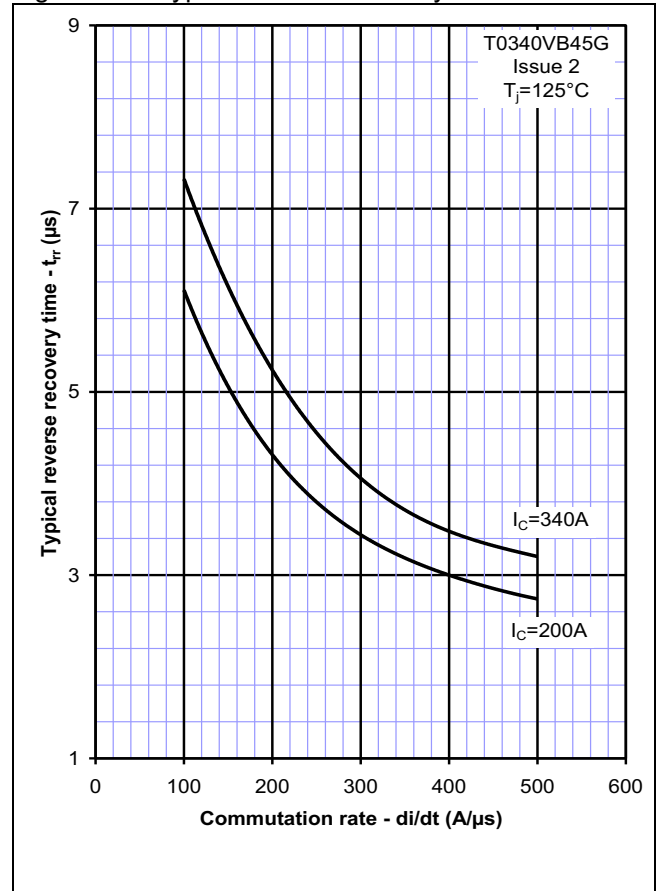

Figure 15 – Transient thermal impedance (IGBT)

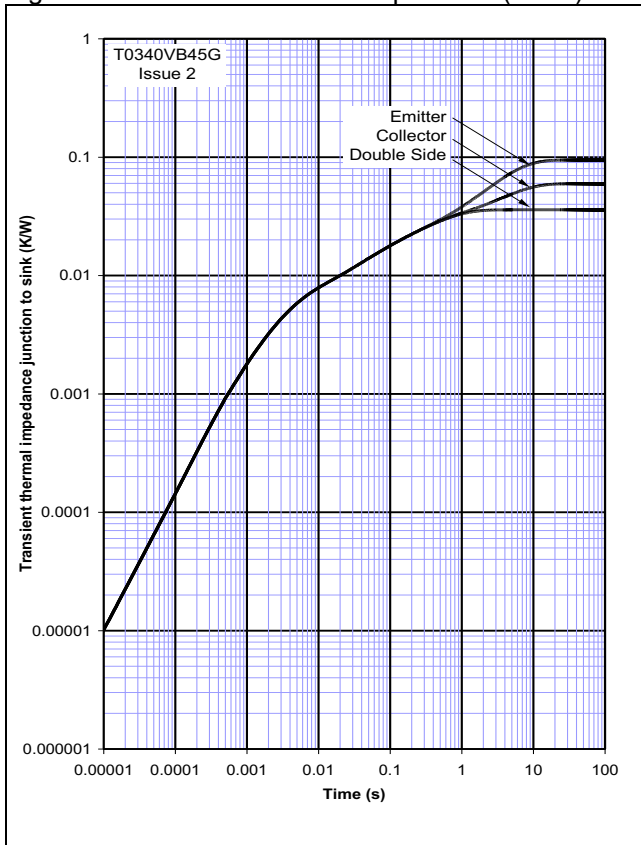
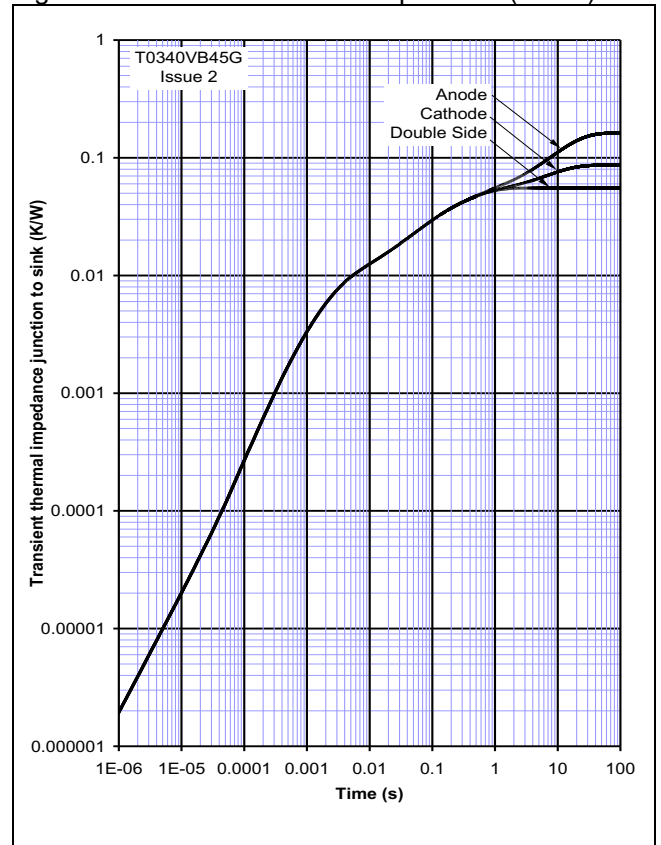
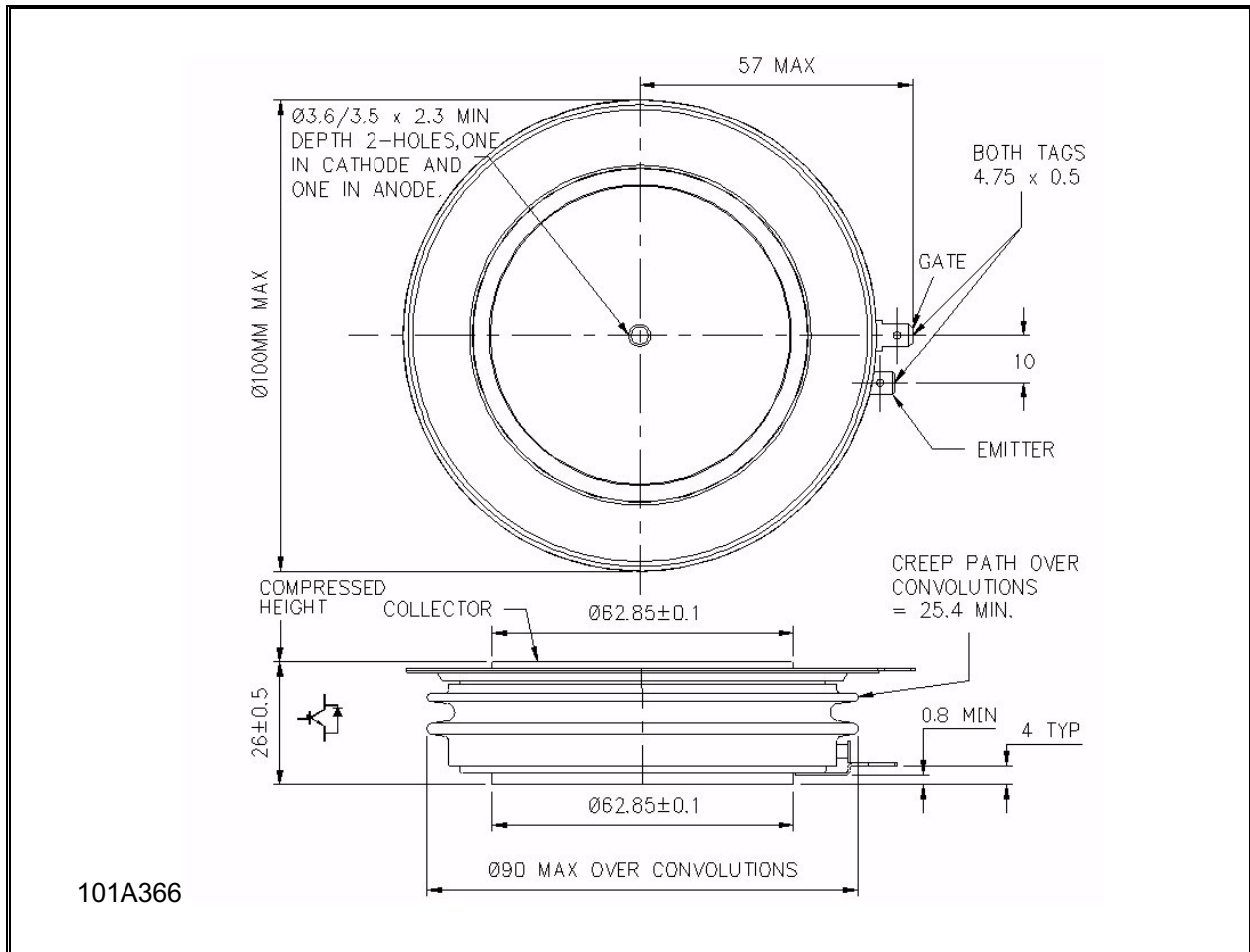

Figure 16 – Transient thermal impedance (Diode)



**Outline Drawing & Ordering Information**



<b>ORDERING INFORMATION</b> (Please quote 10 digit code as below)			
<b>T0340</b>	<b>VB</b>	<b>45</b>	<b>G</b>
Fixed type Code	Fixed Outline Code	Voltage Grade $V_{CES}/100$ 45	Fixed format code

Typical order code: T0340VB45G ( $V_{CES} = 4500\text{V}$ )

**IXYS Semiconductor GmbH**  
Edisonstraße 15  
D-68623 Lampertheim  
Tel: +49 6206 503-0  
Fax: +49 6206 503-627  
E-mail: [marcom@ixys.de](mailto:marcom@ixys.de)



**IXYS UK Westcode Ltd**  
Langley Park Way, Langley Park,  
Chippenham, Wiltshire, SN15 1GE.  
Tel: +44 (0)1249 444524  
Fax: +44 (0)1249 659448  
E-mail: [sales@ixysuk.com](mailto:sales@ixysuk.com)

**IXYS Corporation**  
1590 Buckeye Drive  
Milpitas CA 95035-7418  
Tel: +1 (408) 457 9000  
Fax: +1 (408) 496 0670  
E-mail: [sales@ixys.net](mailto:sales@ixys.net)

[www.ixysuk.com](http://www.ixysuk.com)

[www.ixys.net](http://www.ixys.net)

**IXYS Long Beach**  
IXYS Long Beach, Inc  
2500 Mira Mar Ave, Long Beach  
CA 90815  
Tel: +1 (562) 296 6584  
Fax: +1 (562) 296 6585  
E-mail: [service@ixyslongbeach.com](mailto:service@ixyslongbeach.com)

The information contained herein is confidential and is protected by Copyright. The information may not be used or disclosed except with the written permission of and in the manner permitted by the proprietors IXYS UK Westcode Ltd.

© IXYS UK Westcode Ltd.

In the interest of product improvement, IXYS UK Westcode Ltd reserves the right to change specifications at any time without prior notice.

Devices with a suffix code (2-letter, 3-letter or letter/digit/letter combination) added to their generic code are not necessarily subject to the conditions and limits contained in this report.



---

Disclaimer Notice - Information furnished is believed to be accurate and reliable. However, users should independently evaluate the suitability of and test each product selected for their own applications. Littelfuse products are not designed for, and may not be used in, all applications. Read complete Disclaimer Notice at [www.littelfuse.com/disclaimer-electronics](http://www.littelfuse.com/disclaimer-electronics).