

**XPT™ 650V IGBT
GenX3™ w/ Diode**
**IXYK100N65C3D1
IXYX100N65C3D1**

$$V_{CES} = 650V$$

$$I_{C110} = 100A$$

$$V_{CE(sat)} \leq 2.3V$$

$$t_{fi(typ)} = 60ns$$

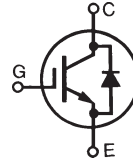
 Extreme Light Punch Through
IGBT for 20-60kHz Switching

Symbol	Test Conditions	Maximum Ratings	
V_{CES}	$T_J = 25^\circ C$ to $175^\circ C$	650	V
V_{CGR}	$T_J = 25^\circ C$ to $175^\circ C$, $R_{GE} = 1M\Omega$	650	V
V_{GES}	Continuous	± 20	V
V_{GEM}	Transient	± 30	V
I_{C25}	$T_C = 25^\circ C$ (Chip Capability)	200	A
I_{LRMS}	Terminal Current Limit	160	A
I_{C110}	$T_C = 110^\circ C$	100	A
I_{F110}	$T_C = 110^\circ C$	67	A
I_{CM}	$T_C = 25^\circ C$, 1ms	420	A
I_A	$T_C = 25^\circ C$	50	A
E_{AS}	$T_C = 25^\circ C$	600	mJ
SSOA (RBSOA)	$V_{GE} = 15V$, $T_{VJ} = 150^\circ C$, $R_G = 3\Omega$ Clamped Inductive Load	$I_{CM} = 200$ $@V_{CE} \leq V_{CES}$	A
t_{sc} (SCSOA)	$V_{GE} = 15V$, $V_{CE} = 360V$, $T_J = 150^\circ C$ $R_G = 10\Omega$, Non Repetitive	7	μs
P_C	$T_C = 25^\circ C$	830	W
T_J		-55 ... +175	$^\circ C$
T_{JM}		175	$^\circ C$
T_{stg}		-55 ... +175	$^\circ C$
T_L	Maximum Lead Temperature for Soldering	300	$^\circ C$
T_{SOLD}	1.6 mm (0.062in.) from Case for 10s	260	$^\circ C$
M_d	Mounting Torque (TO-264)	1.13/10	Nm/lb.in
F_c	Mounting Force (PLUS247)	20..120 / 4.5..27	N/lb
Weight	TO-264	10	g
	PLUS247	6	g

TO-264 (IXYK)

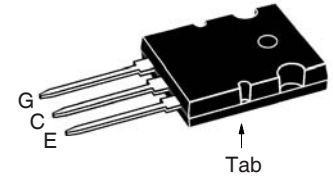

PLUS247 (IXYX)

 G = Gate
C = Collector

 E = Emitter
Tab = Collector

Features

- International Standard Packages
- Optimized for 20-60kHz Switching
- Square RBSOA
- Avalanche Rated
- Short Circuit Capability
- Anti-Parallel Ultra Fast Diode
- High Current Handling Capability

Advantages

- High Power Density
- Low Gate Drive Requirement

Applications

- Power Inverters
- UPS
- Motor Drives
- SMPS
- PFC Circuits
- Battery Chargers
- Welding Machines
- Lamp Ballasts

Symbol	Test Conditions ($T_J = 25^\circ C$, Unless Otherwise Specified)	Characteristic Values		
		Min.	Typ.	Max.
BV_{CES}	$I_C = 250\mu A$, $V_{GE} = 0V$	650		V
$V_{GE(th)}$	$I_C = 250\mu A$, $V_{CE} = V_{GE}$	3.5		6.0 V
I_{CES}	$V_{CE} = V_{CES}$, $V_{GE} = 0V$ $T_J = 150^\circ C$			50 μA 3 mA
I_{GES}	$V_{CE} = 0V$, $V_{GE} = \pm 20V$			± 100 nA
$V_{CE(sat)}$	$I_C = 70A$, $V_{GE} = 15V$, Note 1 $T_J = 150^\circ C$		1.8 2.2	V V

Symbol Test Conditions		Characteristic Values		
(T _J = 25°C Unless Otherwise Specified)		Min.	Typ.	Max.
g_{fs}	I _C = 60A, V _{CE} = 10V, Note 1	30	55	S
C_{ies}	V _{CE} = 25V, V _{GE} = 0V, f = 1MHz		4800	pF
C_{oes}			475	pF
C_{res}			102	pF
Q_{g(on)}	I _C = 100A, V _{GE} = 15V, V _{CE} = 0.5 • V _{CES}		172	nC
Q_{ge}			30	nC
Q_{gc}			80	nC
t_{d(on)}	Inductive load, T_J = 25°C I _C = 50A, V _{GE} = 15V V _{CE} = 400V, R _G = 3Ω Note 2		23	ns
t_{ri}			42	ns
E_{on}			1.30	mJ
t_{d(off)}			107	ns
t_{fi}			60	ns
E_{off}			0.83	1.30 mJ
t_{d(on)}	Inductive load, T_J = 150°C I _C = 50A, V _{GE} = 15V V _{CE} = 400V, R _G = 3Ω Note 2		24	ns
t_{ri}			38	ns
E_{on}			2.55	mJ
t_{d(off)}			134	ns
t_{fi}			66	ns
E_{off}			1.15	mJ
R_{thJC}				0.18 °C/W
R_{thCS}		0.15		°C/W

TO-264 Outline

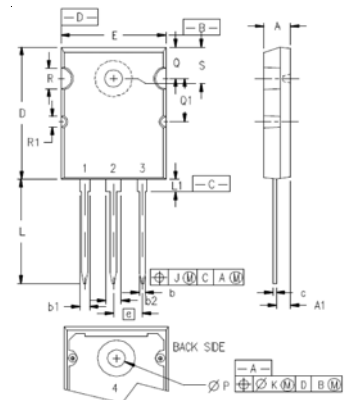

Terminals: 1 = Gate
2,4 = Collector
3 = Emitter

SYM	INCHES		MILLIMETERS	
	MIN	MAX	MIN	MAX
A	.185	.209	4.70	5.31
A1	.102	.118	2.59	3.00
b	.037	.055	0.94	1.40
b1	.087	.102	2.21	2.59
b2	.110	.126	2.79	3.20
c	.017	.029	0.43	0.74
D	1.007	1.047	25.58	26.59
E	.760	.799	19.30	20.29
e	.215BSC		5.46 BSC	
J	.000	.010	0.00	0.25
K	.000	.010	0.00	0.25
L	.779	.842	19.79	21.39
L1	.087	.102	2.21	2.59
ØP	.122	.138	3.10	3.51
Q	.240	.256	6.10	6.50
Q1	.330	.346	8.38	8.79
ØR	.155	.187	3.94	4.75
ØR1	.085	.093	2.16	2.36
S	.243	.253	6.17	6.43

Reverse Diode (FRED)

Symbol Test Conditions		Characteristic Values		
(T _J = 25°C Unless Otherwise Specified)		Min.	Typ.	Max.
V_F	I _F = 100A, V _{GE} = 0V, Note 1 T _J = 150°C		1.7 1.4	V V
I_{RM}	I _F = 100A, V _{GE} = 0V, T _J = 150°C, -di _F /dt = 700A/µs, V _R = 400V		42	A
t_{rr}			150	ns
R_{thJC}				0.36 °C/W

Notes:

1. Pulse test, t ≤ 300µs, duty cycle, d ≤ 2%.
2. Switching times & energy losses may increase for higher V_{CE}(clamp), T_J or R_G.

ADVANCE TECHNICAL INFORMATION

The product presented herein is under development. The Technical Specifications offered are derived from a subjective evaluation of the design, based upon prior knowledge and experience, and constitute a "considered reflection" of the anticipated result. IXYS reserves the right to change limits, test conditions, and dimensions without notice.

PLUS247™ Outline

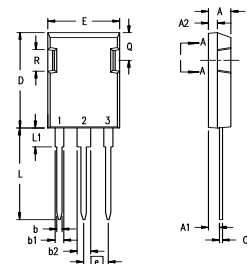

Terminals: 1 - Gate
2 - Collector
3 - Emitter

Dim.	Millimeter		Inches	
	Min.	Max.	Min.	Max.
A	4.83	5.21	.190	.205
A ₁	2.29	2.54	.090	.100
A ₂	1.91	2.16	.075	.085
b	1.14	1.40	.045	.055
b ₁	1.91	2.13	.075	.084
b ₂	2.92	3.12	.115	.123
C	0.61	0.80	.024	.031
D	20.80	21.34	.819	.840
E	15.75	16.13	.620	.635
e	5.45 BSC		.215 BSC	
L	19.81	20.32	.780	.800
L1	3.81	4.32	.150	.170
Q	5.59	6.20	.220	0.244
R	4.32	4.83	.170	.190

IXYS Reserves the Right to Change Limits, Test Conditions, and Dimensions.

IXYS MOSFETs and IGBTs are covered by one or more of the following U.S. patents:	4,835,592	4,931,844	5,049,961	5,237,481	6,162,665	6,404,065 B1	6,683,344	6,727,585	7,005,734 B2	7,157,338B2
	4,860,072	5,017,508	5,063,307	5,381,025	6,259,123 B1	6,534,343	6,710,405 B2	6,759,692	7,063,975 B2	
	4,881,106	5,034,796	5,187,117	5,486,715	6,306,728 B1	6,583,505	6,710,463	6,771,478 B2	7,071,537	

Fig. 1. Output Characteristics @ $T_J = 25^\circ\text{C}$

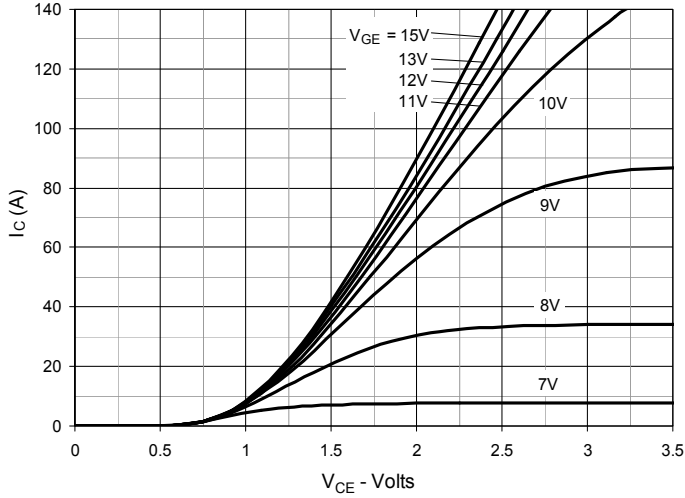

Fig. 2. Extended Output Characteristics @ $T_J = 25^\circ\text{C}$

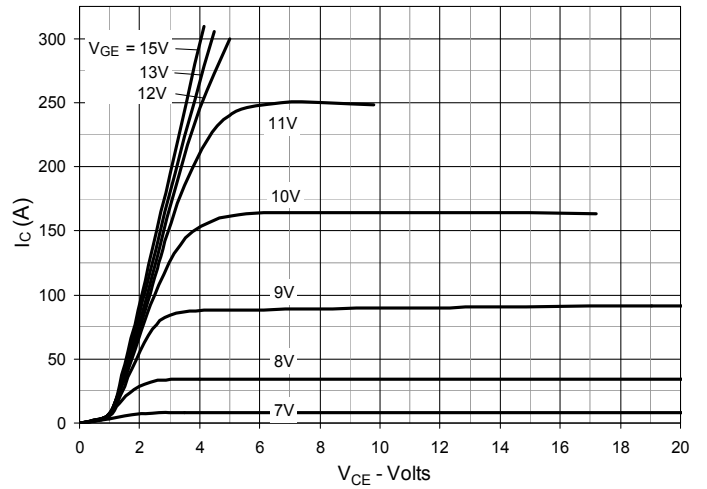

Fig. 3. Output Characteristics @ $T_J = 150^\circ\text{C}$

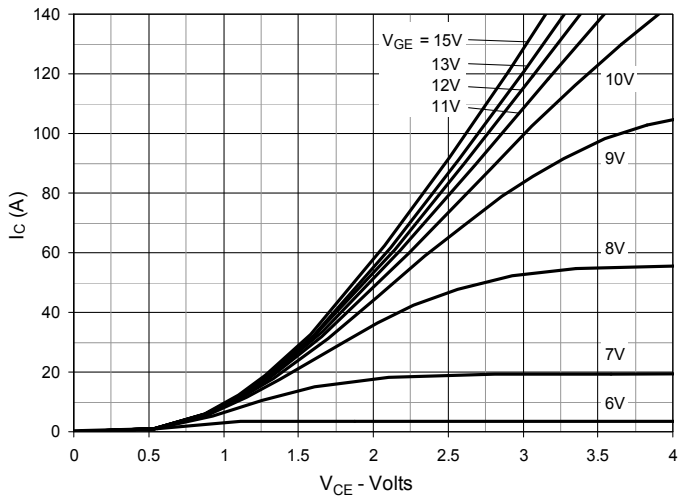

Fig. 4. Dependence of $V_{CE(sat)}$ on Junction Temperature

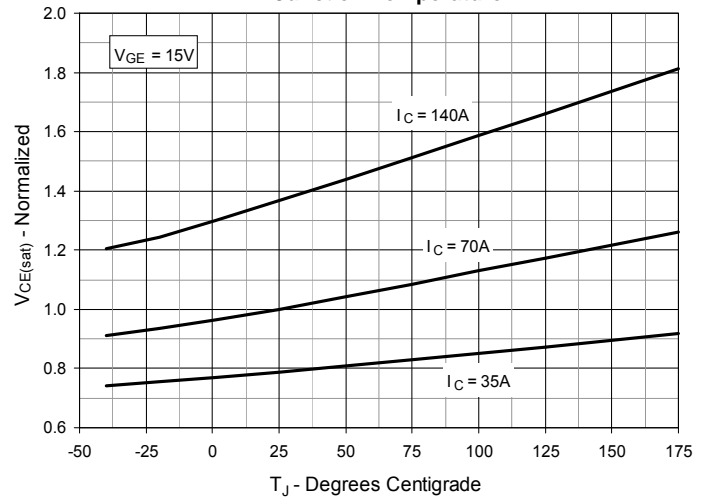

Fig. 5. Collector-to-Emitter Voltage vs. Gate-to-Emitter Voltage

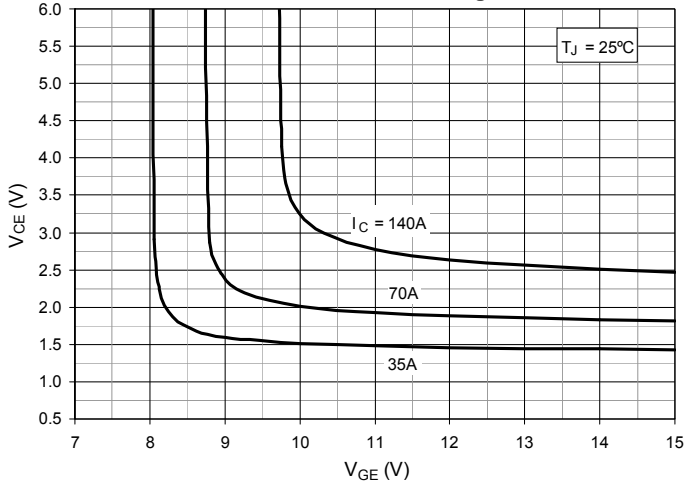

Fig. 6. Input Admittance

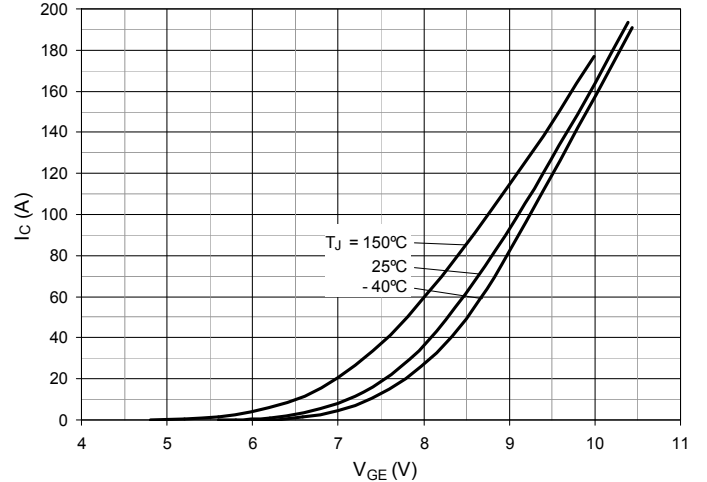

Fig. 7. Transconductance

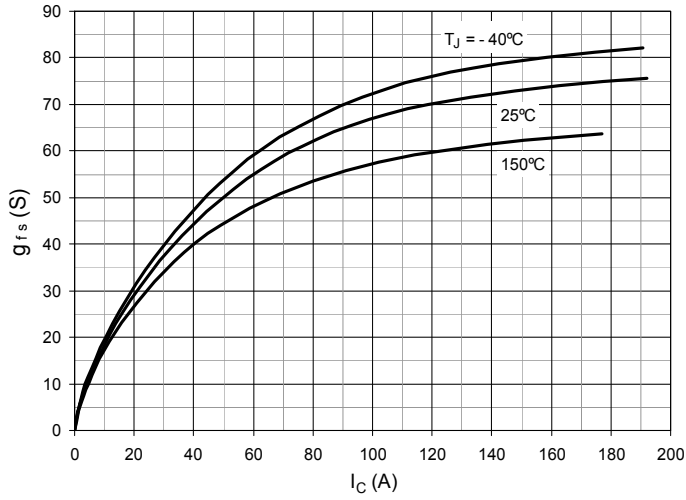

Fig. 8. Gate Charge

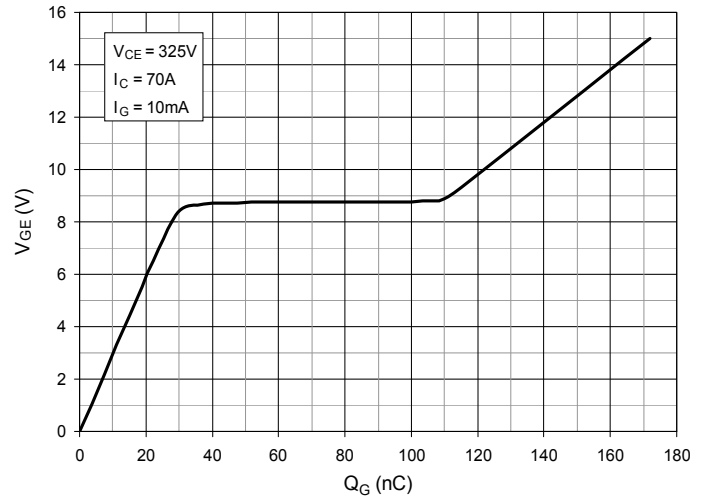

Fig. 9. Capacitance

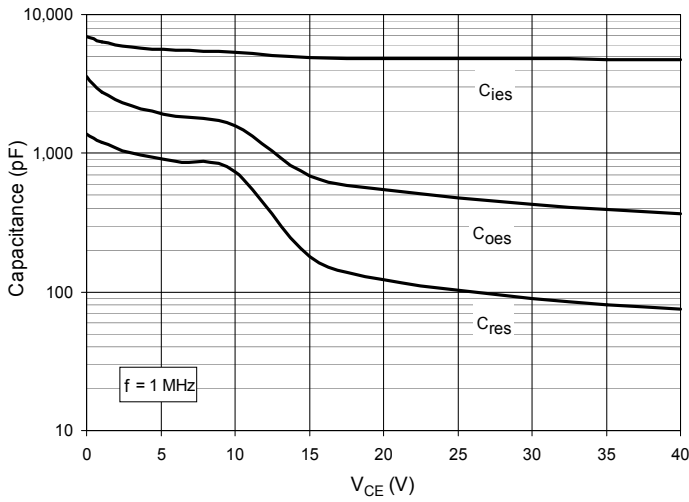

Fig. 10. Reverse-Bias Safe Operating Area

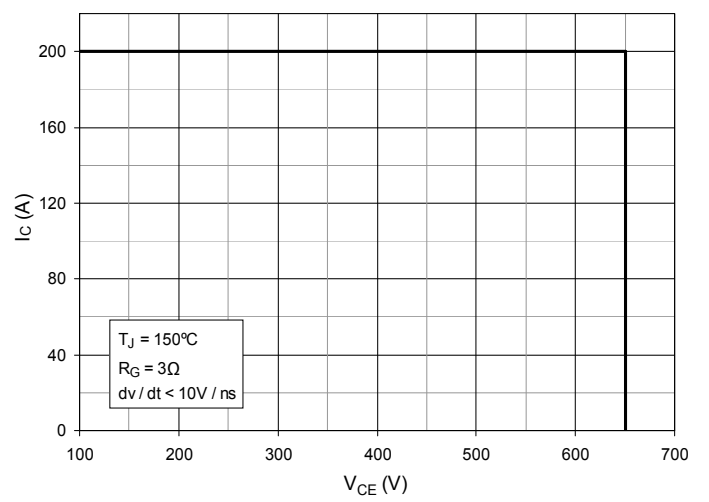

Fig. 11. Forward-Bias Safe Operating Area

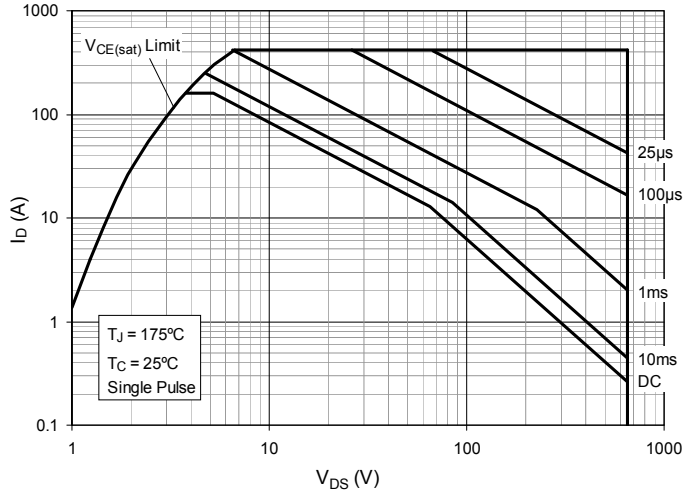

Fig. 12. Maximum Transient Thermal Impedance (IGBT)

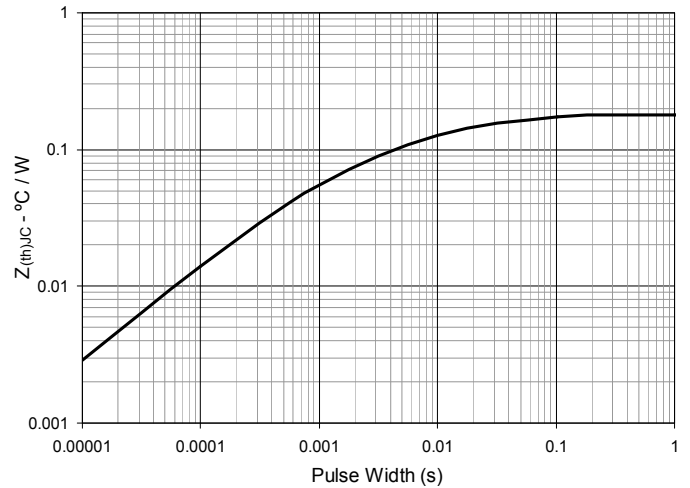

Fig. 13. Inductive Switching Energy Loss vs. Gate Resistance

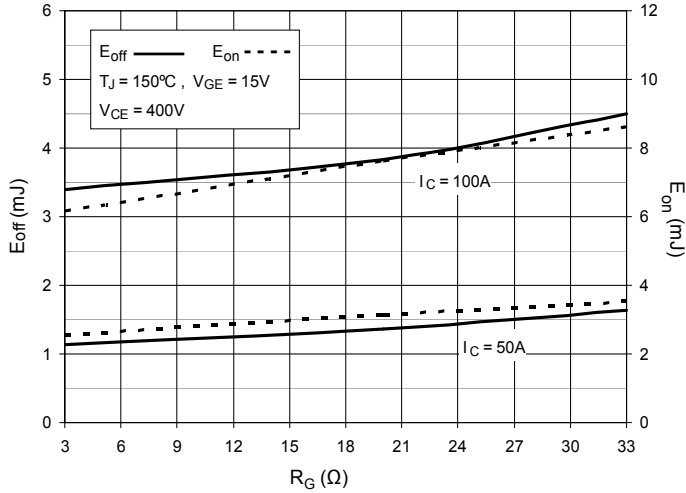

Fig. 14. Inductive Switching Energy Loss vs. Collector Current

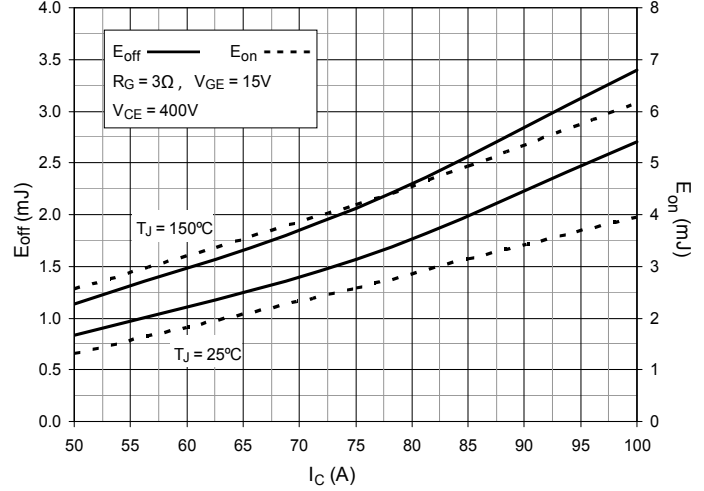

Fig. 15. Inductive Switching Energy Loss vs. Junction Temperature

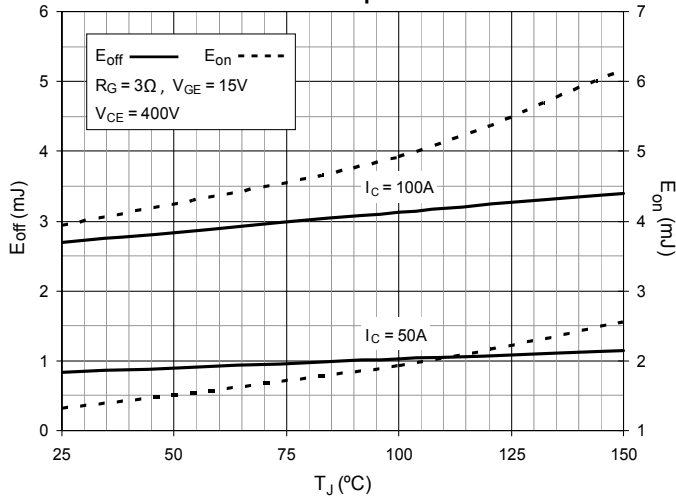

Fig. 16. Inductive Turn-off Switching Times vs. Gate Resistance

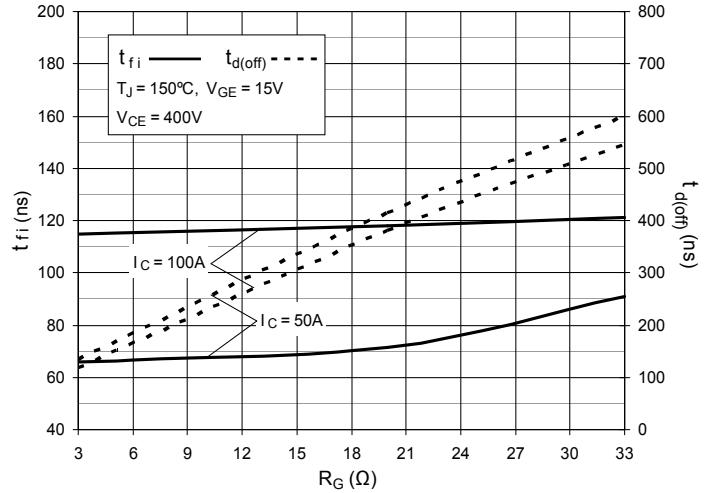

Fig. 17. Inductive Turn-off Switching Times vs. Collector Current

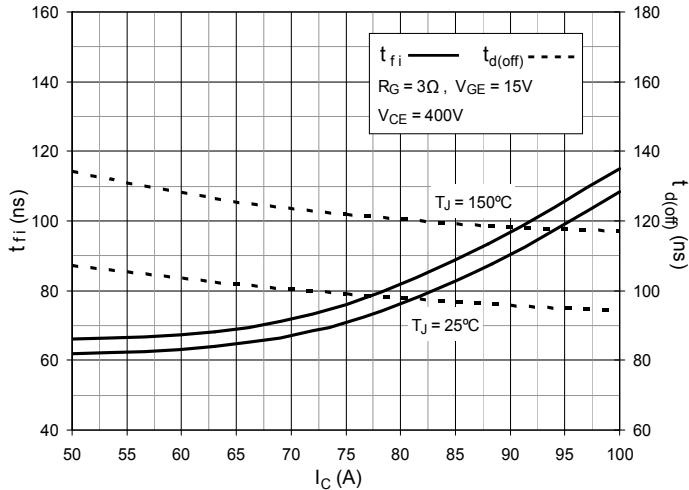

Fig. 18. Inductive Turn-off Switching Times vs. Junction Temperature

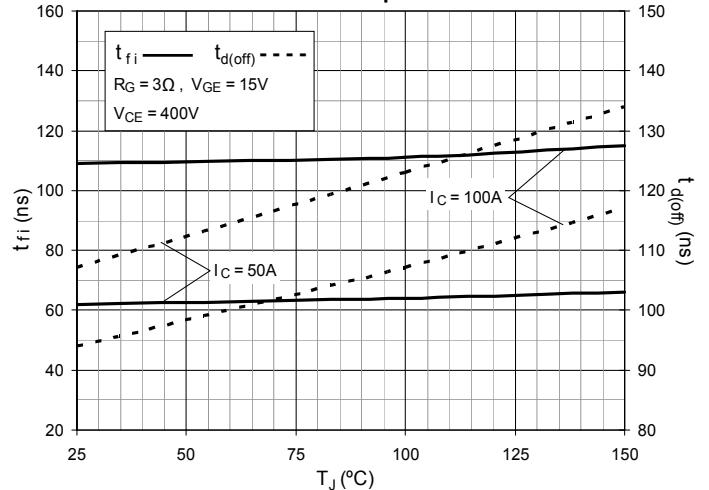

Fig. 19. Inductive Turn-on Switching Times vs. Gate Resistance

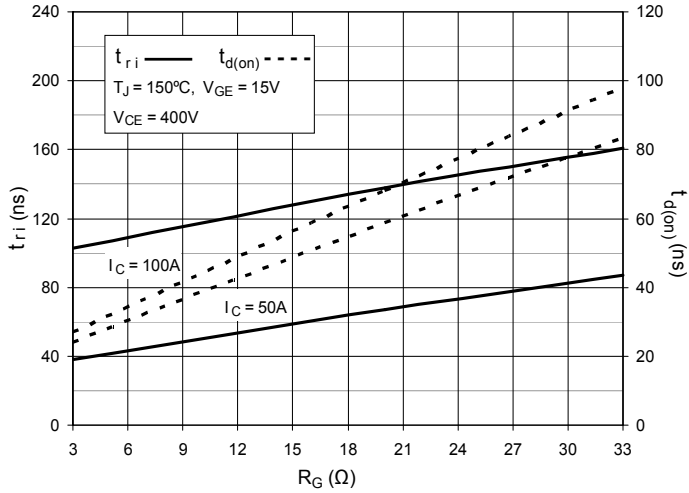

Fig. 20. Inductive Turn-on Switching Times vs. Collector Current

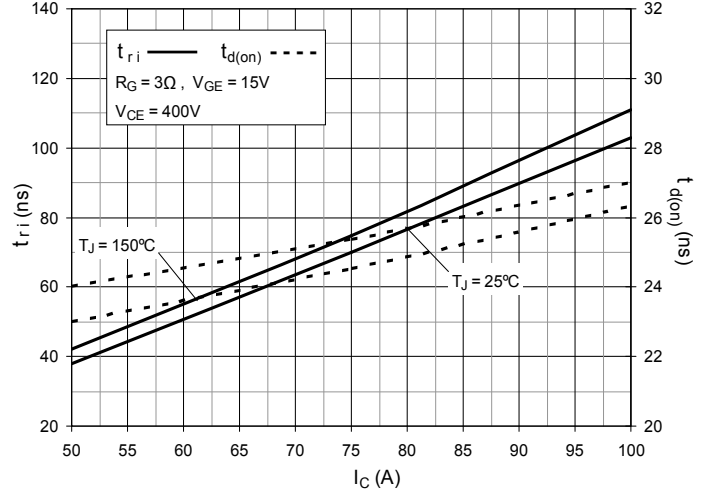

Fig. 21. Inductive Turn-on Switching Times vs. Junction Temperature

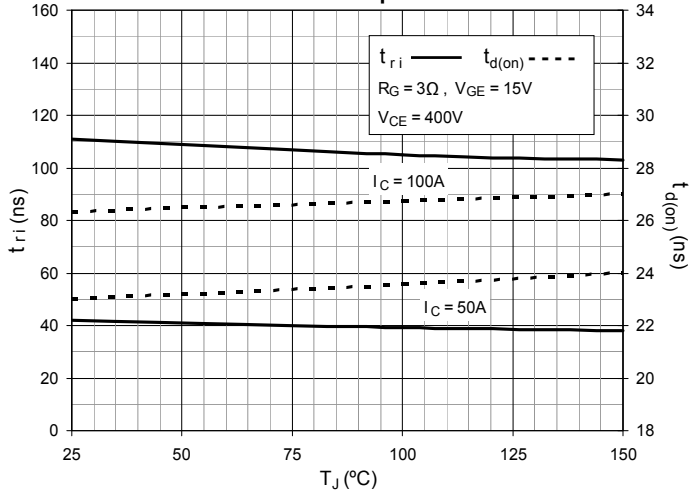

Fig. 22. Maximum Peak Load Current vs. Frequency

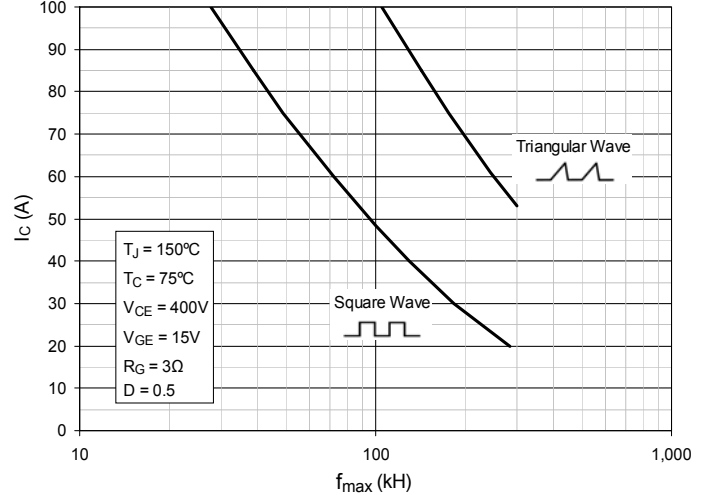

Fig. 23. Diode Forward Characteristics

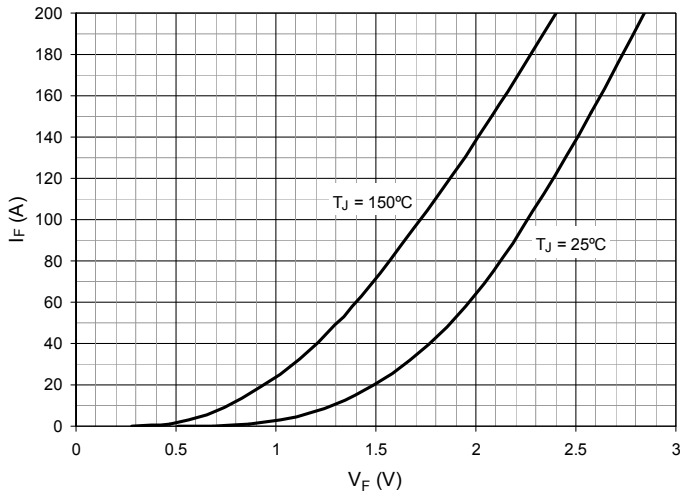

Fig. 24. Reverse Recovery Charge vs. $-di_F/dt$

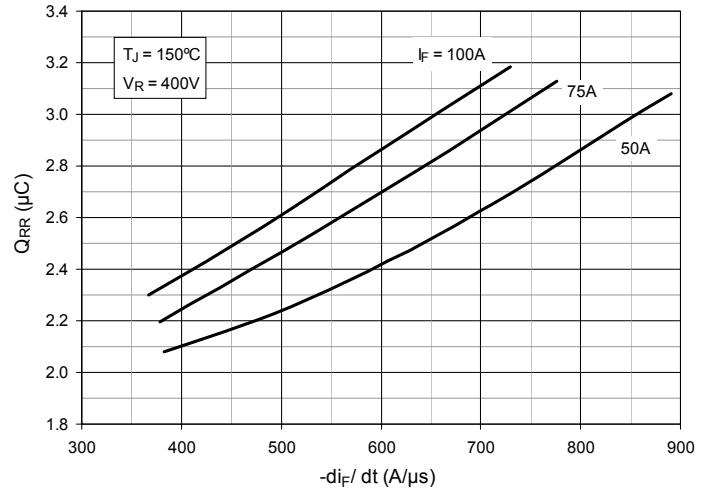

Fig. 25. Reverse Recovery Current vs. $-di_F/dt$

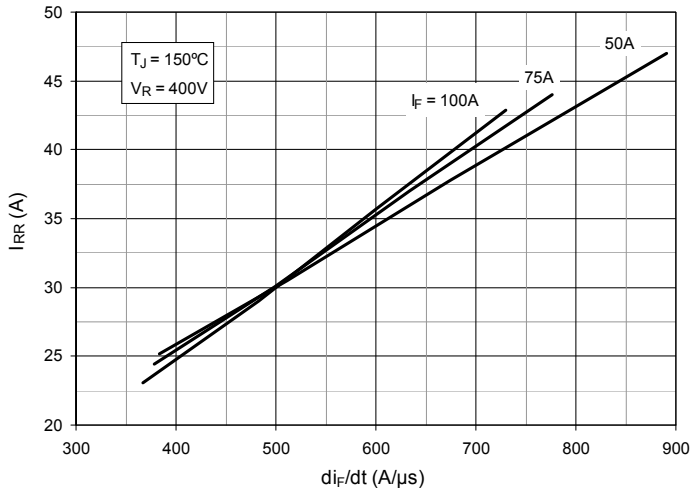

Fig. 26. Reverse Recovery Time vs. $-di_F/dt$

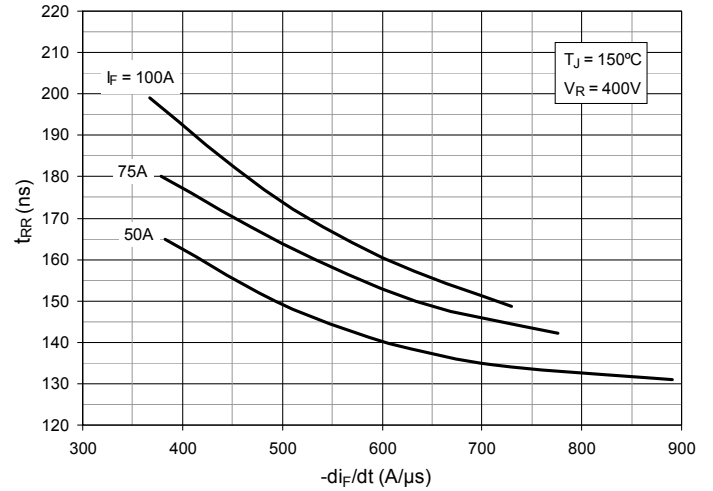

Fig. 27. Dynamic Parameters Q_{RR} , I_{RR} vs. Junction Temperature

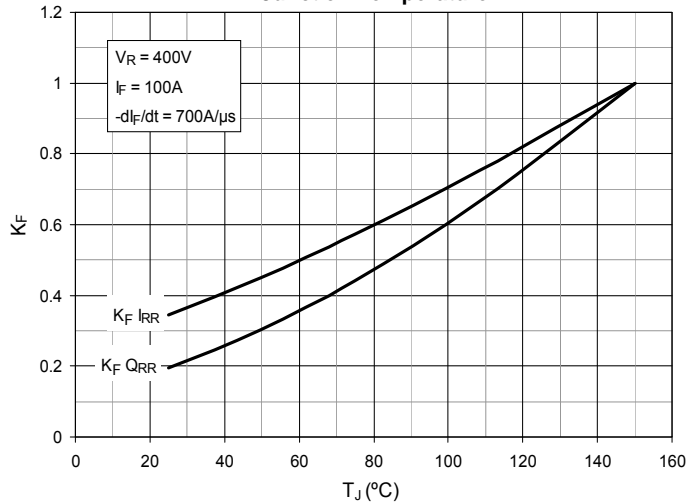
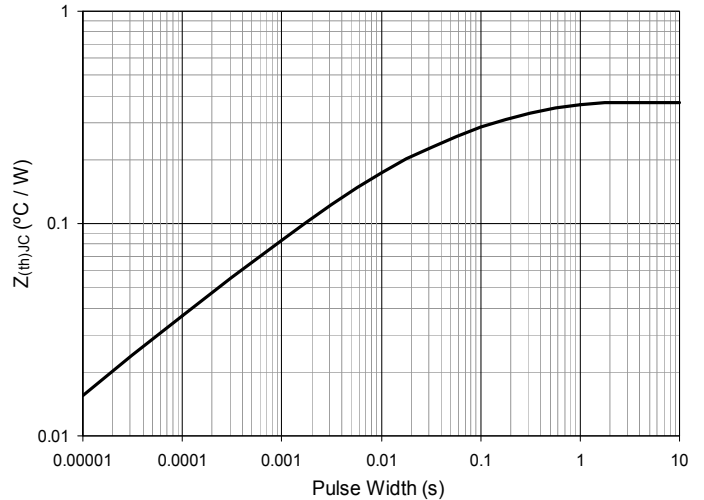

Fig. 28. Maximum Transient Thermal Impedance (Diode)





Disclaimer Notice - Information furnished is believed to be accurate and reliable. However, users should independently evaluate the suitability of and test each product selected for their own applications. Littelfuse products are not designed for, and may not be used in, all applications. Read complete Disclaimer Notice at www.littelfuse.com/disclaimer-electronics.