

zeptoSMDC Series

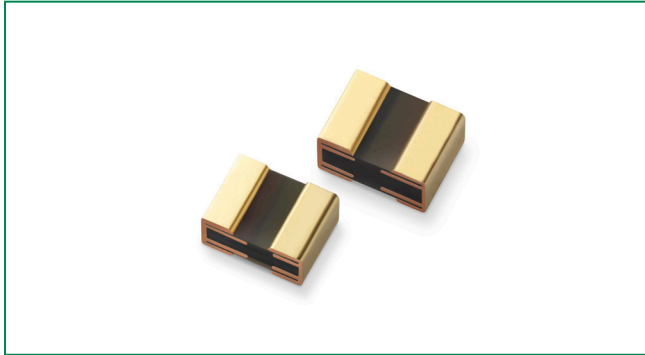

Description

Littelfuse zeptoSMDC Series PPTC is developed for overcurrent and overtemperature protection in mobile applications. It works as a 'fail-safe' to protect battery management ICs and fuel gauges.

Features

- Maximum electrical rating: 13 VDC
- Short circuit current: 82~200mA
- Small footprint 0201 size
- RoHS compliant
- ISO/TS 16949 certified

Applications

- Smartphones and Tablets
- Notebook PC
- e-Readers
- Portable medical equipment
- Mobile point of sale
- Wearables
- Smartwatches
- Wireless speakers
- Portable game players

Benefits

- Resets to normal operation after fault is cleared
- Help protect battery monitor IC from electrical over-stress
- Save space due to small footprint

Electrical Characteristics

Part Number	Initial Resistance Ohms @ 25°C		V_{MAX}^2 (Vdc)	I_{MAX}^3 (mA)	Trip Temperature °C TYP	Hold Current ⁴ (mA) @ 25°C	Time to Trip ⁵		Post Process Resistance ⁶	
	Min ¹	Max					Current (mA)	Time (ms) Max	ohms @ -20°C Min	ohms @ 60°C Max
zeptoSMDC0011F	10	80	13	82	125	11	80	20	68	290
zeptoSMDC0015F	10	60	13	200	125	15	80	20	28	150

Notes:

1. R_{min} = Minimum resistance of device in initial (un-soldered) state
2. V_{max} = Maximum voltage device can withstand without damage at rated current (I_{max})
3. I_{max} = Maximum fault current device can withstand without damage at rated voltage (V_{max})
4. I_{hold} = Hold current: maximum current device will pass without tripping in 25°C still air. Values specified using PCB's with 0.004" x 1.0 ounce copper traces
5. Time to trip values specified using PCB's with 0.004" x 1.0 ounce copper traces
6. With LOCTITE ECCOBOND UF 3915, curing condition: 140°C/20mins, resistance is measured 12 hours post coating curing process

Environmental Specifications

Operating Temperature	-20°C to 60°C
Passive Aging	+85°C, 1000 hours -25% typical resistance change
Humidity Aging	+65°C, 90% R.H., 100 hours -/+15% typical resistance change
Thermal Shock	MIL-STD-202, Method 107G -33% typical resistance change -40°C to +85°C (20 Times)
Vibration	MIL-STD-202, Method 204, Condition A No change
Moisture Sensitivity Level	Level 2a, J-STD-020

Physical Specifications

Terminal Materials	Solder-Plated Copper (Solder Material: NiAu)
Lead Solderability	Meets EIA Specification RS186-9E, ANSI/J-STD-002B, Test S

Soldering Parameters

Profile Feature	Pb-free assembly	
Average Ramp-Up Rate (Liquidus Temp (T_L) to peak)	1~3°C/second max.	
Preheat	Temperature Min. ($T_{s_{min}}$)	130°C
	Temperature Max. ($T_{s_{max}}$)	180°C
	Time Min. to Max. (T_s)	90-110 seconds
$T_{s_{max}}$ to T_L Ramp-up Rate	≤2°C/seconds max.	
Reflow	Temperature (T_L) (Liquidus)	217°C
	Time (t_L)	60~70 seconds
Peak Temperature (T_p)	240°C	
Time within 3°C of actual Peak Temperature (t_p)	35 seconds	
Ramp-Down Rate	2~4°C/seconds	
Time 25°C to Peak Temperature (T_p)	300 seconds max.	

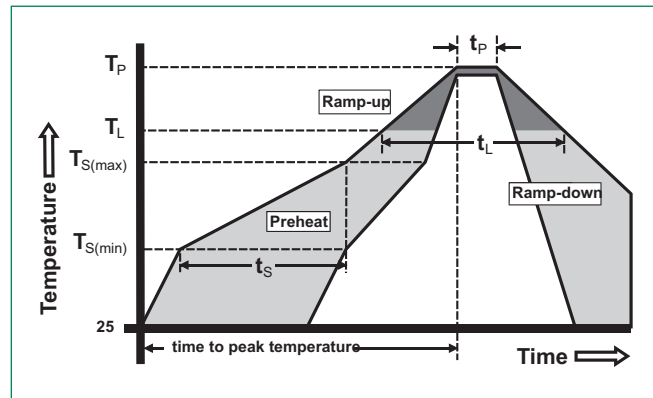

- All temperature refer to topside of the package, measured on the package body surface.
- If reflow temperature exceeds the recommended profile, devices may not meet the performance requirements.
- Recommended reflow methods: IR, vapor phase oven, hot air oven.
- Customer should validate that the solder paste amount and reflow recommendations to meet its application
- Recommended maximum paste thickness is 0.25 mm (0.010 inch).
- Devices can be cleaned using standard industry methods and aqueous solvents.
- Devices can be reworked using the standard industry practices (avoid contact to the device).

Physical Dimension

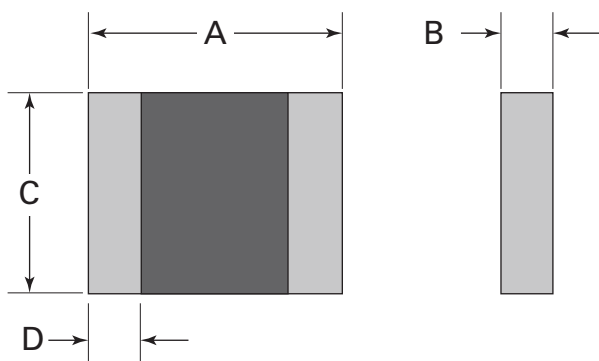

Solder Pad Layout

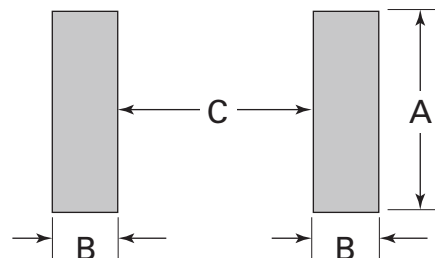

Part Number	A		B		C		D	
	Min	Max	Min	Max	Min	Max	Min	Max
zeptoSMDC0011F	0.55 (0.022)	0.65 (0.026)	—	0.40 (0.016)	0.40 (0.016)	0.50 (0.020)	0.10 (0.004)	0.25 (0.010)
zeptoSMDC0015F	0.55 (0.022)	0.65 (0.026)	—	0.40 (0.016)	0.40 (0.016)	0.50 (0.020)	0.10 (0.004)	0.25 (0.010)

Packaging

Part Number	Ordering	Tape & Reel Quantity	Minimum Order Quantity	Recommended Pad Layout Figures [mm(in)]		
				Dimension A (Nom)	Dimension B (Nom)	Dimension C (Nom)
zeptoSMDC0011F	RF5005-000	15,000	15,000	0.45 (0.0178)	0.325 (0.013)	0.250 (0.010)
zeptoSMDC0015F	RF5006-000	15,000	15,000	0.45 (0.0178)	0.325 (0.013)	0.250 (0.010)

Part Numbering System

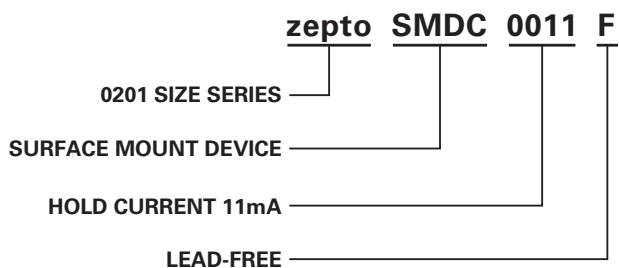

Warning

- Electrical performance of the device can differ according to installation conditions. Users should independently evaluate the suitability of the device under the actual application conditions.
- Operation beyond maximum ratings may result in device damage.
- Exposure to silicon-based oils, solvents, electrolytes, acids, or similar materials can adversely affect device performance.
- The device undergoes thermal expansion during fault conditions. It should be provided with adequate space to allow expansion and should be protected against mechanical stress.
- Consult with Littelfuse if the device will experience thermal process other than reflow onto PCB board, such as molding or hand soldering.

Tape and Reel Specifications

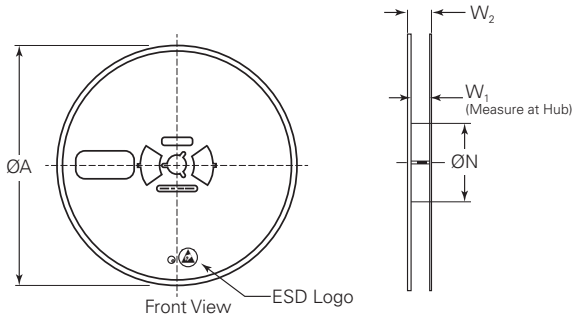
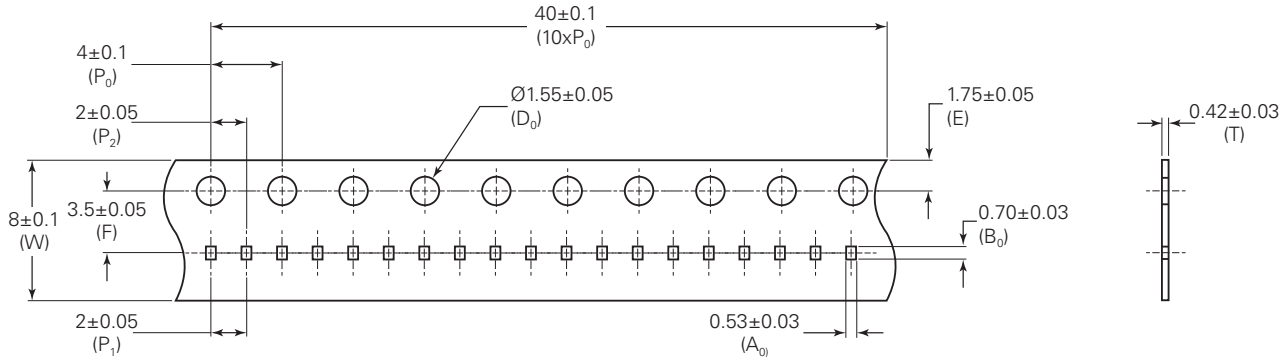

Standard Pack Quantity: 15,000 pcs
Minimum Order Quantity: 15,000 pcs

All dimensions in mm	
W	8 ± 0.1
P₀	4 ± 0.1
P₁	2 ± 0.05
P₂	2 ± 0.05
A₀	0.53 ± 0.03
B₀	0.70 ± 0.03
D₀	1.55 ± 0.05
F	3.5 ± 0.05
E	1.75 ± 0.05
T	0.42 ± 0.03
A	178.0 ± 1.0
N	54.0 ± 0.5
W₁	9.5 ± 0.5
W_{2 max}	15.0

Disclaimer Notice - Information furnished is believed to be accurate and reliable. However, users should independently evaluate the suitability of and test each product selected for their own applications. Littelfuse products are not designed for, and may not be used in, all applications. Read complete Disclaimer Notice at www.littelfuse.com/disclaimer-electronics.