

# AxxxxUx4 Series

## Asymmetrical Multiport SIDACtor® MS-013



### Description

AxxxxUx4 Series are SIDACtor® components designed to protect LCAS (Line Circuit Access Switch) devices from damaging overvoltage transients. The series provides robust peak surge current capability that enables equipment to comply with various global regulatory standards.

### Features and Benefits

- Low voltage overshoot
- Low on-state voltage
- Surge capability does not degrade after multiple surge events within limit
- Fails short circuit when surged in excess of ratings
- Replaces four discrete components
- Two-port protection
- RoHS Compliant, Lead-Free and Halogen Free
- LCAS specific tip and ring thresholds
- Pb-free E3 means 2nd level interconnect is Pb-free and the terminal finish material is tin (Sn) (IPC/JEDEC J-STD-609A.01)

### Additional Information



Resources



Accessories



Samples

### Agency Approvals

Agency	Agency File Number
	E133083

### Applicable Global Standards

- TIA-968-A
- TIA-968-B
- ITU K.20/21 Enhanced Level\*
- ITU K.20/21 Basic Level
- GR 1089 Inter-building\*
- GR 1089 Intra-building
- IEC 61000-4-5 2nd Edition
- YD/T 1082
- YD/T 993
- YD/T 950

\*A-rated parts require series resistance

### Pinout Designation

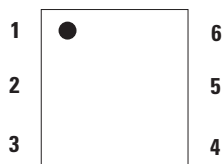

### Schematic Symbol

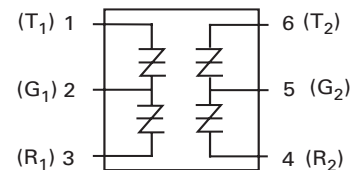

### Electrical Characteristics

Part Number	Part Marking	$V_{DRM} @ I_{DRM} = 5\mu A$	$V_s @ 100V/\mu s$	$V_{DRM} @ I_{DRM} = 5\mu A$	$V_s @ 100V/\mu s$	$V_T @ I_T = 2.2 \text{ Amps}$	$I_s$ mA	$I_T$ A	$I_H$ mA
		V	V	V	V	V			
		Pins 2-3, 5-6		Pins 1-2, 4-5		Pins 1-2, 2-3, 4-5, 5-6			
A1220UA4Lxx	A1220UA4	100	130	180	220	4	800	2.2	120
A1225UA4Lxx	A1250UA4	100	130	230	290	4	800	2.2	120
A1220UC4Lxx	A1220UC4	100	130	180	220	4	800	2.2	120
A1225UC4Lxx	A1250UC4	100	130	230	290	4	800	2.2	120

**Notes:**  
 - Absolute maximum ratings measured at  $T_A = 25^\circ C$  (unless otherwise noted).  
 - Components are bi-directional.  
 - All electrical characteristics shown are defined from Tip to Ground (pin 1 to pin 2 and pin 6 to pin 5) and Ring to Ground (pin 3 to pin 2 and pin 4 to pin 5).  
 - XX = Part Number Suffix: 'TP' (Tube Pack) or 'RP' (Reel Pack).

# AxxxxUx4 Series

## Asymmetrical Multiport SIDACtor® MS-013

### Capacitance Values

Part Number	pF Pin 1-2 / 4-5 Ring-Ground		pF Pin 3-2 / 6-5 Tip-Ground		pF Pin 1-3 (4-6) Tip-Ring	
	MIN	MAX	MIN	MAX	MIN	MAX
A1220UA4Lxx	15	25	30	50	5	20
A1225UA4Lxx	15	25	30	50	5	20
A1220UC4Lxx	35	50	60	90	20	35
A1225UC4Lxx	35	50	60	90	20	35

Note: Off-state capacitance ( $C_{ij}$ ) is measured at 1 MHz with a 2 V bias.

### Surge Ratings

Series	$I_{PP}$										$I_{TSM}$ 50/60 Hz	di/dt
	0.2/310 <sup>1</sup> 0.5/700 <sup>2</sup>	2/10 <sup>1</sup> 2/10 <sup>2</sup>	8/20 <sup>1</sup> 1.2/50 <sup>2</sup>	10/160 <sup>1</sup> 10/160 <sup>2</sup>	10/560 <sup>1</sup> 10/560 <sup>2</sup>	5/320 <sup>1</sup> 9/720 <sup>2</sup>	10/360 <sup>1</sup> 10/360 <sup>2</sup>	10/1000 <sup>1</sup> 10/1000 <sup>2</sup>	5/310 <sup>1</sup> 10/700 <sup>2</sup>			
	A min	A min	A min	A min	A min	A min	A min	A min	A min	A min		
A	20	150	150	90	50	75	75	45	75	20	500	
C	50	500	400	200	150	200	175	100	200	30	500	

**Notes:**

- 1 Current waveform in  $\mu$ s
- 2 Voltage waveform in  $\mu$ s
- Peak pulse current rating ( $I_{pp}$ ) is repetitive and guaranteed for the life of the product.
- $I_{pp}$  ratings applicable over temperature range of -40°C to +85°C
- The component must initially be in thermal equilibrium with -40°C  $\leq$   $T_j$   $\leq$  +150°C

### Thermal Considerations

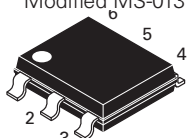
Package	Symbol	Parameter	Value	Unit
Modified MS-013 	$T_J$	Operating Junction Temperature Range	-40 to +125	°C
	$T_S$	Storage Temperature Range	-65 to +150	°C
	$R_{\theta JA}$	Thermal Resistance: Junction to Ambient	60	°C/W

### V-I Characteristics

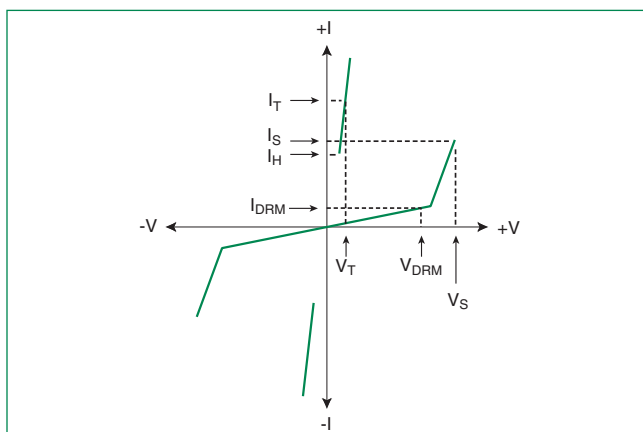

### tr x td Pulse Waveform

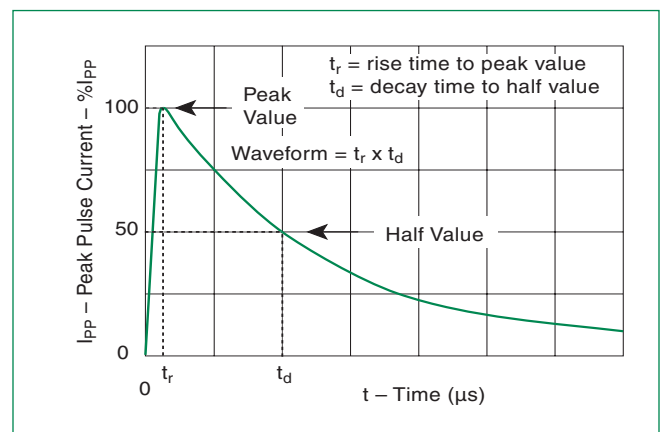

# AxxxxUx4 Series

## Asymmetrical Multiport SIDACtor® MS-013

Normalized VS Change vs. Junction Temperature

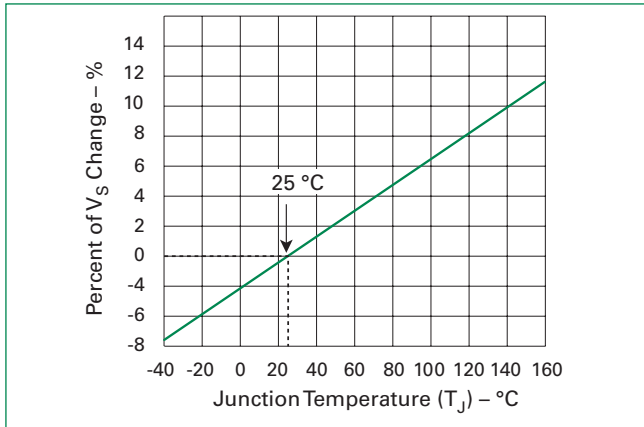

Normalized DC Holding Current vs. Case Temperature

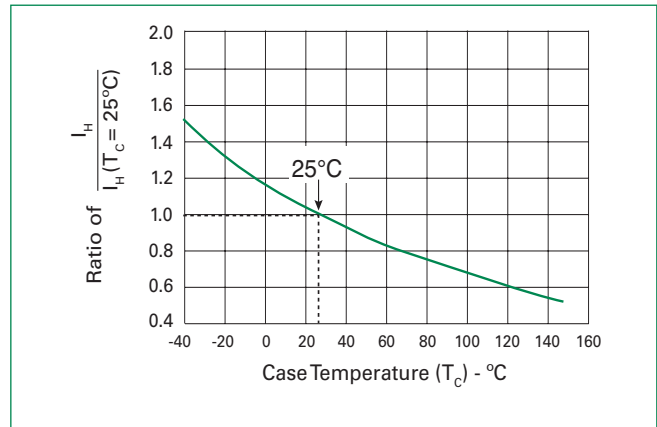

### Soldering Parameters

<b>Reflow Condition</b>	Pb-Free assembly (see Fig. 1)	
<b>Pre Heat</b>	- Temperature Min (T <sub>s(min)</sub> )	+150°C
	- Temperature Max (T <sub>s(max)</sub> )	+200°C
	- Time (Min to Max) (t <sub>s</sub> )	60-180 secs.
<b>Average ramp up rate (Liquidus Temp (T<sub>L</sub>) to peak)</b>	3°C/sec. Max.	
<b>T<sub>s(max)</sub> to T<sub>L</sub> - Ramp-up Rate</b>	3°C/sec. Max.	
<b>Reflow</b>	- Temperature (T <sub>L</sub> ) (Liquidus)	+217°C
	- Temperature (t <sub>L</sub> )	60-150 secs.
<b>Peak Temp (T<sub>p</sub>)</b>	+260(+0/-5)°C	
<b>Time within 5°C of actual Peak Temp (t<sub>p</sub>)</b>	30 secs. Max.	
<b>Ramp-down Rate</b>	6°C/sec. Max.	
<b>Time 25°C to Peak Temp (T<sub>p</sub>)</b>	8 min. Max.	
<b>Do not exceed</b>	+260°C	

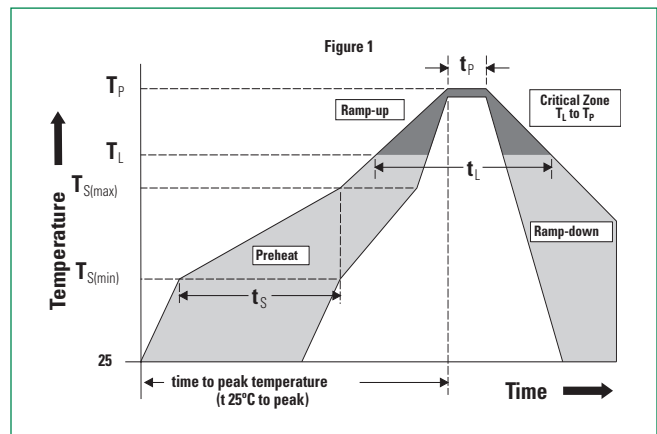

### Physical Specifications

<b>Lead Material</b>	Copper Alloy
<b>Terminal Finish</b>	100% Matte-Tin Plated
<b>Body Material</b>	UL recognized epoxy meeting flammability classification V-0

### Part Numbering

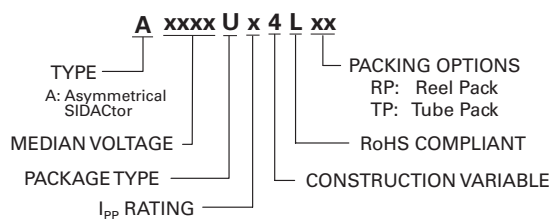

### Environmental Specifications

<b>High Temp Voltage Blocking</b>	80% Rated V <sub>DRM</sub> (V <sub>AC</sub> Peak) +125°C or +150°C, 504 or 1008 hrs. MIL-STD-750 (Method 1040) JEDEC, JESD22-A-101
<b>Temp Cycling</b>	-65°C to +150°C, 15 min. dwell, 10 up to 100 cycles. MIL-STD-750 (Method 1051) EIA/JEDEC, JESD22-A104
<b>Biased Temp &amp; Humidity</b>	52 V <sub>DC</sub> (+85°C) 85%RH, 504 up to 1008 hrs. EIA/JEDEC, JESD22-A-101
<b>High Temp Storage</b>	+150°C 1008 hrs. MIL-STD-750 (Method 1031) JEDEC, JESD22-A-101
<b>Low Temp Storage</b>	-65°C, 1008 hrs.
<b>Thermal Shock</b>	0°C to +100°C, 5 min. dwell, 10 sec. transfer, 10 cycles. MIL-STD-750 (Method 1056) JEDEC, JESD22-A-106
<b>Unbiased Highly Accelerated Stress Test</b>	+130°C, 85%RH, 2atm, 96 hrs. JESD22-A-118
<b>Resistance to Solder Heat</b>	+260°C, 30 secs. MIL-STD-750 (Method 2031)
<b>Moisture Sensitivity Level</b>	85%RH, +85°C, 168 hrs., 3 reflow cycles (+260°C Peak). JEDEC-J-STD-020, Level 1

# AxxxxUx4 Series

## Asymmetrical Multiport SIDACtor® MS-013

### Part Marking

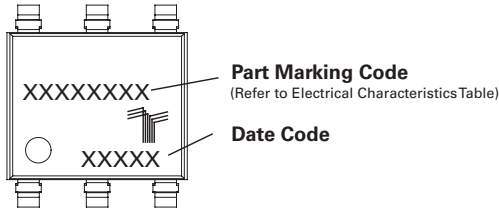

### Packing Options

Package Type	Description	Quantity	Added Suffix	Industry Standard
U	Modified MS-013 6-pin Tape and Reel Pack	1500	RP	EIA-481-D
	Modified MS-013 6-pin Tube Pack	500 (50 per tube)	TP	N/A

### Dimensions – MS-013

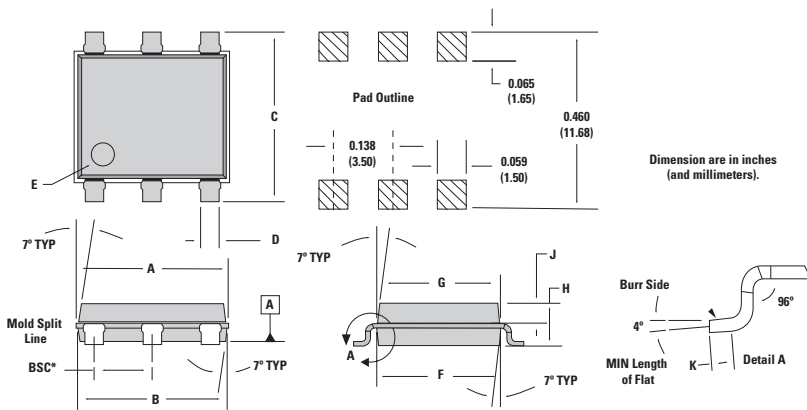

Dimensions	Inches		Millimeters	
	Min	Max	Min	Max
A	0.360	0.364	9.14	9.25
B	0.352	0.356	8.94	9.04
C	0.400	0.412	10.16	10.46
D	0.043	0.045	1.09	1.13
E	0.047	0.055	1.19	1.40
F	0.293	0.297	7.44	7.54
G	0.289	0.293	7.34	7.44
H	0.089	0.093	2.26	2.36
J	0.041	0.049	1.04	1.24
K	0.020		0.51	
BSC*	0.133	0.143	3.38	3.63

\* BSC = Basic Spacing between Centers

### Tape and Reel Specification – MS-013

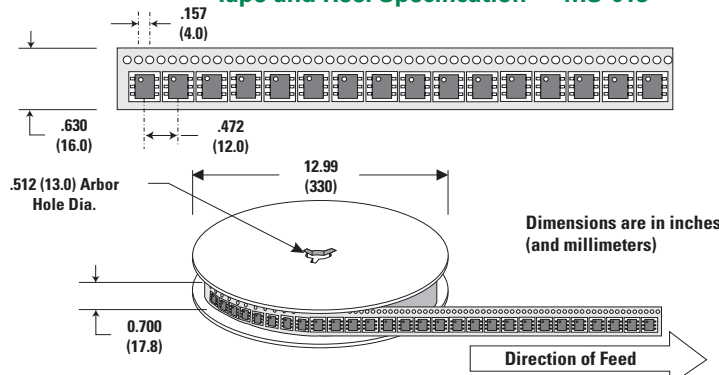

### Tube Pack Specification – MS-013

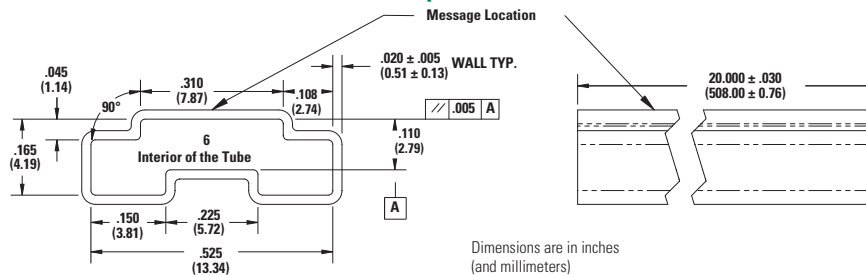

**Disclaimer Notice** - Littelfuse products are not designed for, and shall not be used for, any purpose (including, without limitation, automotive, military, aerospace, medical, life-saving, life-sustaining or nuclear facility applications, devices intended for surgical implant into the body, or any other application in which the failure or lack of desired operation of the product may result in personal injury, death, or property damage) other than those expressly set forth in applicable Littelfuse product documentation. Warranties granted by Littelfuse shall be deemed void for products used for any purpose not expressly set forth in applicable Littelfuse documentation. Littelfuse shall not be liable for any claims or damages arising out of products used in applications not expressly intended by Littelfuse as set forth in applicable Littelfuse documentation. The sale and use of Littelfuse products is subject to Littelfuse Terms and Conditions of Sale, unless otherwise agreed by Littelfuse. "Littelfuse" includes Littelfuse, Inc., and all of its affiliate entities. <http://www.littelfuse.com/disclaimer-electronics>