

AQ1005 Series 30pF 30kV Bidirectional Discrete TVS  **AUTOMOTIVE GRADE**  **HF**  **RoHS**  **Pb**  **GREEN**

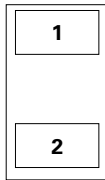

Pinout



Functional Block Diagram

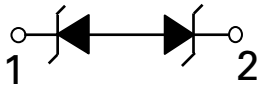

Description

The AQ1005 TVS includes back-to-back breakdown diodes fabricated in a proprietary silicon avalanche technology to provide protection for electronic equipment that may experience destructive electrostatic discharges (ESD). These robust diodes can safely absorb repetitive ESD strikes above the maximum level specified in IEC 61000-4-2 international standard (Level 4, ±8 kV contact discharge and ±15 kV air discharge) without performance degradation. The back-to-back configuration provides symmetrical ESD protection for data lines.

Features

- ESD, IEC 61000-4-2, ±30kV contact, ±30kV air
- ESD, ISO 10605, 330pF 330Ω, ±30kV contact, ±30kV air
- EFT, IEC 61000-4-4, 40A (5/50ns)
- Lightning, 8A (8/20) as defined in IEC 61000-4-5 2nd edition)
- Low capacitance of 30pF (@ V_R=0V)
- Low leakage current of 0.1µA at 5V
- SOD882 footprint compatible to 0402 footprint
- AEC-Q101 qualified
- Halogen free, Lead free and RoHS compliant
- PPAP capable

Applications

- Mobile Phones
- Smart Phones
- Camcorders
- Portable Medical
- Digital Cameras
- MP3/PMP
- Portable Navigation Components
- Tablets
- Point of Sale Terminals
- Automotive Applications

Application Example

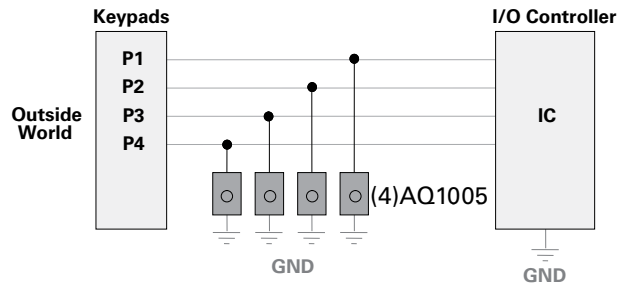

Life Support Note:

Not Intended for Use in Life Support or Life Saving Applications

The products shown herein are not designed for use in life sustaining or life saving applications unless otherwise expressly indicated.

Absolute Maximum Ratings

Symbol	Parameter	Value	Units
I_{PP}	Peak Current ($t_p=8/20\mu s$)	8.0	A
T_{OP}	Operating Temperature	-40 to 150	°C
T_{STOR}	Storage Temperature	-55 to 150	°C

Notes:

1. CAUTION: Stresses above those listed in "Absolute Maximum Ratings" may cause permanent damage to the component. This is a stress only rating and operation of the component at these or any other conditions above those indicated in the operational sections of this specification is not implied.

Electrical Characteristics ($T_{OP}=25^\circ C$)

Parameter	Symbol	Test Conditions	Min	Typ	Max	Units
Reverse Standoff Voltage	V_{RWM}	$I_R=1\mu A$			6.0	V
Breakdown Voltage	V_{BR}	$I_R=1mA$		8.5	9.5	V
Reverse Leakage Current	I_{LEAK}	$V_R=5V$		0.1	0.5	μA
Clamp Voltage ¹	V_C	$I_{PP}=1A, t_p=8/20\mu s, I/O$ to I/O		9.3		V
		$I_{PP}=2A, t_p=8/20\mu s, I/O$ to I/O		10.0		V
Dynamic Resistance ²	R_{DYN}	TLP, $t_p=100ns, I/O$ to I/O		0.25		Ω
ESD Withstand Voltage ¹	V_{ESD}	IEC 61000-4-2 (Contact Discharge)	± 30			kV
		IEC 61000-4-2 (Air Discharge)	± 30			kV
Diode Capacitance ¹	$C_{I/O-I/O}$	Reverse Bias=0V f=1MHz		30		pF
		Reverse Bias=2.5V f=1MHz		23		pF

Note:

1.Parameter is guaranteed by design and/or component characterization.

2.Transmission Line Pulse (TLP) with 100ns width, 2ns rise time, and average window $t_1=70ns$ to $t_2=90ns$

Capacitance vs. Reverse Bias

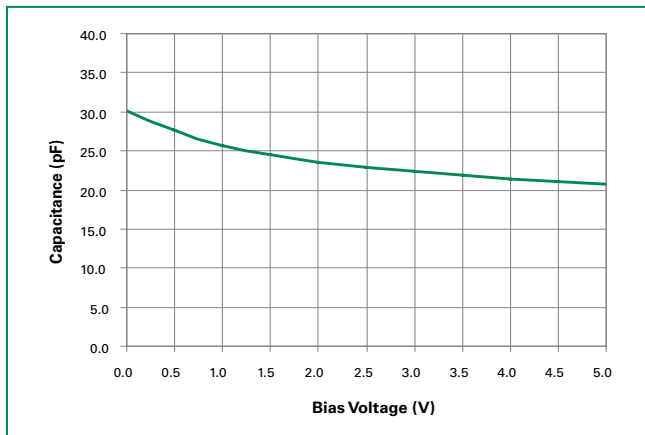

8/20 μs Pulse Waveform

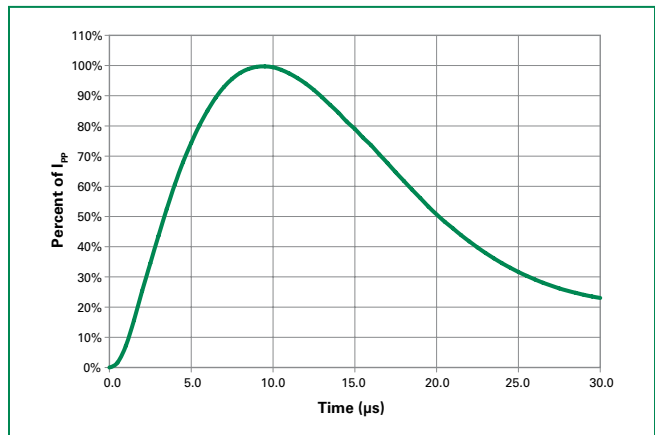

ISO10605 (C:330pF, R:330Ω) contact discharge plot at +8KV

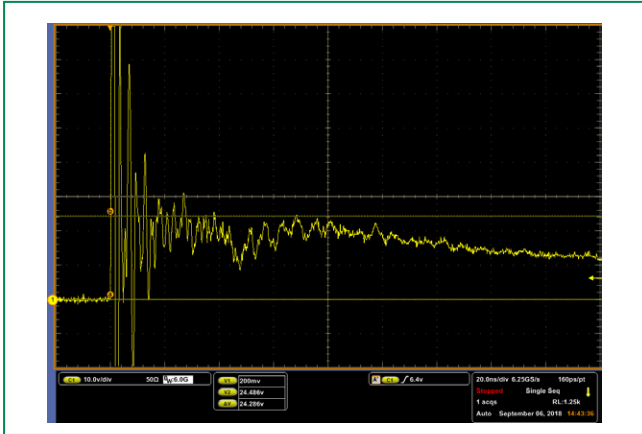

ISO10605 (C:330pF, R:330Ω) contact discharge plot at -8KV

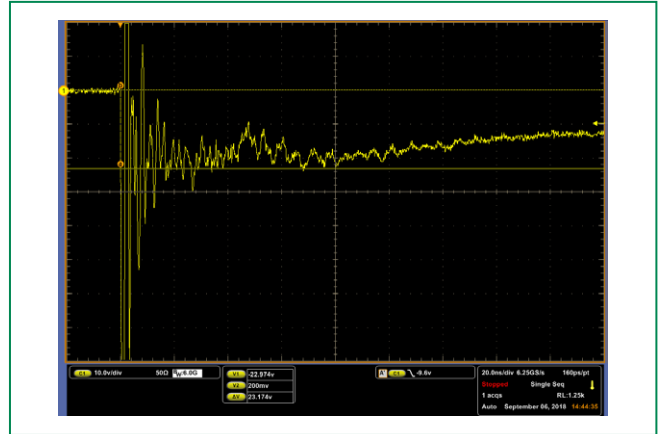

Clamping Voltage vs. I_{pp}

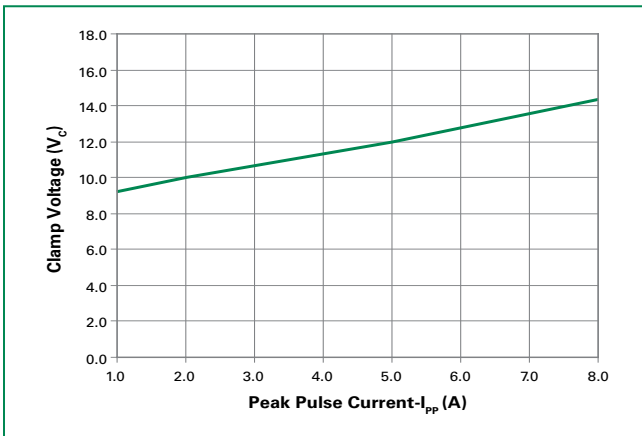

Insertion Loss (S21) I/O to GND

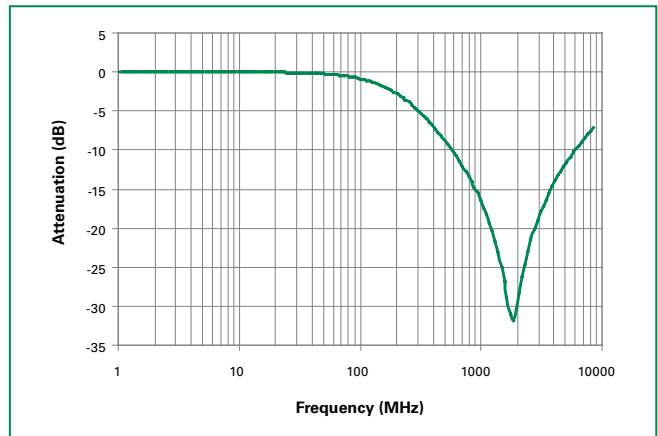

Transmission Line Pulsing (TLP) Plot

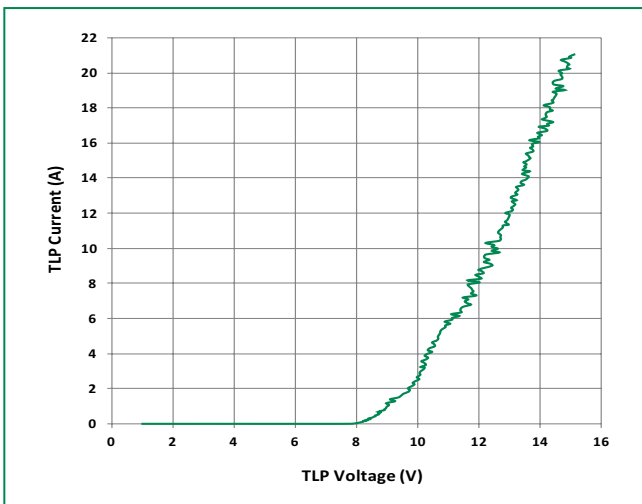

Soldering Parameters

Reflow Condition		Pb – Free assembly
Pre Heat	- Temperature Min ($T_{s(min)}$)	150°C
	- Temperature Max ($T_{s(max)}$)	200°C
	- Time (min to max) (t_s)	60 – 180 secs
Average ramp up rate (Liquidus) Temp (T_L) to peak		3°C/second max
$T_{s(max)}$ to T_L - Ramp-up Rate		3°C/second max
Reflow	- Temperature (T_L) (Liquidus)	217°C
	- Temperature (t_L)	60 – 150 seconds
Peak Temperature (T_p)		260 ^{+0/-5} °C
Time within 5°C of actual peak Temperature (t_p)		20 – 40 seconds
Ramp-down Rate		6°C/second max
Time 25°C to peak Temperature (T_p)		8 minutes Max.
Do not exceed		260°C

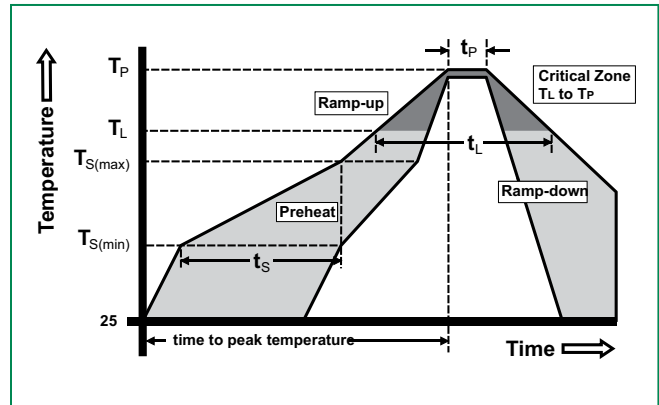

Part Numbering System

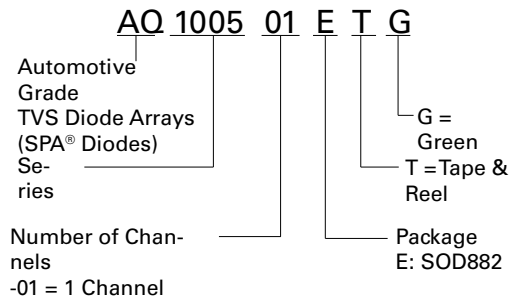

Product Characteristics

Lead Plating	Pre-Plated Frame
Lead Material	Copper Alloy
Substrate material	Silicon
Body Material	Molded Compound
Flammability	UL Recognized compound meeting flammability rating V-0.

Part Marking System

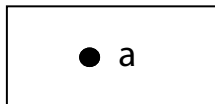

Ordering Information

Part Number	Package	Min. Order Qty.
AQ1005-01ETG	SOD882	10000

Package Dimensions – SOD882

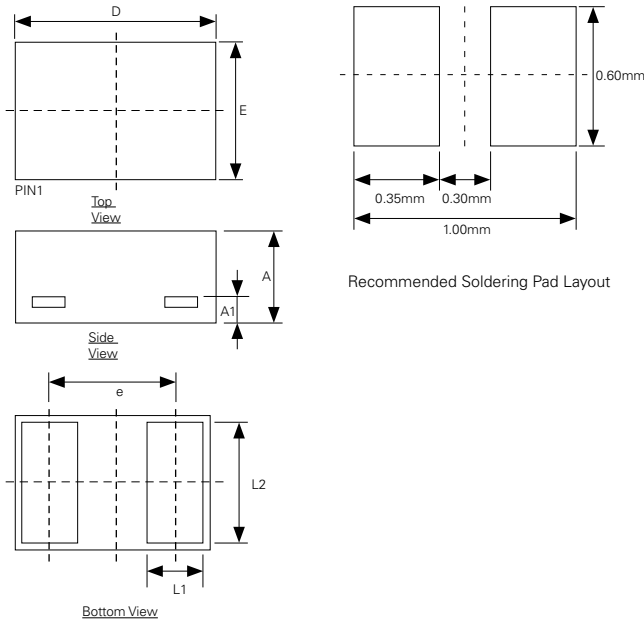

Symbol	Dimensions (mm)			Dimensions (In)		
	Min.	Nor.	Max.	Min.	Nor.	Max.
A	0.36	0.39	0.42	0.014	0.015	0.016
A1	0.127 REF			0.005 REF		
L1	0.20	0.25	0.30	0.008	0.01	0.012
L2	0.45	0.50	0.55	0.018	0.020	0.023
D	0.93	1.00	1.07	0.037	0.039	0.067
E	0.53	0.60	0.67	0.021	0.024	0.026
e	0.65 BSC			0.026 BSC		

Embossed Carrier Tape & Reel Specification – SOD882

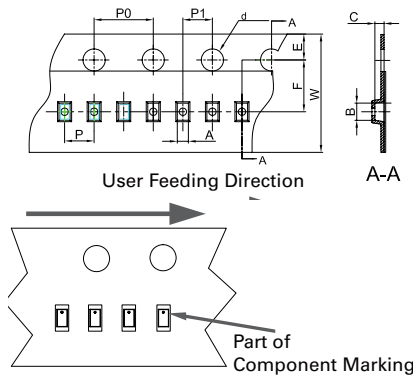

Symbol	Millimetres		Inches	
	Min	Max	Min	Max
A	0.65	0.70	0.026	0.028
B	1.10	1.20	0.043	0.047
C	0.50	0.60	0.020	0.024
dØ	1.40	1.60	0.055	0.063
E	1.65	1.85	0.065	0.073
F	3.40	3.60	0.134	0.142
P0	3.90	4.10	0.154	0.161
P	1.90	2.10	0.075	0.083
P1	1.90	2.10	0.075	0.083
W	7.90	8.10	0.311	0.319

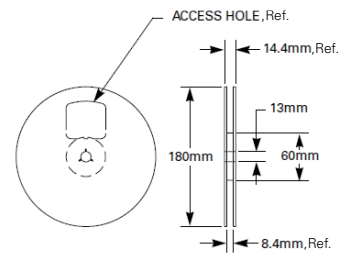

8mm Tape and Reel

Disclaimer Notice - Information furnished is believed to be accurate and reliable. However, users should independently evaluate the suitability of and test each product selected for their own applications. Littelfuse products are not designed for, and may not be used in, all applications. Read complete Disclaimer Notice at <http://www.littelfuse.com/disclaimer-electronics>.