

## SD Series 450W Discrete Unidirectional TVS Diode



### Description

The Unidirectional SD series is designed for use in electronic equipment for low speed and DC applications. It will protect any sensitive equipment from damage due to electrostatic discharge (ESD) and other transient events.

The SD series can safely absorb repetitive ESD strikes at  $\pm 30\text{kV}$  (contact discharge, IEC 61000-4-2) without performance degradation and safely dissipate 30A (SD05) of 8/20 $\mu\text{s}$  induced surge current (IEC61000-4-5 2<sup>nd</sup> edition) with very low clamping voltages.

### Pinout and Functional Block Diagram

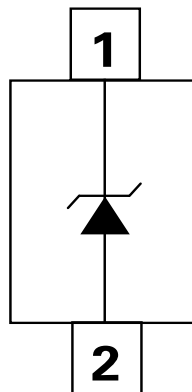

### Features

- ESD, IEC 61000-4-2,  $\pm 30\text{kV}$  contact,  $\pm 30\text{kV}$  air
- EFT, IEC 61000-4-4, 40A (5/50ns)
- Lightning, 30A (8/20 $\mu\text{s}$  as defined in IEC 61000-4-5 2<sup>nd</sup> edition) SD05
- Low clamping voltage
- Low leakage current
- Small SOD323 package fits 0805 footprints
- AEC-Q101 qualified
- RoHS Compliant and Lead Free
- Moisture Sensitivity Level

### Applications

- Switches / Buttons
- Test Equipment / Instrumentation
- Point-of-Sale Terminals
- Medical Equipment
- Notebooks / Desktops / Servers
- Computer Peripherals
- Automotive Electronics

### Additional Information



**Datasheet**



**Resources**



**Samples**

Life Support Note:

**Not Intended for Use in Life Support or Life Saving Applications**

The products shown herein are not designed for use in life sustaining or life saving applications unless otherwise expressly indicated.

### Absolute Maximum Ratings

Symbol	Parameter	Value	Units
$P_{pk}$	Peak Pulse Power ( $t_p=8/20\mu s$ )	450	W
$T_{OP}$	Operating Temperature	-40 to 125	°C
$T_{STOR}$	Storage Temperature	-55 to 150	°C

Note:

CAUTION: Stresses above those listed in "Absolute Maximum Ratings" may cause permanent damage to the device. This is a stress only rating and operation of the device at these or any other conditions above those indicated in the operational sections of this specification is not implied.

### SD05 Electrical Characteristics ( $T_{OP}=25^\circ C$ )

Parameter	Symbol	Test Conditions	Min	Typ	Max	Units
Reverse Standoff Voltage	$V_{BR}$	$I_R=1\mu A$			5.0	V
Breakdown Voltage	$V_{BR}$	$I_R=1 mA$	6.0			V
Reverse Leakage Current	$I_{LEAK}$	$V_R=5V$			1.0	$\mu A$
Clamp Voltage <sup>1</sup>	$V_C$	$I_{pp}=1A, t_p=8/20\mu s, Fwd$			9.8	V
		$I_{pp}=10A, t_p=8/20\mu s, Fwd$			13.0	V
Dynamic Resistance <sup>2</sup>	$R_{DYN}$	TLP, $t_p=100ns$ , I/O to Ground		0.22		$\Omega$
Peak Pulse Current	$I_{pp}$	$t_p=8/20\mu s$			30.0	A
ESD Withstand Voltage <sup>1</sup>	$V_{ESD}$	IEC 61000-4-2 (Contact Discharge)	$\pm 30$			kV
		IEC 61000-4-2 (Air Discharge)	$\pm 30$			kV
Diode Capacitance <sup>1</sup>	$C_{I/O-GND}$	Reverse Bias=0V, f=1MHz			350	pF

### SD12 Electrical Characteristics ( $T_{OP}=25^\circ C$ )

Parameter	Symbol	Test Conditions	Min	Typ	Max	Units
Reverse Standoff Voltage	$V_{RWM}$	$I_R=1\mu A$			12.0	V
Breakdown Voltage	$V_{BR}$	$I_R=1 mA$	13.3			V
Reverse Leakage Current	$I_{LEAK}$	$V_R=12V$			1.0	$\mu A$
Clamp Voltage <sup>1</sup>	$V_C$	$I_{pp}=1A, t_p=8/20\mu s, Fwd$			18.5	V
		$I_{pp}=10A, t_p=8/20\mu s, Fwd$			22.5	V
Dynamic Resistance <sup>2</sup>	$R_{DYN}$	TLP, $t_p=100ns$ , I/O to Ground		0.29		$\Omega$
Peak Pulse Current	$I_{pp}$	$t_p=8/20\mu s$			17.0	A
ESD Withstand Voltage <sup>1</sup>	$V_{ESD}$	IEC 61000-4-2 (Contact Discharge)	$\pm 30$			kV
		IEC 61000-4-2 (Air Discharge)	$\pm 30$			kV
Diode Capacitance <sup>1</sup>	$C_{I/O-GND}$	Reverse Bias=0V, f=1MHz			150	pF

**SD15 Electrical Characteristics (T<sub>Op</sub>=25°C)**

Parameter	Symbol	Test Conditions	Min	Typ	Max	Units
Reverse Standoff Voltage	V <sub>RWM</sub>	I <sub>R</sub> =1μA			15.0	V
Breakdown Voltage	V <sub>BR</sub>	I <sub>R</sub> =1mA	16.7			V
Reverse Leakage Current	I <sub>LEAK</sub>	V <sub>R</sub> =15V			1.0	μA
Clamp Voltage <sup>1</sup>	V <sub>C</sub>	I <sub>PP</sub> =1A, t <sub>p</sub> =8/20μs, Fwd			24.0	V
		I <sub>PP</sub> =10A, t <sub>p</sub> =8/20μs, Fwd			30.0	V
Dynamic Resistance <sup>2</sup>	R <sub>DYN</sub>	TLP, t <sub>p</sub> =100ns, I/O to Ground		0.34		Ω
Peak Pulse Current	I <sub>PP</sub>	t <sub>p</sub> =8/20μs			12.0	A
ESD Withstand Voltage <sup>1</sup>	V <sub>ESD</sub>	IEC 61000-4-2 (Contact Discharge)	±30			kV
		IEC 61000-4-2 (Air Discharge)	±30			kV
Diode Capacitance <sup>1</sup>	C <sub>I/O-GND</sub>	Reverse Bias=0V, f=1MHz			100	pF

**SD24 Electrical Characteristics (T<sub>Op</sub>=25°C)**

Parameter	Symbol	Test Conditions	Min	Typ	Max	Units
Reverse Standoff Voltage	V <sub>RWM</sub>	I <sub>R</sub> =1μA			24.0	V
Breakdown Voltage	V <sub>BR</sub>	I <sub>R</sub> =1mA	26.7			V
Reverse Leakage Current	I <sub>LEAK</sub>	V <sub>R</sub> =24V			1.0	μA
Clamp Voltage <sup>1</sup>	V <sub>C</sub>	I <sub>PP</sub> =1A, t <sub>p</sub> =8/20μs, Fwd			36.0	V
		I <sub>PP</sub> =5A, t <sub>p</sub> =8/20μs, Fwd			42.0	V
Dynamic Resistance <sup>2</sup>	R <sub>DYN</sub>	TLP, t <sub>p</sub> =100ns, I/O to Ground		0.49		Ω
Peak Pulse Current	I <sub>PP</sub>	t <sub>p</sub> =8/20μs			7.0	A
ESD Withstand Voltage <sup>1</sup>	V <sub>ESD</sub>	IEC 61000-4-2 (Contact Discharge)	±30			kV
		IEC 61000-4-2 (Air Discharge)	±30			kV
Diode Capacitance <sup>1</sup>	C <sub>I/O-GND</sub>	Reverse Bias=0V, f=1MHz			65	pF

**SD36 Electrical Characteristics (T<sub>Op</sub>=25°C)**

Parameter	Symbol	Test Conditions	Min	Typ	Max	Units
Reverse Standoff Voltage	V <sub>RWM</sub>	I <sub>R</sub> =1μA			36.0	V
Breakdown Voltage	V <sub>BR</sub>	I <sub>R</sub> =1mA	40.0			V
Reverse Leakage Current	I <sub>LEAK</sub>	V <sub>R</sub> =36V			1.0	μA
Clamp Voltage <sup>1</sup>	V <sub>C</sub>	I <sub>PP</sub> =1A, t <sub>p</sub> =8/20μs, Fwd			52.0	V
		I <sub>PP</sub> =4A, t <sub>p</sub> =8/20μs, Fwd			62.0	V
Dynamic Resistance <sup>2</sup>	R <sub>DYN</sub>	TLP, t <sub>p</sub> =100ns, I/O to Ground		0.61		Ω
Peak Pulse Current	I <sub>PP</sub>	t <sub>p</sub> =8/20μs			5.0	A
ESD Withstand Voltage <sup>1</sup>	V <sub>ESD</sub>	IEC 61000-4-2 (Contact Discharge)	±30			kV
		IEC 61000-4-2 (Air Discharge)	±30			kV
Diode Capacitance <sup>1</sup>	C <sub>I/O-GND</sub>	Reverse Bias=0V, f=1MHz			50	pF

Note:

- Parameter is guaranteed by design and/or component characterization.
- Transmission Line Pulse (TLP) with 100ns width and 200ps rise time.

**Non-Repetitive Peak Pulse Power vs. Pulse Time**

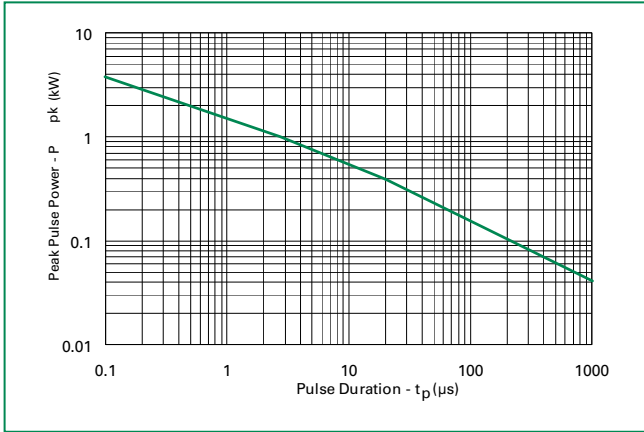

**Capacitance vs. Bias**

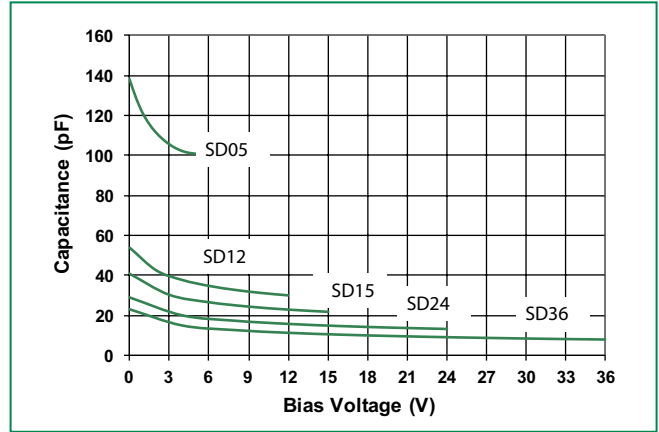

**Power Derating Curve**

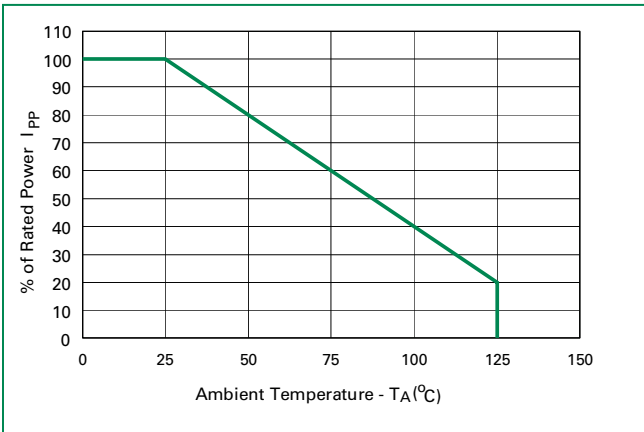

**8/20 μs Pulse Waveform**

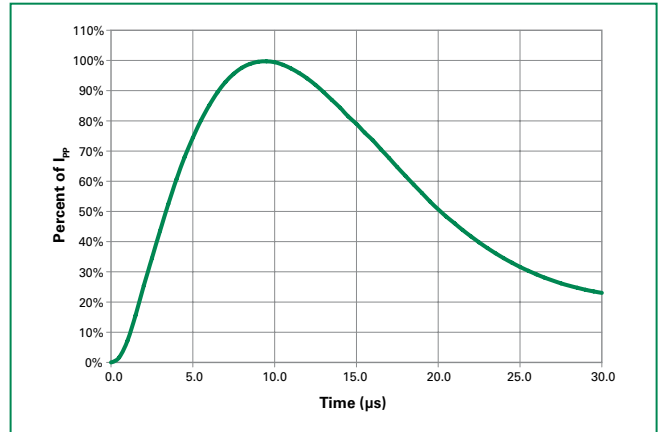

**SD05 Transmission Line Pulsing(TLP) Plot**

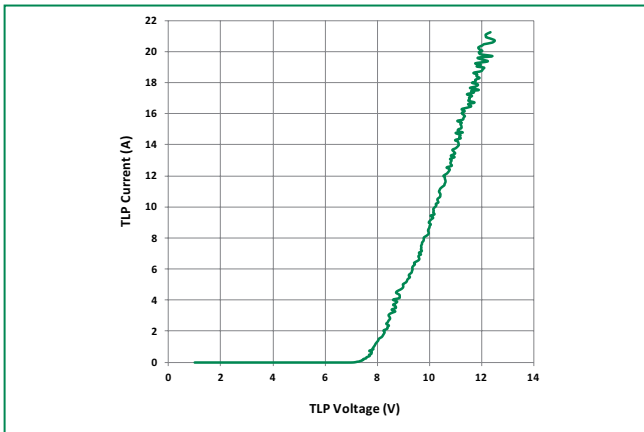

**SD12 Transmission Line Pulsing(TLP) Plot**

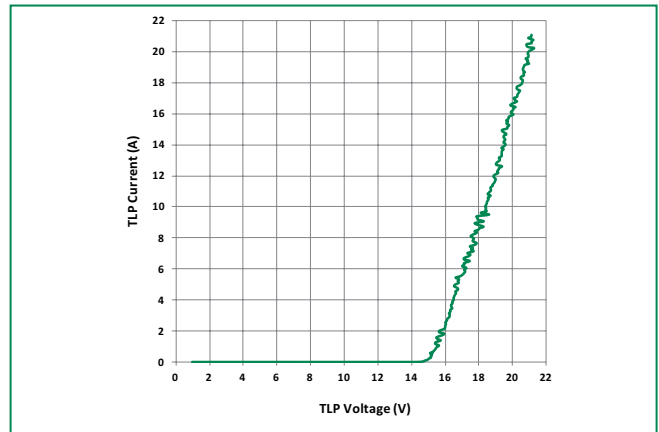

### SD15 Transmission Line Pulsing(TLP) Plot

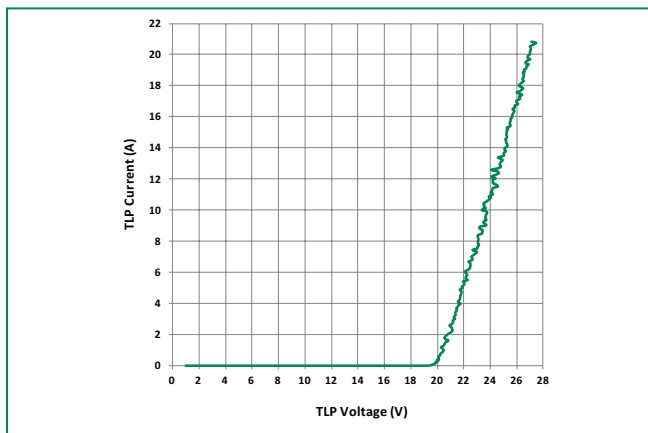

### SD24 Transmission Line Pulsing(TLP) Plot

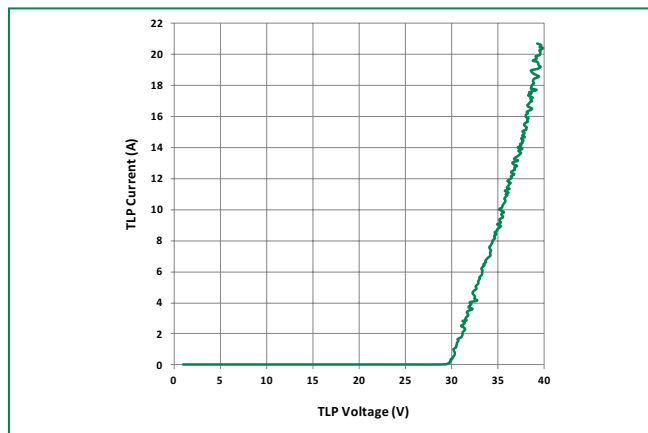

### SD36 Transmission Line Pulsing(TLP) Plot

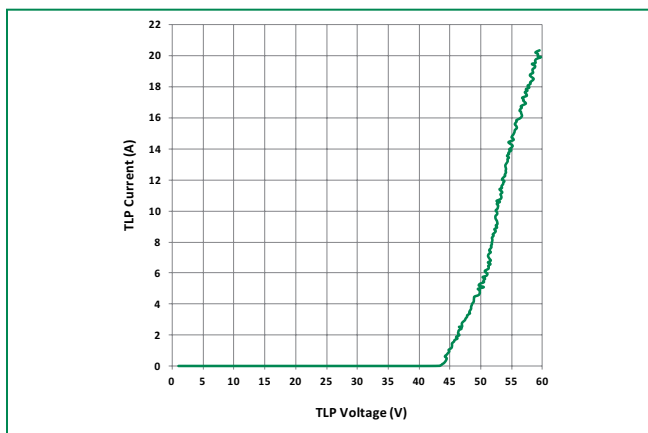

### Soldering Parameters

<b>Reflow Condition</b>		Pb – Free assembly
<b>Pre Heat</b>	- Temperature Min ( $T_{s(min)}$ )	150°C
	- Temperature Max ( $T_{s(max)}$ )	200°C
	- Time (min to max) ( $t_s$ )	60 – 180 secs
<b>Average ramp up rate (Liquidus) Temp (<math>T_L</math>) to peak</b>		3°C/second max
<b><math>T_{s(max)}</math> to <math>T_L</math> - Ramp-up Rate</b>		3°C/second max
<b>Reflow</b>	- Temperature ( $T_L$ ) (Liquidus)	217°C
	- Temperature ( $t_l$ )	60 – 150 seconds
<b>Peak Temperature (<math>T_p</math>)</b>		260 <sup>+0/-5</sup> °C
<b>Time within 5°C of actual peak Temperature (<math>t_p</math>)</b>		20 – 40 seconds
<b>Ramp-down Rate</b>		6°C/second max
<b>Time 25°C to peak Temperature (<math>T_p</math>)</b>		8 minutes Max.
<b>Do not exceed</b>		260°C

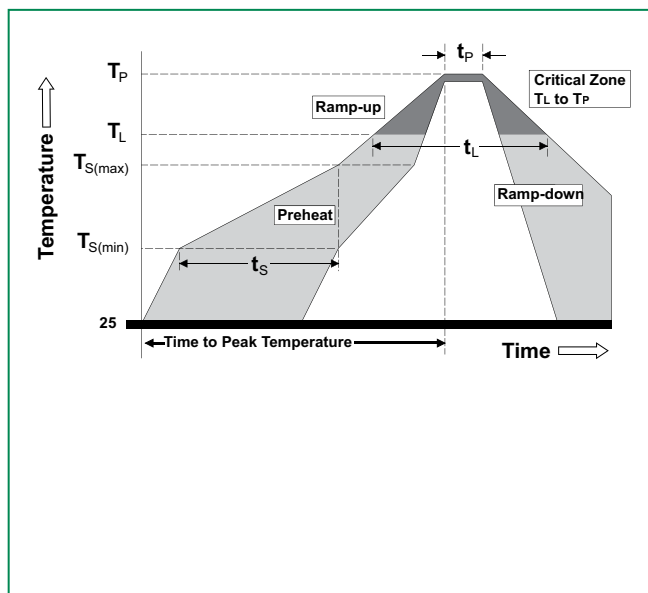

### Product Characteristics

<b>Lead Plating</b>	Matte Tin
<b>Lead Material</b>	Copper Alloy
<b>Lead Coplanarity</b>	0.0004 inches (0.102mm)
<b>Substrate material</b>	Silicon
<b>Body Material</b>	Molded Compound
<b>Flammability</b>	UL Recognized compound meeting flammability rating V-0

### Ordering Information

Part Number	Package	Min. Order Qty.
SD05-01FTG	SOD323	3000
SD12-01FTG	SOD323	3000
SD15-01FTG	SOD323	3000
SD24-01FTG	SOD323	3000
SD36-01FTG	SOD323	3000

### Part Marking System

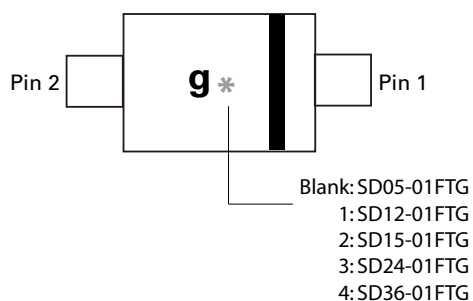

### Part Numbering System

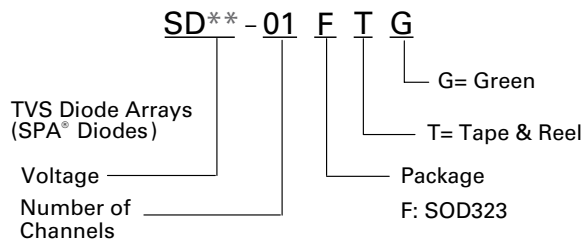

### Package Dimensions -SOD323

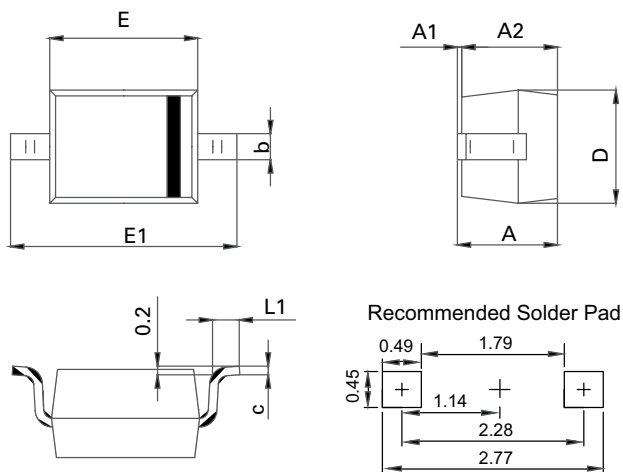

Unit: mm

Symbol	SOD323			
	Millimeters		Inches	
	Min	Max	Min	Max
<b>A</b>	0.8	1.14	0.031	0.045
<b>A1</b>	0.00	0.10	0.000	0.004
<b>A2</b>	0.80	1.04	0.031	0.014
<b>b</b>	0.25	0.35	0.010	0.014
<b>c</b>	0.08	0.15	0.003	0.006
<b>D</b>	1.15	1.45	0.045	0.057
<b>E</b>	1.60	1.90	0.063	0.075
<b>E1</b>	2.44	2.70	0.096	0.106
<b>L1</b>	0.25	0.45	0.010	0.018

**Embossed Carrier Tape & Reel Specification – SOD323**

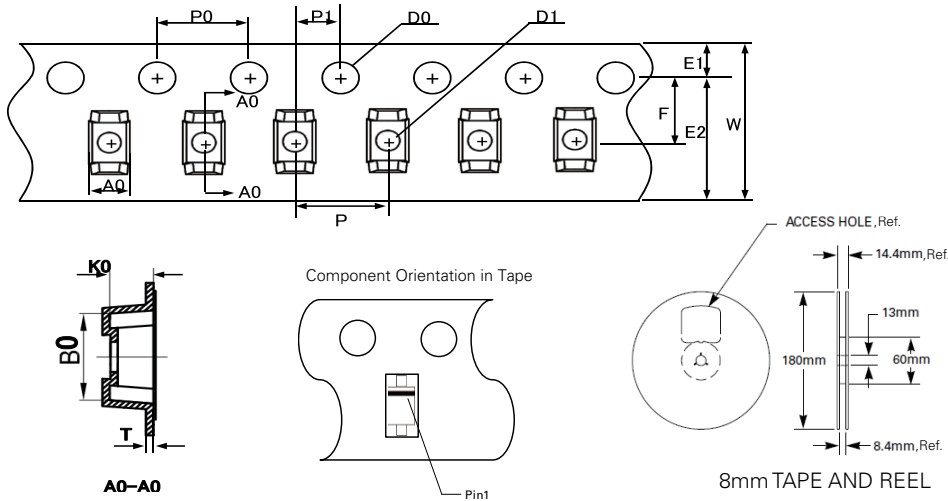

Symbol	Millimeters
<b>A0</b>	1.46+/-0.10
<b>B0</b>	2.90+/-0.10
<b>W</b>	8.0+0.3/-0.10
<b>D0</b>	1.50+0.10
<b>D1</b>	0.45min/1.15max
<b>E1</b>	1.75+/-0.10
<b>E2</b>	-
<b>F</b>	3.50+/-0.10
<b>P0</b>	4.00+/-0.10
<b>P</b>	4.00+/-0.10
<b>P1</b>	2.00+/-0.05
<b>K0</b>	1.25+/-0.10
<b>T</b>	0.254+/-0.02

8mm TAPE AND REEL