

SESD Series Ultra Low Capacitance Discrete TVS     

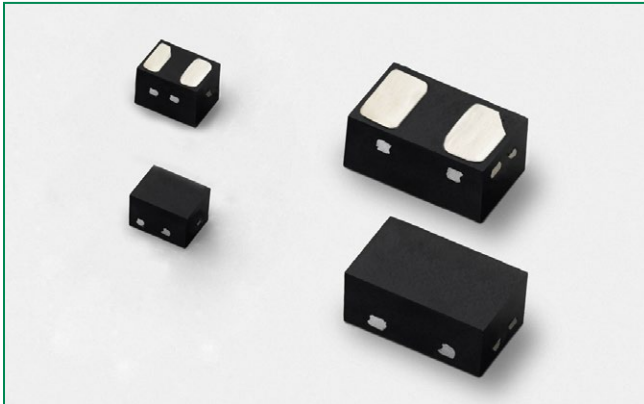

**Description**

The SESD Series Ultra Low Capacitance Discrete TVS provides unidirectional and bidirectional ESD protection for the most challenging high speed serial interfaces. Its low off-state capacitance, extremely low leakage (< 50 nA) and low dynamic resistance make it compatible with high speed signaling such as USB 3.1, HDMI 2.0, DisplayPort, and V-by-One®.

The SESD series has an ESD (IEC 61000-4-2) rating of ±20 kV packaged in the industry's popular 0402 and 0201 footprints.

**Pinout**

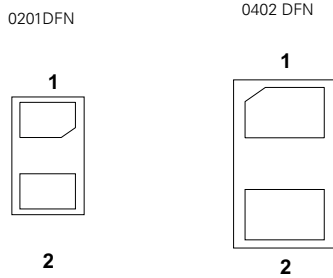

Bottom View

**Functional Block Diagram**



Unidirectional

Bidirectional

**Features**

- 0.15pF TYP bi-directional off-state capacitance (Bidirectional) ( $t_p=8/20\mu s$ )
- 0.30pF TYP uni-directional off-state capacitance
- IEC 61000-4-2 ESD rating of ±20 kV air and contact discharge
- Low clamping voltage of 14V @  $I_{pp}=2.5A$
- PPAP capable
- Low profile 0201 and 0402 DFN packages
- Facilitates excellent signal integrity
- ELV Compliant
- RoHS Compliant and Lead-free

**Applications**

- Ultra-high speed data lines
- USB 3.1, 3.0, 2.0
- HDMI 2.0, 1.4a, 1.3
- DisplayPort™
- Thunderbolt (Light Peak)
- V-by-One®
- LVDS interfaces
- Consumer, mobile and portable electronics
- Tablet PC and external storage with high speed interfaces
- Applications requiring high ESD performance in small packages

### Absolute Maximum Ratings

Symbol	Parameter	Value	Units
$I_{PP}$	Peak Current ( $t_p=8/20\mu s$ )	2.0	A
$T_{OP}$	Operating Temperature	-55 to 125	°C
$T_{STOR}$	Storage Temperature	-55 to 150	°C

CAUTION: Stresses above those listed in "Absolute Maximum Ratings" may cause permanent damage to the component. This is a stress only rating and operation of the component at these or any other conditions above those indicated in the operational sections of this specification is not implied.

### Unidirectional Electrical Characteristics - ( $T_{OP}=25^\circ C$ )

Parameter	Test Conditions	Min	Typ	Max	Units
Input Capacitance	Reverse Bias=0V, f = 3GHz	-	0.20	0.25	pF
Breakdown Voltage	$V_{BR}$ @ $I_T=1mA$	-	9.00	-	V
Reverse Working Voltage	-	-	-	7.0	V
Reverse Leakage Current	$I_L$ @ $V_{RWM}=5.0V$	-	25	50	nA
Clamping Voltage	$V_{CL}$ @ $I_{PP}=2.0A$	-	9.20	-	V
ESD Withstand Voltage	IEC 61000-4-2 (Contact)	±20	-	-	kV
	IEC 61000-4-2 (Air)	±20	-	-	

### Bidirectional Electrical Characteristics - ( $T_{OP}=25^\circ C$ )

Parameter	Test Conditions	Min	Typ	Max	Units
Input Capacitance	Reverse Bias=0V, f = 3GHz	-	0.10	0.13	pF
Breakdown Voltage	$V_{BR}$ @ $I_T=1mA$	-	9.80	-	V
Reverse Working Voltage	-	-7.0	-	7.0	V
Reverse Leakage Current	$I_L$ @ $V_{RWM}=5.0V$	-	25	50	nA
Clamping Voltage	$V_{CL}$ @ $I_{PP}=2.0A$	-	10.0	-	V
ESD Withstand Voltage	IEC 61000-4-2 (Contact)	±20	-	-	kV
	IEC 61000-4-2 (Air)	±20	-	-	

### Insertion Loss Diagram - Unidirectional

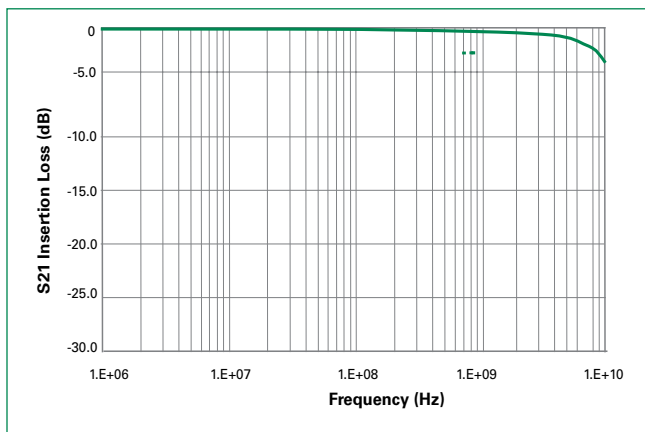

### Insertion Loss Diagram - Bidirectional

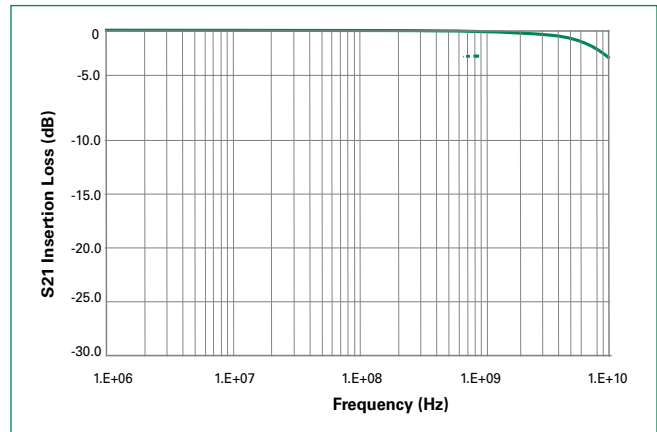

**Component IV Curve - Unidirectional**

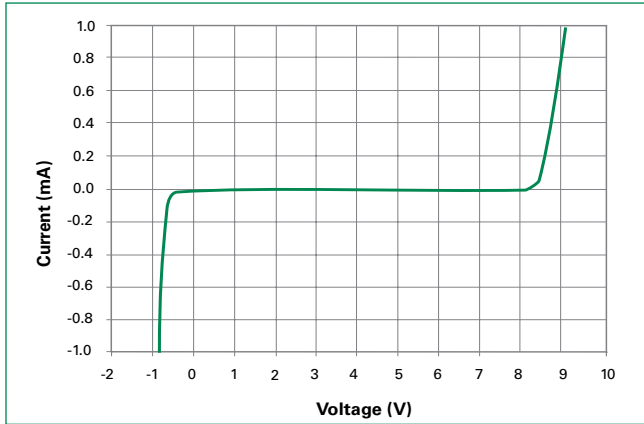

**Component IV Curve - Bidirectional**

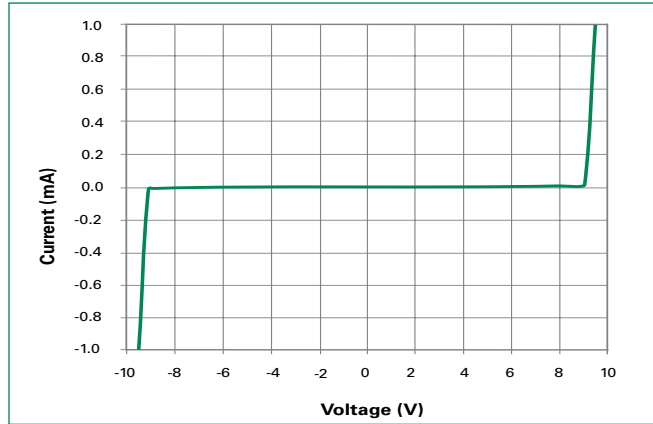

**USB3.0 Eye Diagram**

5.0 Gb/s, 1000mV differential, CPO Compliant Test Pattern

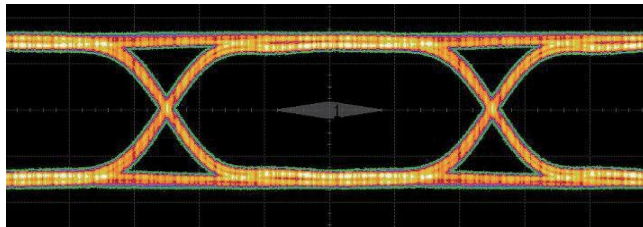

Without SESD Device

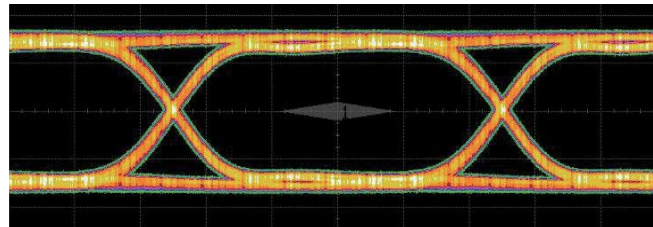

With SESD Device

**Soldering Parameters**

<b>Reflow Condition</b>		Pb – Free assembly
<b>Pre Heat</b>	- Temperature Min ( $T_{s(min)}$ )	150°C
	- Temperature Max ( $T_{s(max)}$ )	200°C
	- Time (min to max) ( $t_s$ )	60 – 180 secs
<b>Average ramp up rate (Liquidus) Temp (<math>T_L</math>) to peak</b>		3°C/second max
<b><math>T_{s(max)}</math> to <math>T_L</math> - Ramp-up Rate</b>		3°C/second max
<b>Reflow</b>	- Temperature ( $T_L$ ) (Liquidus)	217°C
	- Temperature ( $t_L$ )	60 – 150 seconds
<b>Peak Temperature (<math>T_p</math>)</b>		260 <sup>+0/-5</sup> °C
<b>Time within 5°C of actual peak Temperature (<math>t_p</math>)</b>		20 – 40 seconds
<b>Ramp-down Rate</b>		6°C/second max
<b>Time 25°C to peak Temperature (<math>T_p</math>)</b>		8 minutes Max.
<b>Do not exceed</b>		260°C

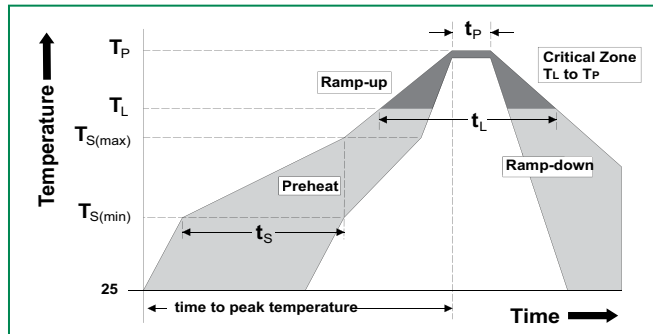

**Product Characteristics**

<b>Lead Plating</b>	Pre-Plated Frame
<b>Lead Material</b>	Copper Alloy
<b>Substrate material</b>	Silicon
<b>Body Material</b>	Molded Compound
<b>Flammability</b>	UL Recognized compound meeting flammability rating V-0

**Package Dimensions — 0201 DFN**

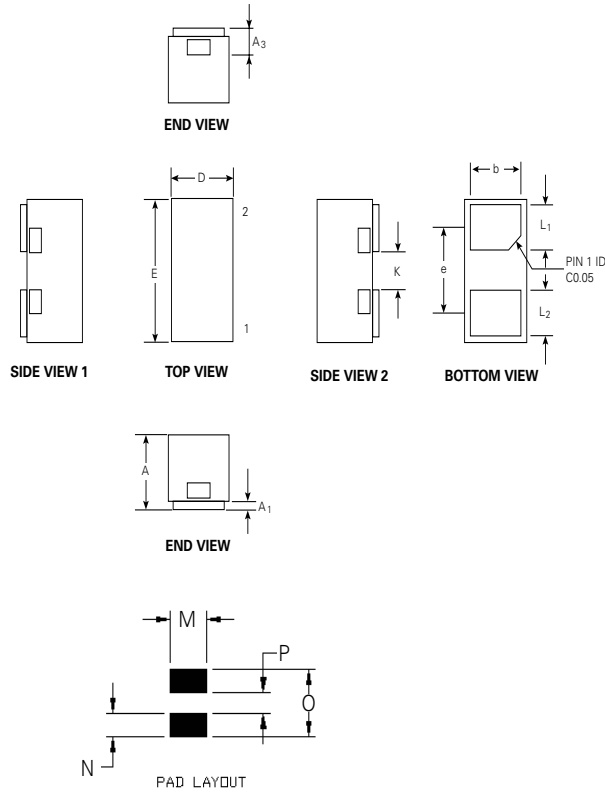

Symbol	Millimeters			Inches		
	Min	Typ	Max	Min	Typ	Max
A	0.28	0.30	0.32	0.011	0.012	0.013
A1	0	-	0.05	0	-	0.002
A3	0.102 ref.			0.004 ref.		
D	0.25	0.30	0.35	0.010	0.012	0.014
E	0.55	0.60	0.65	0.022	0.024	0.026
K	0.11	0.17	0.22	0.004	0.007	0.009
b	0.20	0.25	0.30	0.008	0.010	0.012
L1	0.13	0.18	0.23	0.005	0.008	0.009
L2	0.14	0.19	0.24	0.006	0.007	0.009
e	0.356 BSC			0.014 BSC		
M		0.32			0.013	
N		0.24			0.009	
O		0.62			0.024	
P		0.14			0.006	

**Package Dimensions — 0402 DFN**

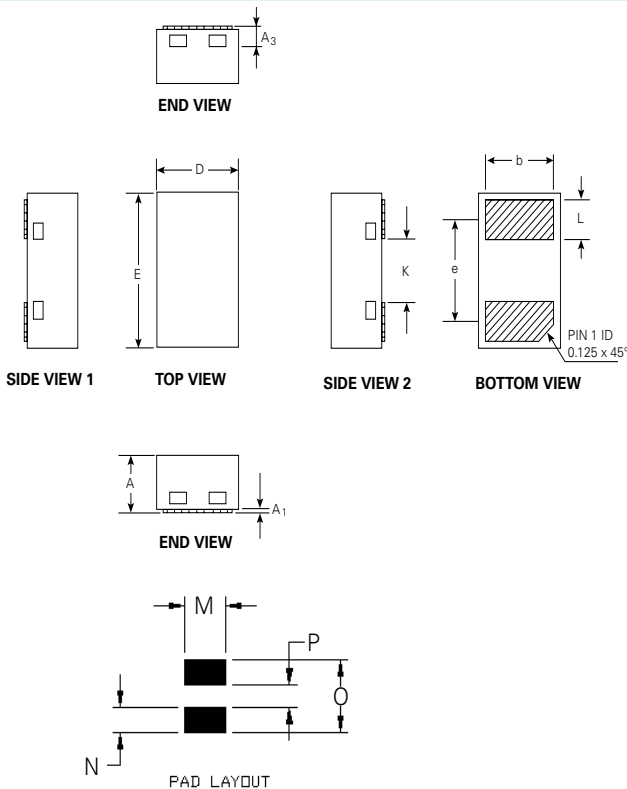

Symbol	Millimeters			Inches		
	Min	Typ	Max	Min	Typ	Max
A	0.33	0.38	0.43	0.013	0.015	0.017
A1	0	-	0.05	0	-	0.002
A3	0.13 ref.			0.005 ref.		
D	0.55	0.60	0.65	0.022	0.024	0.026
E	0.95	1.00	1.05	0.037	0.039	0.041
K	0.35	0.40	0.45	0.014	0.016	0.018
b	0.45	0.50	0.55	0.018	0.020	0.022
L	0.20	0.25	0.30	0.008	0.010	0.012
e	0.65 BSC			0.026 BSC		
M		0.60			0.024	
N		0.35			0.014	
O		1.00			0.039	
P		0.30			0.012	

**Part Numbering System**

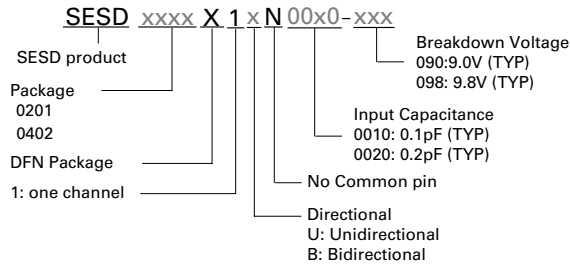

**Part Marking System**



Unidirectional

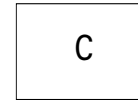

Bidirectional

**Ordering Information**

Part Number	Package	Ordering Part Number	Min. Order Qty.
SESD0201X1UN-0020-090	0201 DFN	RF2192-000	75000
SESD0201X1BN-0010-098	0201 DFN	RF2193-000	75000
SESD0402X1UN-0020-090	0402 DFN	RF2943-000	50000
SESD0402X1BN-0010-098	0402 DFN	RF2945-000	50000

**Embossed Carrier Tape & Reel Specification – 0201 DFN**

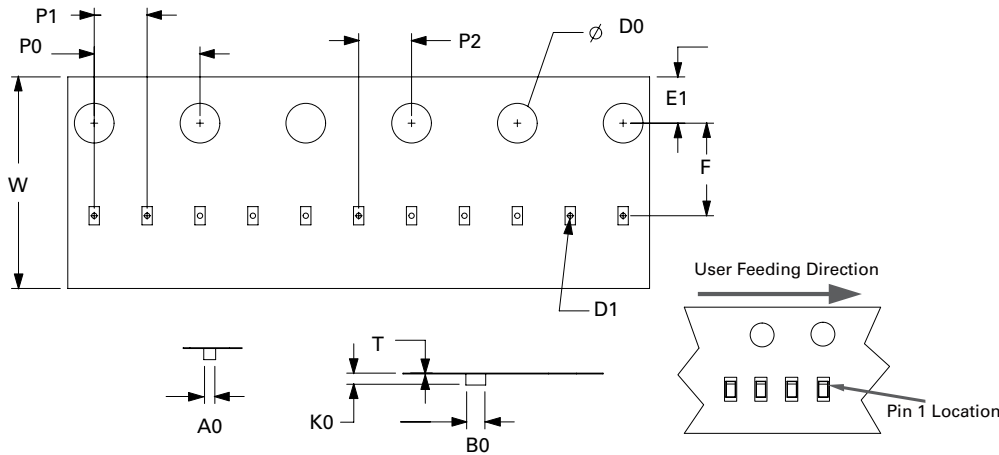

Symbol	Millimeters
A0	0.36+/-0.03
B0	0.66+/-0.03
D0	ø 1.50 +0.10/ -0
D1	ø 0.20 +/- 0.05
E1	1.75+/-0.10
F	3.50+/-0.05
K0	0.33+/-0.03
P0	4.00+/-0.10
P1	2.00+/-0.10
P2	2.00+/-0.05
W	8.00+/-0.10
T	0.23+/-0.02

**Embossed Carrier Tape & Reel Specification – 0402 DFN**

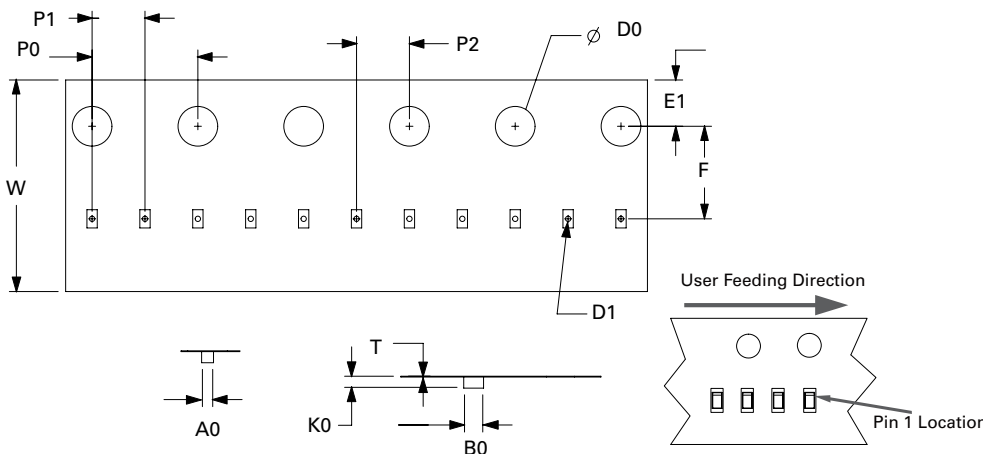

Symbol	Millimeters
A0	0.70+/-0.05
B0	1.15+/-0.05
D0	ø 1.55 + 0.05
D1	ø 0.40 +/- 0.05
E1	1.75+/-0.10
F	3.50+/-0.05
K0	0.47+/-0.05
P0	4.00+/-0.10
P1	2.00+/-0.10
P2	2.00+/-0.05
W	8.00+/-0.10
T	0.20+/-0.05