

SP1027 6.5pF 14kV Bidirectional Discrete TVS

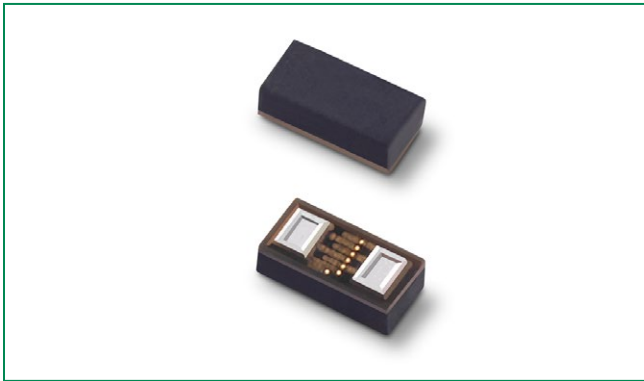

Description

The SP1027 bidirectional TVS is fabricated in a proprietary silicon avalanche technology. These diodes provide a high ESD (electrostatic discharge) protection level for electronic equipment. The SP1027 TVS can safely absorb repetitive ESD strikes of ± 14 kV (contact discharge as defined in IEC 61000-4-2) and ± 25 kV (air discharge as defined in IEC 61000-4-2) without any performance degradation. Additionally, each TVS can safely dissipate a 2A 8/20 surge event as defined in IEC 61000-4-5 2nd Edition. The back-to-back configuration provides symmetrical ESD protection.

Pinout

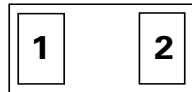

Features

- ESD, IEC 61000-4-2, ± 14 kV contact, ± 25 kV air
- EFT, IEC 61000-4-4, 40A (5/50ns)
- Lightning, 2A (8/20 as defined in IEC 61000-4-5 2nd edition)
- Low capacitance of 6.5pF (TYP @ $V_R=0V$)
- Low leakage current of $0.02\mu A$ (TYP) at 5V
- Space efficient 0201
- Halogen free, Lead free and RoHS compliant
- Moisture Sensitivity Level (MSL -1)

Functional Block Diagram

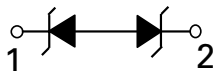

Applications

- Mobile Phones
- Smart Phones
- Camcorders
- Portable Medical
- Digital Cameras
- MP3
- Portable Navigation Components
- Tablets
- Point of Sale Terminals

Application Example

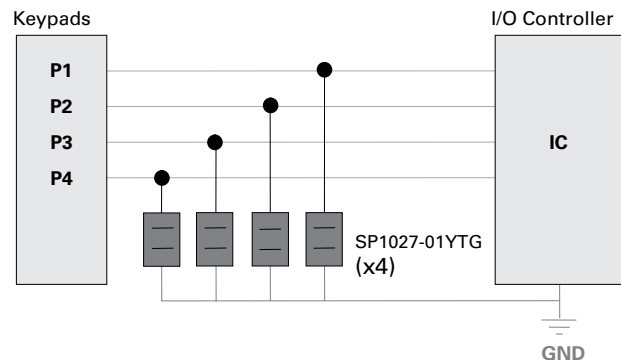

Life Support Note:

Not Intended for Use in Life Support or Life Saving Applications

The products shown herein are not designed for use in life sustaining or life saving applications unless otherwise expressly indicated.

Absolute Maximum Ratings

Symbol	Parameter	Value	Units
I_{PP}	Peak Current ($t_p=8/20\mu s$)	2.0	A
T_{OP}	Operating Temperature	-40 to 125	°C
T_{STOR}	Storage Temperature	-55 to 150	°C

CAUTION: Stresses above those listed in "Absolute Maximum Ratings" may cause permanent damage to the component. This is a stress only rating and operation of the component at these or any other conditions above those indicated in the operational sections of this specification is not implied.

Electrical Characteristics ($T_{OP}=25^\circ C$)

Parameter	Symbol	Test Conditions	Min	Typ	Max	Units
Reverse Standoff Voltage	V_{RWM}	$I_R=1\mu A$	-	-	5.0	V
Breakdown Voltage	V_{BR}	$I_R=1 mA$	6.0	7.9	-	V
Reverse Leakage Current	I_{LEAK}	$V_R=5V$	-	0.02	0.5	μA
Clamp Voltage ¹	V_C	$I_{PP}=1A, t_p=8/20\mu s, Fwd$	-	10.5	13.0	V
		$I_{PP}=2A, t_p=8/20\mu s, Fwd$	-	11.6	14.0	V
Dynamic Resistance ²	R_{DYN}	TLP, $t_p=100ns, I/O$ to GND	-	0.33	-	Ω
ESD Withstand Voltage ¹	V_{ESD}	IEC 61000-4-2 (Contact Discharge)	± 10	± 14	-	kV
		IEC 61000-4-2 (Air Discharge)	± 20	± 25	-	kV
Diode Capacitance ¹	$C_{I/O-I/O}$	Reverse Bias=0V, $f=1 MHz$	-	6.5	10.0	pF

Note:

- Parameter is guaranteed by design and/or component characterization.
- Transmission Line Pulse (TLP) with 100ns width, 2ns rise time, and average window $t_1=70ns$ to $t_2=90ns$

Capacitance vs. Reverse Bias

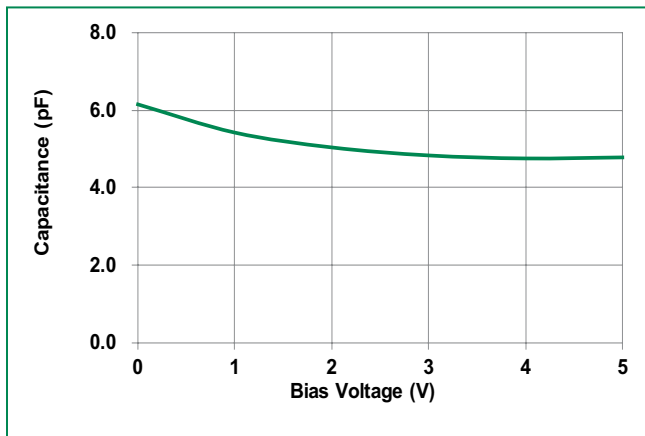

8/20 μs Pulse Waveform

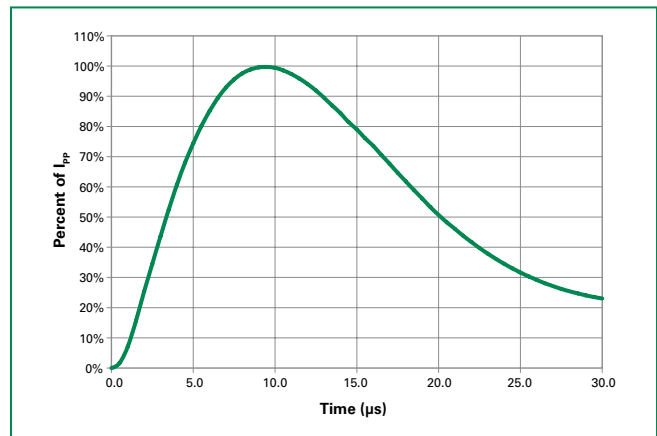

Negative Transmission Line Pulsing (TLP) Plot

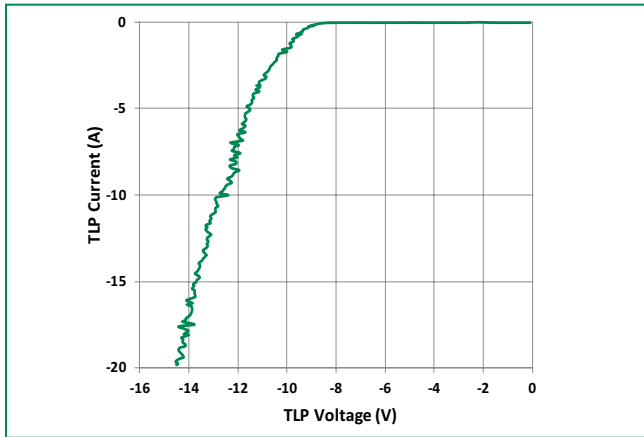

Positive Transmission Line Pulsing (TLP) Plot

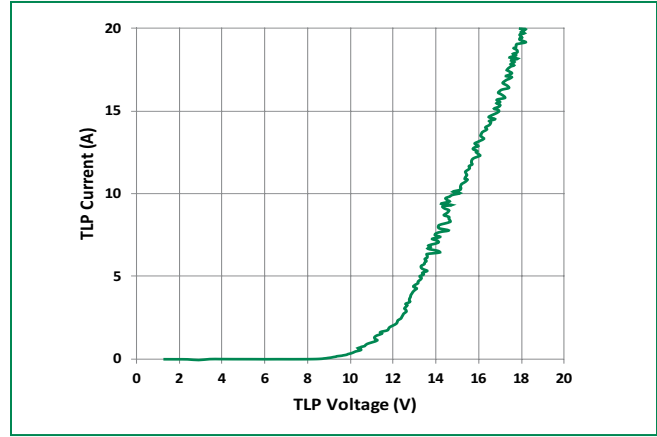

IEC 61000-4-2 -8 kV Contact ESD Clamping Voltage

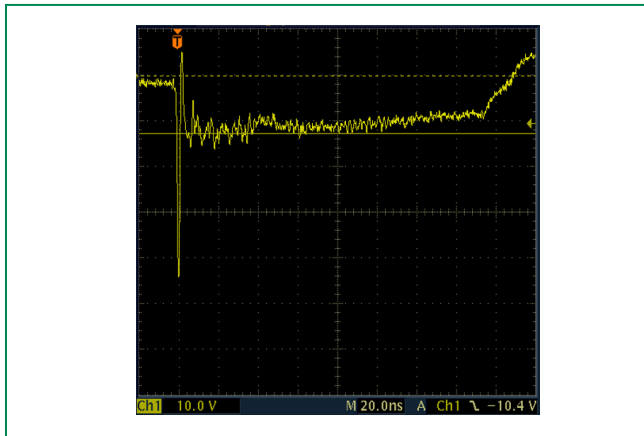

IEC 61000-4-2 +8 kV Contact ESD Clamping Voltage

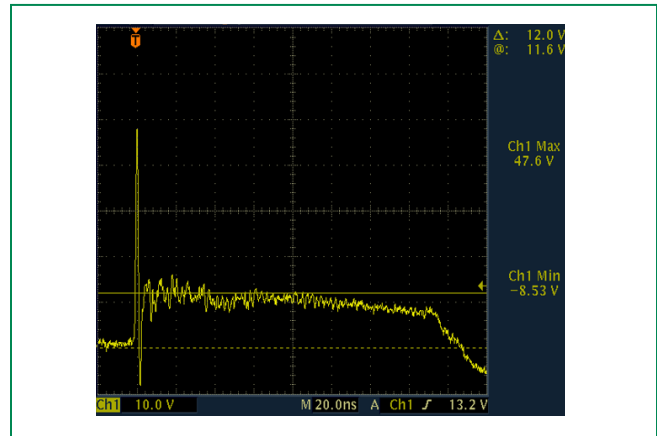

Clamping voltage vs. I_{pp} for 8/20 μ S waveshape

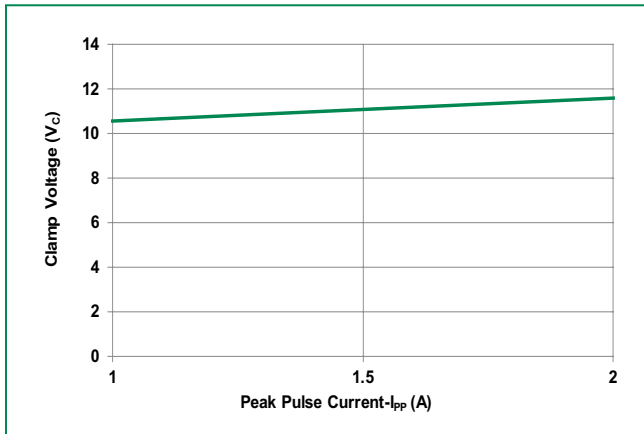

Soldering Parameters

Reflow Condition		Pb – Free assembly
Pre Heat	- Temperature Min ($T_{s(min)}$)	150°C
	- Temperature Max ($T_{s(max)}$)	200°C
	- Time (min to max) (t_s)	60 – 180 secs
Average ramp up rate (Liquidus) Temp (T_L) to peak		3°C/second max
$T_{s(max)}$ to T_L - Ramp-up Rate		3°C/second max
Reflow	- Temperature (T_L) (Liquidus)	217°C
	- Temperature (t_L)	60 – 150 seconds
Peak Temperature (T_p)		260 ^{+0/-5} °C
Time within 5°C of actual peak Temperature (t_p)		20 – 40 seconds
Ramp-down Rate		6°C/second max
Time 25°C to peak Temperature (T_p)		8 minutes Max.
Do not exceed		260°C

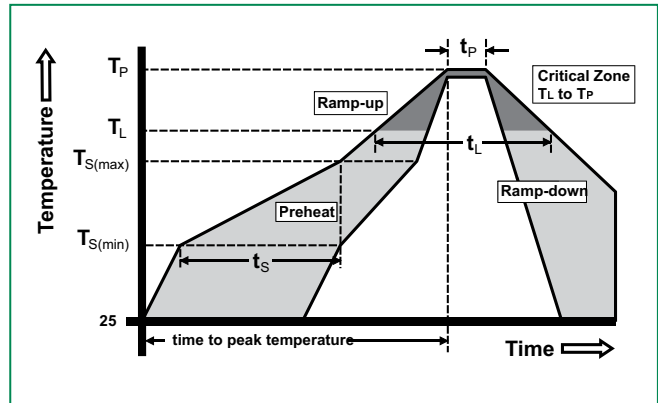

Ordering Information

Part Number	Package	Min. Order Qty.
SP1027-01YTG	0201 ECP	10000

Product Characteristics

Lead Plating	Tin
Substrate material	Silicon
Body Material	Molded Compound
Flammability	UL Recognized compound meeting flammability rating V-0

Part Marking System



Part Numbering System

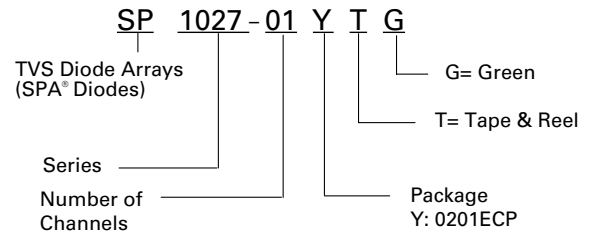

Package Dimensions — 0201 ECP

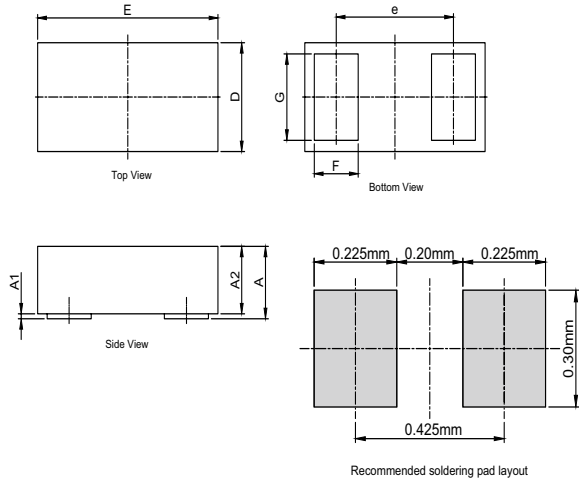

Symbol	0201 ECP					
	Millimeters			Inches		
	Min	Typ	Max	Min	Typ	Max
A	0.175	0.200	0.225	0.0069	0.0079	0.0089
A1	0.008	0.011	0.014	0.0003	0.0004	0.0006
A2	0.167	0.189	0.211	0.0066	0.0074	0.0083
e	0.360 BSC			0.0142 BSC		
D	0.270	0.300	0.330	0.0106	0.0118	0.0130
E	0.570	0.600	0.630	0.0224	0.0236	0.0248
F	0.130	0.140	0.150	0.0051	0.0055	0.0059
G	0.190	0.200	0.210	0.0075	0.0079	0.0083

Embossed Carrier Tape & Reel Specification — 0201 ECP

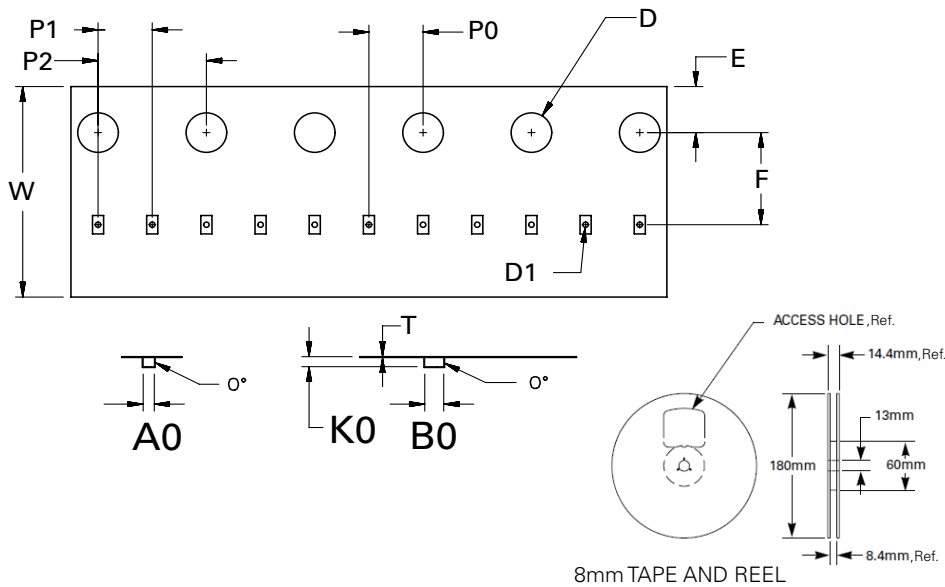

Symbol	Millimeters
A0	0.41+/-0.03
B0	0.70+/-0.03
D	∅ 1.50 + 0.10
D1	∅ 0.20 +/- 0.05
E	1.75+/-0.10
F	3.50+/-0.05
K0	0.38+/-0.03
P0	2.00+/-0.05
P1	2.00+/-0.05
P2	4.00+/-0.10
W	8.00 + 0.30 -0.10
T	0.23+/-0.02

Disclaimer Notice - Information furnished is believed to be accurate and reliable. However, users should independently evaluate the suitability of and test each product selected for their own applications. Littelfuse products are not designed for, and may not be used in, all applications. Read complete Disclaimer Notice at <http://www.littelfuse.com/disclaimer-electronics>.