

# SP3374NUTG 3.3V 40A Diode Array

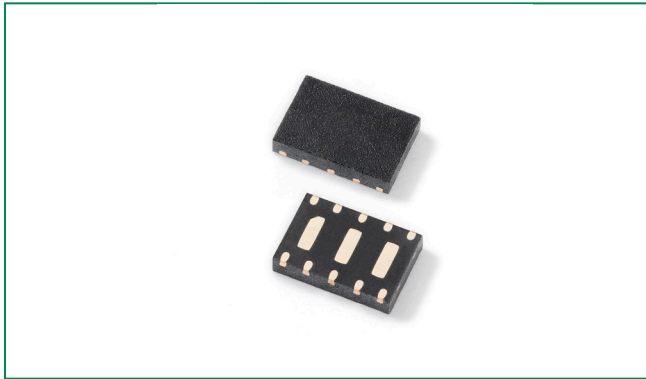

## Description

The SP3374NUTG is a low-capacitance, TVS Diode Array designed to provide protection against ESD (electrostatic discharge), CDE (cable discharge events), EFT (electrical fast transients), and lightning induced surges for high-speed, differential data lines. It's packaged in a μDFN package (3.0 x 2.0mm) and each device can protect up to 4 channels or 2 differential pairs, up to 40A (IEC 61000-4-5 2<sup>nd</sup> edition,) and up to 30kV ESD (IEC 61000-4-2). The "flow-through" design minimizes signal distortion, reduces voltage overshoot, and provides a simplified PCB design.

The SP3374NUTG with its low capacitance and low clamping voltage makes it ideal for high-speed data interfaces such as 1GbE applications found in notebooks, switches, etc.

## Pinout

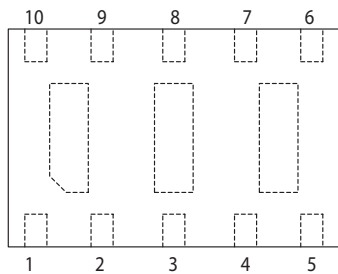

## Features

- ESD, IEC 61000-4-2, ±30kV contact, ±30kV air
- EFT, IEC 61000-4-4, 40A (5/50ns)
- Lightning, IEC 61000-4-5 2<sup>nd</sup> edition, 40A ( $t_p=8/20\mu s$ )
- Low capacitance of 3.5pF@0V (TYP) per I/O
- Low leakage current of 0.1μA (TYP) at 3.3V
- μDFN-10 package is optimized for high-speed data line routing
- Provides protection for two differential data pairs (4 channels) up to 40A
- Low operating and clamping voltage
- AEC-Q101 qualified
- Halogen free, Lead free and RoHS compliant

## Functional Block Diagram

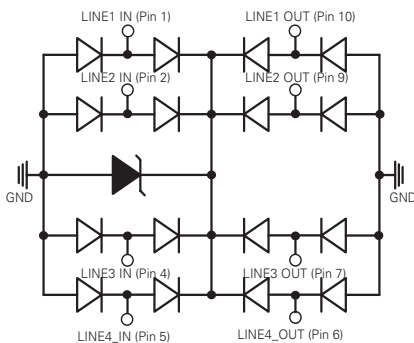

## Applications

- 10/100/1000 Ethernet
- WAN/LAN Equipment
- Desktops, Servers and Notebooks
- LVDS Interfaces
- Integrated Magnetics
- Smart TV

## Application Example

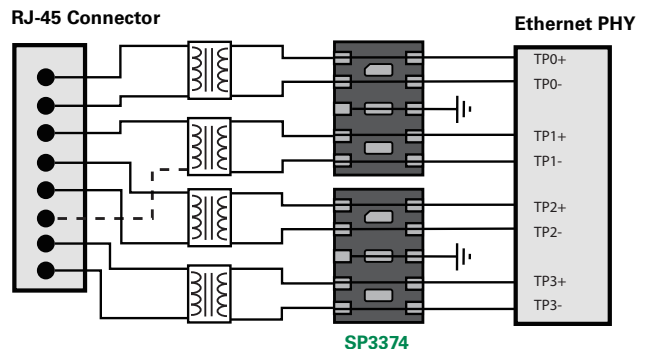

Life Support Note:

**Not Intended for Use in Life Support or Life Saving Applications**

The products shown herein are not designed for use in life sustaining or life saving applications unless otherwise expressly indicated.

### Absolute Maximum Ratings

Symbol	Parameter	Value	Units
$I_{PP}$	Peak Current ( $t_p=8/20\mu s$ )	40	A
$P_{PK}$	Peak Pulse Power ( $t_p=8/20\mu s$ )	1000	W
$T_{OP}$	Operating Temperature	-40 to 125	°C
$T_{STOR}$	Storage Temperature	-55 to 150	°C

CAUTION: Stresses above those listed in "Absolute Maximum Ratings" may cause permanent damage to the device. This is a stress only rating and operation of the device at these or any other conditions above those indicated in the operational sections of this specification is not implied.

### Electrical Characteristics ( $T_{OP}=25^\circ C$ )

Parameter	Symbol	Test Conditions	Min	Typ	Max	Units
Reverse Standoff Voltage	$V_{RWM}$	$I_R \leq 1\mu A$			3.3	V
Reverse Leakage Current	$I_R$	$V_{RWM} = 3.3V, T = 25^\circ C$		0.1	0.5	$\mu A$
Snap Back Voltage	$V_{SB}$	$I_{SB} = 50mA$	2.8			V
Clamp Voltage	$V_C$	$I_{PP} = 1A, t_p = 8/20\mu s$ Any I/O to Ground			5.5	V
		$I_{PP} = 10A, t_p = 8/20\mu s$ Any I/O to Ground			10.5	
		$I_{PP} = 25A, t_p = 8/20\mu s$ Any I/O to Ground			18.0	
		$I_{PP} = 40A, t_p = 8/20\mu s$ Line-to-Line <sup>1</sup> , two I/O Pins connected together on each line			25.0	
Dynamic Resistance <sup>2</sup>	$R_{DYN}$	TLP, $t_p=100ns$ , Any I/O to Ground		0.15		$\Omega$
ESD Withstand Voltage	$V_{ESD}$	IEC 61000-4-2 (Contact)	$\pm 30$			kV
		IEC 61000-4-2 (Air)	$\pm 30$			kV
Diode Capacitance	$C_{I/O \text{ to GND}}$	Between I/O Pins and Ground $V_R = 0V, f = 1MHz$		3.5	5.0	pF
	$C_{I/O \text{ to I/O}}$	Between I/O Pins $V_R = 0V, f = 1MHz$		1.7		pF

#### Notes:

- Rating with 2 pins connected together per suggested diagram ( For example, pin1 is connected to pin 10, pin 2 is connected to Pin 9, Pin 4 is connected to pin 7 and pin 5 is connected to pin 6)
- Transmission Line Pulse (TLP) with 100ns width, 2ns rise time, and average window  $t_1=70ns$  to  $t_2= 90ns$

**Capacitance vs. Reverse Bias**

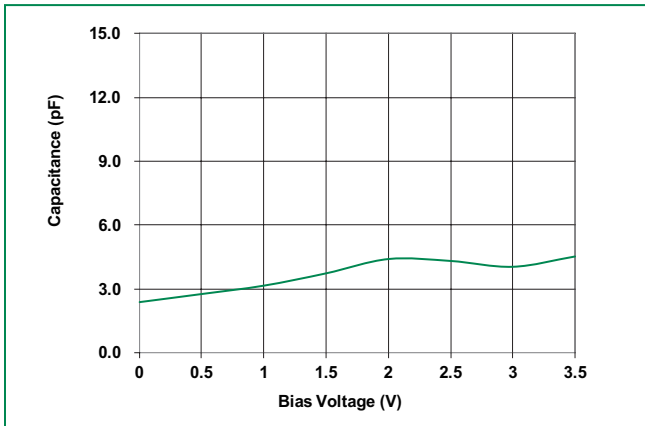

**Clamping Voltage vs.  $I_{PP}$  (I/O to GND)**

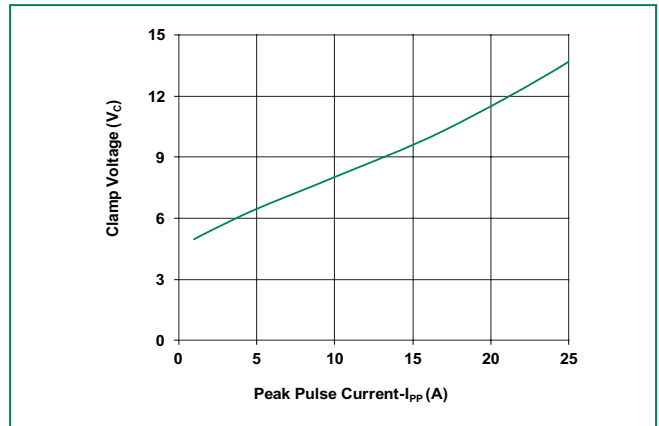

**Clamping Voltage vs.  $I_{PP}$  (Line-to-Line)**

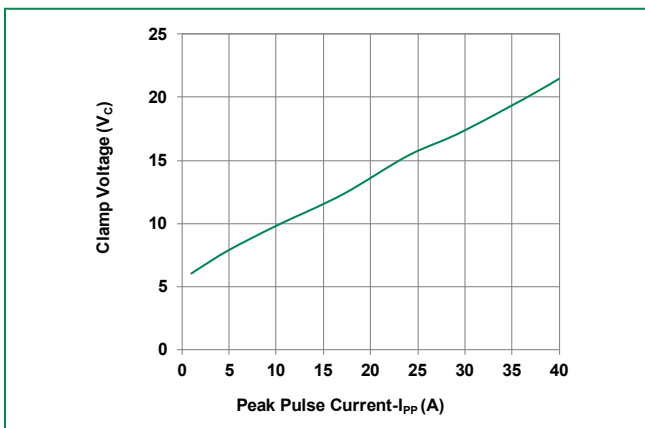

**8/20μS Pulse Waveform**

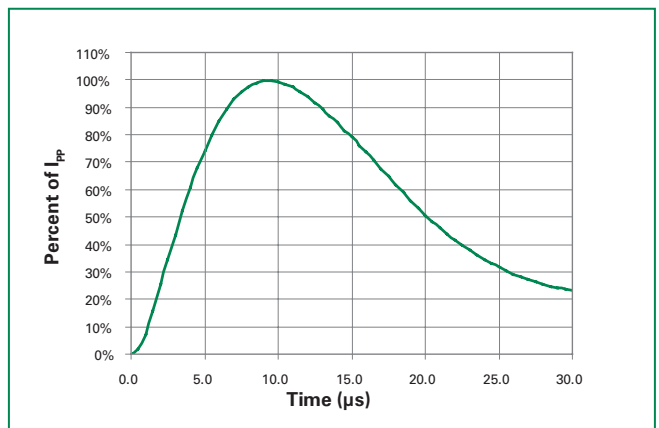

**Transmission Line Pulsing(TLP) Plot**

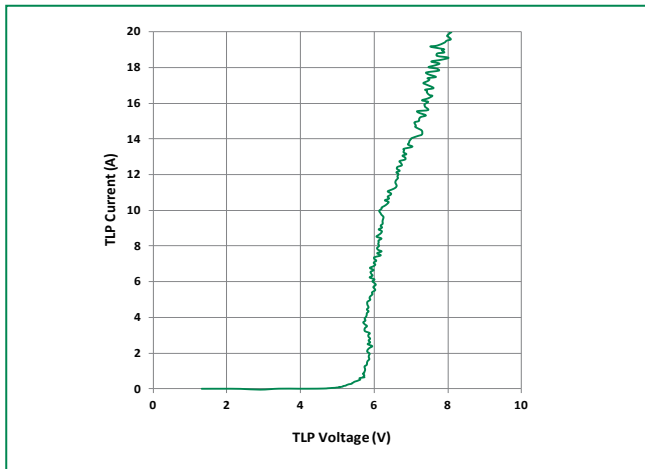

### Soldering Parameters

Reflow Condition		Pb – Free assembly
Pre Heat	- Temperature Min ( $T_{s(min)}$ )	150°C
	- Temperature Max ( $T_{s(max)}$ )	200°C
	- Time (min to max) ( $t_s$ )	60 – 180 secs
Average ramp up rate (Liquidus) Temp ( $T_L$ ) to peak		3°C/second max
$T_{s(max)}$ to $T_L$ - Ramp-up Rate		3°C/second max
Reflow	- Temperature ( $T_L$ ) (Liquidus)	217°C
	- Temperature ( $t_L$ )	60 – 150 seconds
Peak Temperature ( $T_p$ )		260 <sup>+0/-5</sup> °C
Time within 5°C of actual peak Temperature ( $t_p$ )		20 – 40 seconds
Ramp-down Rate		6°C/second max
Time 25°C to peak Temperature ( $T_p$ )		8 minutes Max.
Do not exceed		260°C

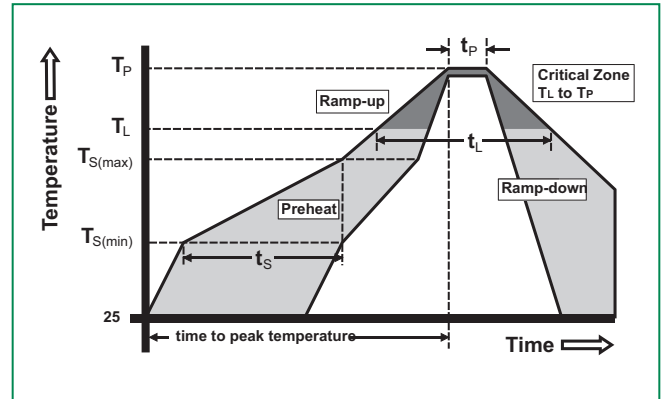

### Ordering Information

Part Number	Package	Marking	Min. Order Qty.
SP3374NUTG	$\mu$ DFN-10 (3.0x2.0mm)	<u>b</u> G4	3000

### Product Characteristics

<b>Lead Plating</b>	Pre-Plated Frame
<b>Lead Material</b>	Copper Alloy
<b>Lead Coplanarity</b>	0.004 inches(0.102mm)
<b>Substrate material</b>	Silicon
<b>Body Material</b>	Molded Epoxy
<b>Flammability</b>	UL 94 V-0
<b>MSL Rating</b>	Level 1

### Part Numbering System

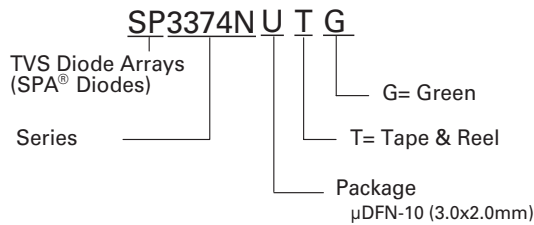

### Part Marking System

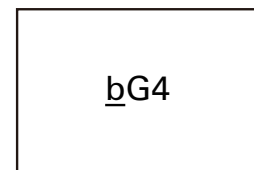

**Package Dimensions —  $\mu$ DFN-10 (3.0x2.0mm)**

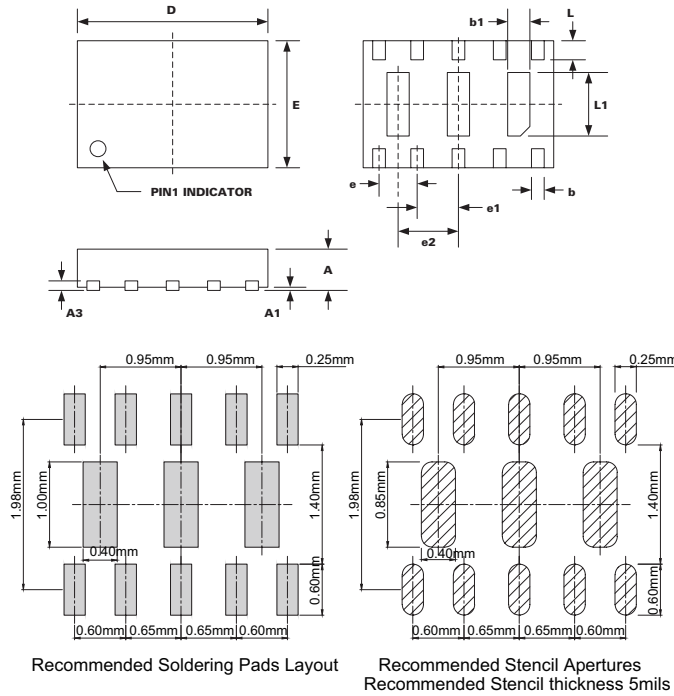

Package	$\mu$ DFN-10 (3.0x2.0mm)					
JEDEC	MO-229					
Symbol	Millimeters			Inches		
	Min	Nom	Max	Min	Nom	Max
<b>A</b>	0.50	0.60	0.65	0.020	0.024	0.026
<b>A1</b>	0.00	0.03	0.05	0.000	0.001	0.002
<b>A3</b>	0.15 Ref			0.006 Ref		
<b>b</b>	0.15	0.20	0.25	0.006	0.008	0.010
<b>b1</b>	0.25	0.35	0.45	0.010	0.014	0.018
<b>D</b>	2.90	3.00	3.10	0.114	0.118	0.122
<b>E</b>	1.90	2.00	2.10	0.075	0.079	0.083
<b>e</b>	0.60 BSC			0.024 BSC		
<b>e1</b>	0.65 BSC			0.026 BSC		
<b>e2</b>	0.95 BSC			0.037		
<b>L</b>	0.25	0.30	0.35	0.010	0.012	0.014
<b>L1</b>	0.95	1.00	1.05	0.037	0.039	0.041

Notes :

1. All dimensions are in millimeters
2. Dimensions include solder plating.
3. Dimensions are exclusive of mold flash & metal burr.
4. Blo is facing up for mold and facing down for trim/form, i.e. reverse trim/form.
5. Package surface matte finish VDI 11-13.

**Tape & Reel Specification —  $\mu$ DFN-10 (3.0x2.0mm)**

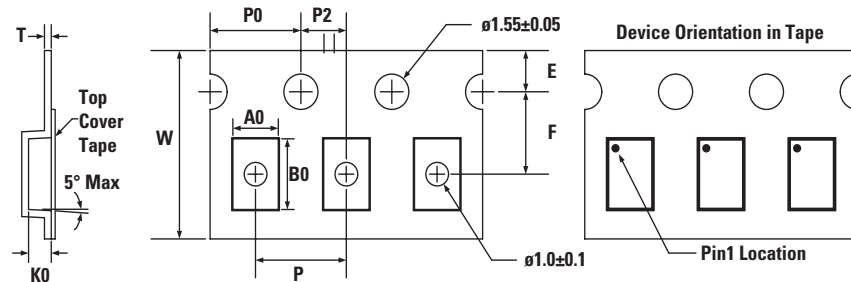

Package	$\mu$ DFN-10 (3.0x2.0mm)
Symbol	Millimeters
<b>A0</b>	2.30 +/- 0.10
<b>B0</b>	3.20 +/- 0.10
<b>E</b>	1.75 +/- 0.10
<b>F</b>	3.50 +/- 0.05
<b>K0</b>	1.0 +/- 0.10
<b>P</b>	4.00 +/- 0.10
<b>P0</b>	4.00 +/- 0.10
<b>P2</b>	2.00 +/- 0.10
<b>T</b>	0.3 +/- 0.05
<b>W</b>	8.00 +0.30/- 0.10