

FBMOV Varistor Series

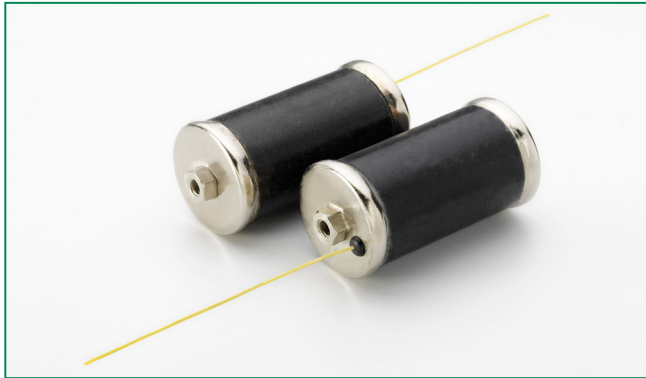

Description

The Littelfuse FBMOV Series thermally protected and non-fragmenting varistor represents a new development in circuit protection. It consists of a 40kA varistor building block (MOV) with an integral thermally activated element designed to open in the event of overheating due to abnormal over-voltage, limited current conditions.

FBMOV series devices also include a varistor series fuse which prevents the part from rupturing when subjected to high fault current (up to 200kA). The tubular fuse-like body allows for easy mechanical connection in the application.

Another feature of FBMOV is an indicator lead, which may be connected to monitoring circuitry and used to signal if the MOV has been disconnected.

FBMOV series devices offer quick thermal response due to the close proximity of the integrated fusing thermal element to the MOV body. The integrated configuration also offers lower inductance than most discreet solutions resulting in improved clamping performance to fast over-voltage transients.

Applications

- Type 1 SPD (Surge Protection Device) Products
- Power supplies
- Transformer
- Residential Service Panel
- Power distribution
- Telecommunication
- IT/Data Center

Absolute Maximum Ratings

• For ratings of individual members of a series, see Device Ratings and Specifications chart

Continuous:	FBMOV Series	Units
Steady State Applied Voltage:		
DC Voltage Range (V_{MIDC})	150 to 970	V
AC Voltage Range ($V_{M(AC)RMS}$)	115 to 750	V
Transient:		
Non-Repetitive Surge Current, 8/20 μ s Waveform (I_{TM})	40,000	A
Non-Repetitive Energy Capability, 2ms Waveform (W_{TM})	340 to 1340	J
Operating Ambient Temperature Range (T_A)	-55 to +85	°C
Storage Temperature Range (T_{STG})	-55 to +125	°C
Temperature Coefficient (α^V) of Clamping Voltage (V_C) at Specified Test Current	<0.01	%/°C
Hi-Pot Encapsulation (Isolation Voltage Capability)	2500	V
COATING Insulation Resistance	>1000	M Ω

Features

- RoHS compliant and Lead-free
- Will open circuit without rupture during UL 1449 Intermediate Current Test of 100A, 500A and 1,000A, and Short Circuit Current Test of 200,000A
- Indicator Lead for monitoring MOV

Additional Information



Datasheet



Resources



Samples

FBMOV Series Ratings & Specifications

Part Number	Maximum Rating (85°C)				Specifications (25°C)				
	Continuous		Transient		Varistor Voltage at 1mA DC Test Current			Maximum Clamping Volt V_C at 200A Current (8/20 μ s)	Typical Capacitance $f = 1$ MHz
	AC Volts	DC Volts	Energy (2ms)	Peak Current 8 x 20 μ s					
	$V_{M(AC)RMS}$	$V_{M(DC)}$	W_{TM}	I_{TM}	Min	$V_{N(DC)}$	Max	V_C	C
(V)	(V)	(J)	(A)	(V)	(V)	(V)	(V)	(pF)	
FBMOV115M	115	150	340	40000	162	180	198	295	6400
FBMOV130M	130	170	380	40000	184.5	205	225.5	335	5600
FBMOV140M	140	180	420	40000	198	220	242	355	5000
FBMOV150M	150	200	440	40000	216	240	264	390	4600
FBMOV175M	175	225	500	40000	243	270	297	450	3800
FBMOV230M	230	300	600	40000	324	360	396	585	3000
FBMOV250M	250	320	660	40000	351	390	429	640	2800
FBMOV275M	275	350	700	40000	387	430	473	700	2500
FBMOV300M	300	385	740	40000	423	470	517	765	2300
FBMOV320M	320	420	780	40000	459	510	561	825	2160
FBMOV385M	385	505	860	40000	558	620	682	1010	1800
FBMOV420M	420	560	920	40000	612	680	748	1100	1640
FBMOV440M	440	585	940	40000	643.5	715	786.5	1160	1580
FBMOV460M	460	615	980	40000	675	750	825	1220	1500
FBMOV510M	510	670	1040	40000	738	820	902	1335	1360
FBMOV550M	550	745	1100	40000	819	910	1001	1475	1260
FBMOV625M	625	825	1200	40000	900	1000	1100	1625	1110
FBMOV750M	750	970	1340	40000	1080	1200	1320	1950	920

NOTE: Average power dissipation of transients not to exceed 2.5W. See Figures 3 and 4 for more information on power dissipation.

Peak Current, Energy and Power De-rating Curve

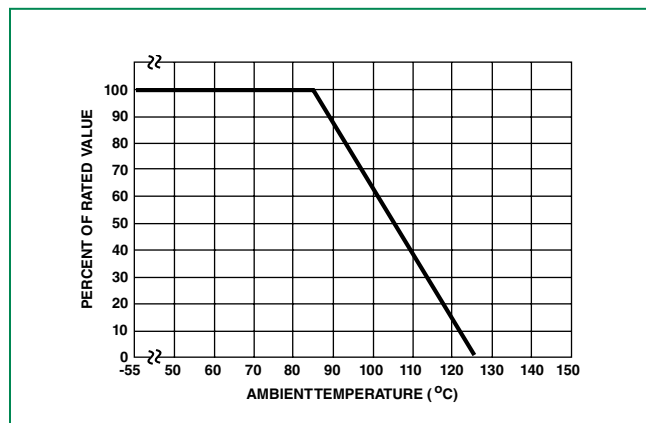

For applications exceeding 85° C, ambient temperatures, the peak surge current and energy rating must be reduced as shown in Figure 1.

Peak Pulse Current Test Waveform

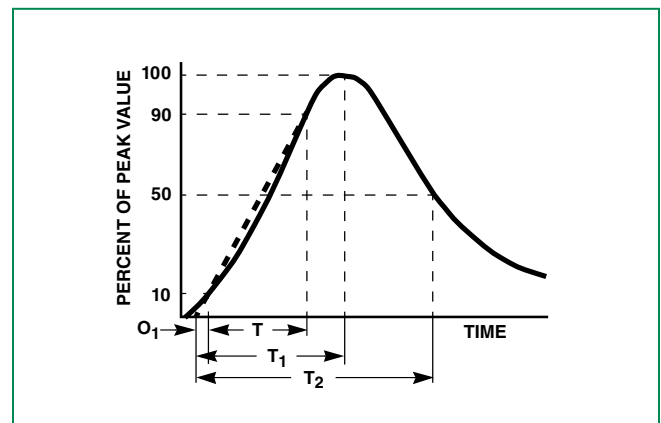

O_1 = Virtual Origin of Wave
 T = Time from 10% to 90% of Peak
 T_1 = Rise Time = $1.25 \times T$
 T_2 = Decay Time

Example - For an 8/20 μ s Current Waveform:

$8\mu s = T_1 = \text{Rise Time}$
 $20\mu s = T_2 = \text{Decay Time}$

V-I Characteristic Curves

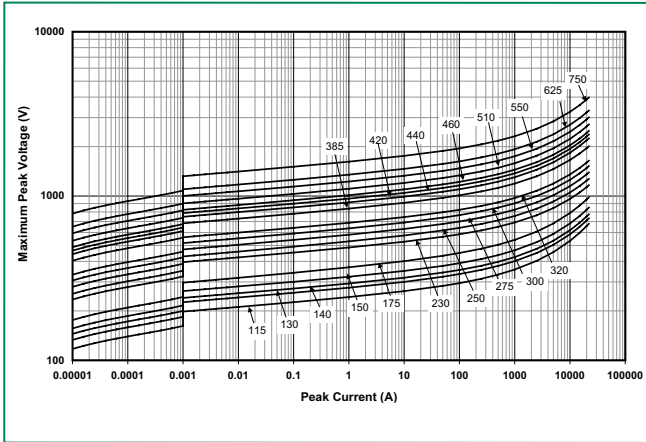

Pulse Rating Curves

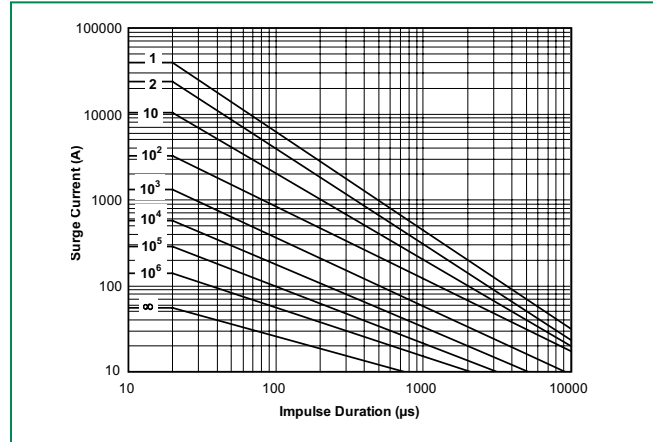

Dimensions

Typical Dimensions in Millimeters [Inches]

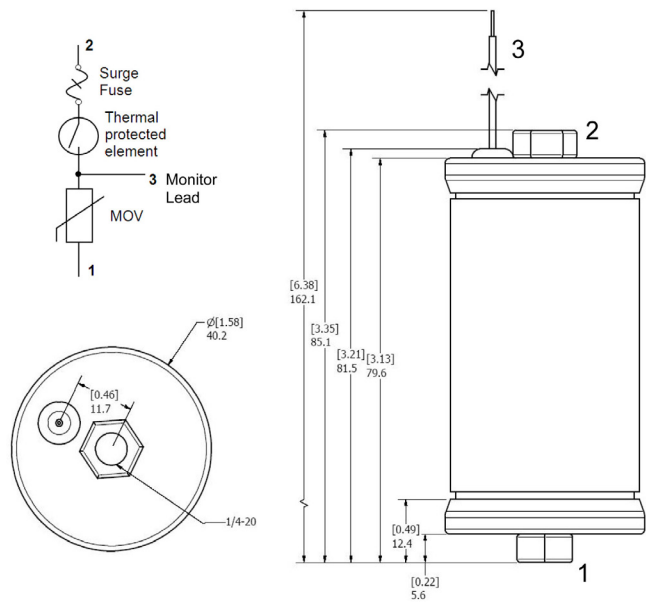

Part Numbering System

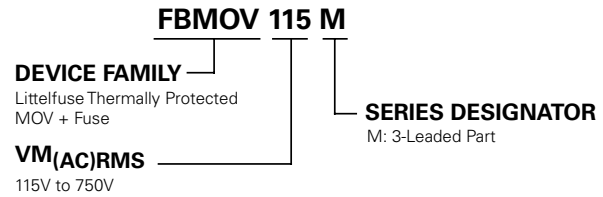

Disclaimer Notice - Information furnished is believed to be accurate and reliable. However, users should independently evaluate the suitability of and test each product selected for their own applications. Littelfuse products are not designed for, and may not be used in, all applications. Read complete Disclaimer Notice at www.littelfuse.com/disclaimer-electronics.