

Installation Instructions for ISS-102CCI-M-MC Intrinsically-Safe Switch

WARNING: TO PREVENT IGNITION OF FLAMMABLE OR COMBUSTABLE ATMOSPHERES, DISCONNECT POWER FROM THE SYSTEM PRIOR TO INSTALLATION OR SERVICE.

CAUTION: Installation must comply with all national, state, and local codes. Installation of this equipment should only be performed by personnel trained in intrinsically-safe systems. Improper installation may result in serious injury or damage. Before proceeding with installation, read and understand these instructions completely.

The ISS-102 Isolated Switch has been evaluated by MSHA (18-ISA070001-0) as an associated apparatus for interfacing between hazardous and non-hazardous areas. The ISS-102 must be installed in a non-hazardous area. Consult MSHA for approval for use in any associated equipment, and follow SymCom's Control Drawing ISS-102CCI-M on page 4 for proper installation.

All wiring connected to a hazardous location must be separated from all non-intrinsically-safe wiring. Description of special wiring methods can be found in the National Electrical Code ANSI/NFPA 70, Article 504 Intrinsically-Safe Systems. Check your state and local codes for additional requirements.

WARNING: REMOVE POWER FROM THE SYSTEM PRIOR TO INSTALLING OR SERVICING THE ISS-102.

INSTALLATION

1. Mount the ISS-102 in a non-hazardous location by installing two #6 or #8 screws into the surface mounting holes provided.
2. Connect wiring per SymCom's Control Drawing ISS-102CCI-M on page 4. Follow all hazardous code requirements while installing wiring to switch input terminals.

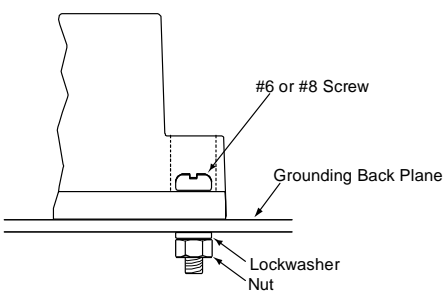

Figure 1: Connection to Ground Plane

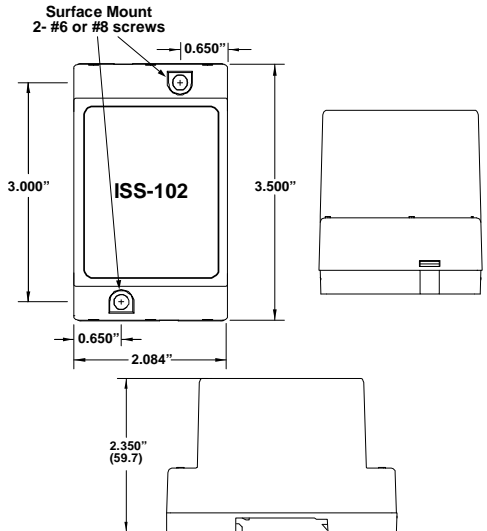

Figure 2: Dimensions

II-ISS-102CCI-MC-B

**DO NOT CHANGE WITHOUT
APPROVAL FROM MSHA**

OPERATION

The ISS-102CCI-M-MC (Multi-function Controller) is user-configurable as a single or dual-channel switch, or pump-up/pump-down controller. The intrinsically-safe inputs are compatible with normally open (N.O.) or normally closed (N.C.) switches, as well as resistive probes. **NOTE: Prior to installation, set the DIP switches according to your specific system configuration (refer to Table 1).**

DIP SWITCH*	DESCRIPTION	SWITCH POSITION (ON = ↑, OFF = ↓)
S1, S2	MODE SELECT	OFF, OFF = Differential/Latching Logic
		ON, OFF = 1-Channel Switch
		OFF, ON = 2-Channel Switch
S3	LOGIC	OFF = Direct Logic
		ON = Inverted Logic
S4	DEBOUNCE	OFF = .5 second
		ON = 2 seconds

*S1, S2, S3, and S4 refer to the DIP switches on the side of the ISS-102.

TABLE 1: Setting the DIP Switches

Definitions

Normally Open (N.O.) – switch is “open” when water is **not** present

Normally Closed (N.C.) – switch is “closed” when water is **not** present

Direct Logic – input channels are active when “low” resistance (or closed switch) is detected

Inverted Logic – input channels are active when “high” resistance (or open switch) is detected

Debounce – the time delay required between changes of state (prevents nuisance tripping)

Sensitivity – resistance level required to change the state of the input channels

NOTE: if using resistive probes, set the sensitivity to the desired resistance limit, 4.7–100kΩ. If using switches, set the sensitivity to 100kΩ.

LED1 and LED2 – Each LED illuminates when its corresponding output relay is energized

Single-Channel Switch Mode

In single-channel switch mode, RELAY 1 (form A) and RELAY 2 (form C) will energize when **CH1** is activated (CH2 is disabled in this mode). Refer to Table 2 for proper DIP switch configuration.

FUNCTION	S1	S2	S3
1-Channel Switch with Direct Logic	ON	OFF	OFF
1-Channel Switch with Inverted Logic	ON	OFF	ON

TABLE 2: Single-Channel Mode

Dual-Channel Switch (non-latching)

In dual-channel mode, RELAY 1 (form A) will energize when **CH1** is activated, and RELAY 2 (form C) will energize when **CH2** is activated. Refer to Table 3 for proper DIP switch configuration.

FUNCTION	S1	S2	S3
2-Channel Switch with Direct Logic	OFF	ON	OFF
2-Channel Switch with Inverted Logic	OFF	ON	ON

TABLE 3: Dual-Channel Mode

Dual-Channel Differential / Latching Mode

Normally-Open (N.O.) Switches or Resistive Probes:

Pump-Down: Connect the **lower** float/probe to **CH1** (lead) and the **upper** float/probe to **CH2** (lag). Once the water level in the tank rises enough to activate the lag input, both output relays will energize and turn on the pump. After enough water is pumped from the tank to deactivate the lead input, the relays will de-energize and turn off the pump. Refer to Table 4 for proper DIP switch configuration.

FUNCTION	S1	S2	S3
Pump-Down with N.O. Switches or Resistive Probes (see Examples 1 & 2)	OFF	OFF	OFF

TABLE 4: Dual-Channel Latching Mode

Pump-Up: Connect the **upper** float/probe to **CH1** (lead) and the **lower** float/probe to **CH2** (lag). Once the water level in the tank drops enough to activate the lag input, both output relays will energize and turn on the pump. After enough water is pumped into the tank to deactivate the lead input, the relays will de-energize and turn off the pump. Refer to Table 5 for proper switch configuration.

FUNCTION	S1	S2	S3
Pump-Up with N.O. Switches or Resistive Probes (see Examples 3 & 4)	OFF	OFF	ON

2 TABLE 5: Dual-Channel Latching Mode

Dual-Channel Differential / Latching Mode (cont.)

Normally-Closed (N.C.) Switches:

Pump-Down: Connect the **lower** float to **CH1** (lead) and the **upper** float/probe to **CH2** (lag). Once the water level in the tank rises enough to activate the lag input, both output relays will energize and turn on the pump. After enough water is pumped from the tank to deactivate the lead input, the relays will de-energize and turn off the pump. Refer to Table 6 for proper DIP switch configuration.

FUNCTION	S1	S2	S3
Pump-Down with N.C. Switches (see Example 5)	OFF	OFF	ON

TABLE 6: Dual-Channel Latching Mode

Pump-Up: Connect the **upper** float to **CH1** (lead) and the **lower** float/probe to **CH2** (lag). Once the water level in the tank drops enough to activate the lag input, both output relays will energize and turn on the pump. After enough water is pumped into the tank to deactivate the lead input, the relays will de-energize and turn off the pump. Refer to Table 7 for proper DIP switch configuration.

FUNCTION	S1	S2	S3
Pump-Up with N.C. Switches (see Example 6)	OFF	OFF	OFF

TABLE 7: Dual-Channel Latching Mode

EXAMPLE WIRING DIAGRAMS (examples apply to Differential / Latching Mode only)

EXAMPLE 1:
Pump-Down with
N.O. Switches

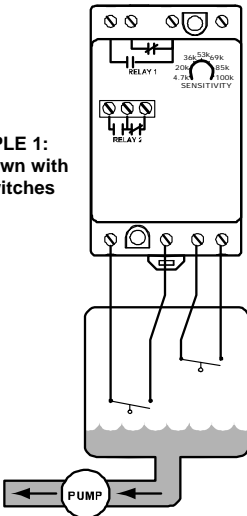

EXAMPLE 2:
Pump-Down with
Probes

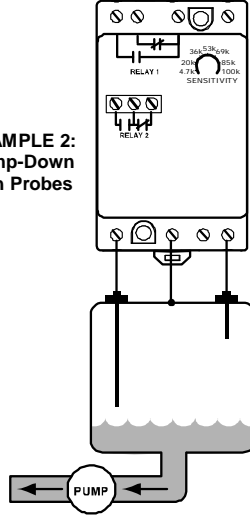

EXAMPLE 3:
Pump-Up with
N.O. Switches

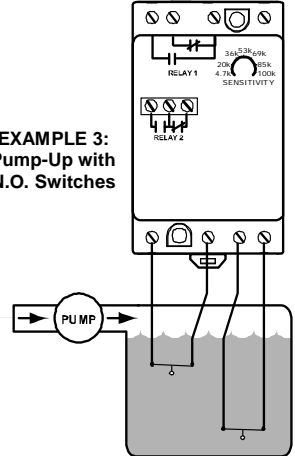

EXAMPLE 4:
Pump-Up with
Probes

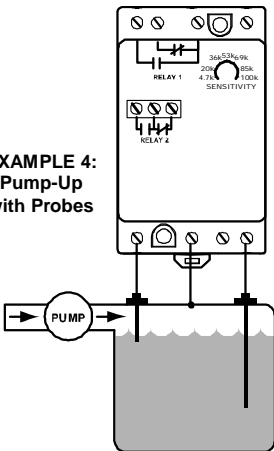

EXAMPLE 5:
Pump-Down with
N.C. Switches

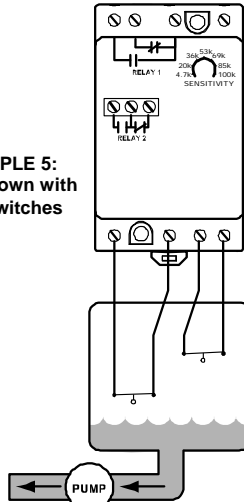

EXAMPLE 6:
Pump-Up with
N.C. Switches

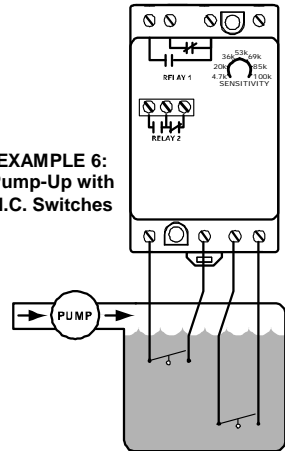

CONTROL DRAWING ISS-102CCI-M

ASSOCIATED APPARATUS / APPAREILLAGE CONNEXE

Revision A

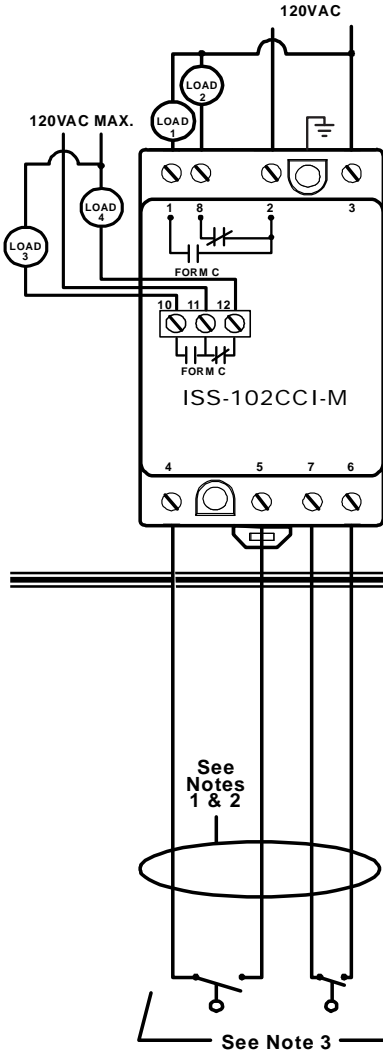

Non-Hazardous Location

Supply Voltage

120VAC

Relay Output Rating

5 Amps @ 120VAC General Purpose
Pilot Duty 180VA @ 120VAC, C150

Maximum Ambient Temperature Rating

55°C

DEVICE MUST BE INSTALLED IN A SUITABLE ENCLOSURE

WARNING!

TO PREVENT IGNITION OF FLAMMABLE OR COMBUSTIBLE ATMOSPHERES, DISCONNECT POWER BEFORE SERVICING.

DEVICE MAY ONLY BE REPAIRED BY THE MANUFACTURER

WARNING!

SUBSTITUTION OF COMPONENTS MAY IMPAIR INTRINSIC SAFETY.

AVERTISSEMENT!

LA SUBSTITUTION DE COMPOSANTS PEUT COMPROMETTRE LA SÉCURITÉ INTRINSÈQUE.

Hazardous Location

Class I, Divisions I & II, Groups A, B, C & D;
Class II, Divisions I & II, Groups E, F & G; and
Class III locations

NOTES:

- Maximum distance between unit and switch contact is 10,000 feet.
- All non-intrinsically safe wiring shall be separated from intrinsically safe wiring. Description of special wiring methods can be found in the National Electrical Code ANSI/NFPA 70, Article 504 Intrinsically Safe Systems. Check your state and local codes for additional requirements.
- All switch contacts shall be non-energy storing, containing no inductance or capacitance.
- Entity Parameters:
 $V_{oc} = 16.8V$ $C_a = 0.39\mu F$
 $I_{sc} = 1.2mA$ $P_o = \frac{V_{oc} \cdot I_{sc}}{4}$
 $L_a = 100mH$

5. Entity Parameter Relationships:

<u>IS Equipment</u>	<u>Associated Apparatus</u>
V_{max} (or U_i)	$\geq V_{oc}$ or V_t (or U_o)
I_{max} (or I_i)	$\geq I_{sc}$ or I_t (or I_o)
P_{max} , P_i	$\geq P_o$
$C_i + C_{cable}$	$\leq C_a$ (or C_o)
$L_i + L_{cable}$	$\leq L_a$ (or L_o)

Capacitance and inductance of the field wiring from the intrinsically-safe equipment to the associated apparatus shall be calculated and must be included in the system calculations as shown in the table above. Cable capacitance, C_{cable} , plus intrinsically-safe equipment capacitance, C_i , must be less than the marked capacitance, C_a (or C_o), shown on any associated apparatus used. The same applies for inductance (L_{cable} , L_i and L_a or L_o , respectively). Where the cable capacitance and inductance per foot are not known, the following values shall be used: $C_{cable} = 60pF/ft.$, $L_{cable} = 0.2\mu H/ft.$

DO NOT CHANGE WITHOUT APPROVAL FROM MSHA