

QJxx40xx Series

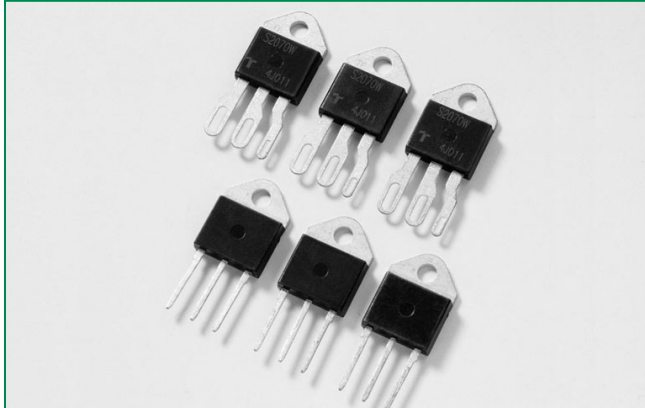

Description

The 40 Amp bi-directional solid state switch series is designed for AC switching and phase control applications such as motor speed, temperature modulation controls, lighting controls, and static switching relays.

Alternistor type components only operate in quadrants I, II, & III and are used in circuits requiring high dv/dt capability.

Standard type devices operate in quadrants I,II,III & IV.

Agency Recognitions

Agency	Agency File Number
	E71639*

* - K and J Packages

Features & Benefits

- RoHS Compliant
- High T_j of 150°C
- Voltage capability up to 800V
- Surge capability up to 500A
- Electrically isolated for 2500Vrms
- UL Recognized to UL 1557 as an Electrically Isolated Semiconductor Device

Main Features

Symbol	Value	Unit
I _{T(RMS)}	40	A
V _{DRM} /V _{RRM}	400 to 800	V
I _{GT (Q1)}	35 to 100	mA

Schematic Symbol

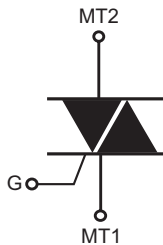

Applications

Excellent for AC switching and phase control applications such as heating, lighting, and motor speed controls.

Typical applications are AC solid-state switches, industrial power tools, exercise equipment, white goods and commercial appliances.

Alternistor Triacs (no snubber required) are used in applications with extremely inductive loads requiring highest commutation performance.

Internally constructed isolated packages are offered for ease of heat sinking with highest isolation voltage.

Absolute Maximum Ratings – Alternistor Triac (3 Quadrants)

Symbol	Parameter			Value	Unit
$I_{T(RMS)}$	RMS on-state current (full sine wave)	QJxx40xH5 QJxx40xH7 QJxx40xH6	$T_c = 100\text{ }^\circ\text{C}$	40	A
I_{TSM}	Non repetitive surge peak on-state current (full cycle, T_J initial = $25\text{ }^\circ\text{C}$)	$f = 50\text{ Hz}$	$t = 20\text{ ms}$	420	A
		$f = 60\text{ Hz}$	$t = 16.7\text{ ms}$	500	
I^2t	I ² t Value for fusing		$t_p = 8.3\text{ ms}$	1037	A ² s
di/dt	Critical rate of rise of on-state current ($I_G = 2 \times I_{GT}$, $t_r \leq 100\text{ ns}$)	$f = 120\text{ Hz}$	$T_J = 150\text{ }^\circ\text{C}$	150	A/ μs
I_{GTM}	Peak gate trigger current	$t_p = 20\text{ }\mu\text{s}$	$T_J = 150\text{ }^\circ\text{C}$	4	A
$P_{G(AV)}$	Average gate power dissipation		$T_J = 150\text{ }^\circ\text{C}$	0.5	W
T_{stg}	Storage temperature range			-40 to 150	$^\circ\text{C}$
T_J	Operating junction temperature range			-40 to 150	$^\circ\text{C}$
V_{DSM}/V_{RSM}	Peak non-repetitive blocking voltage		400-600V	$V_{DRM}/\sqrt{V_{RRM}} + 100$	V
			800V	$V_{DRM}/\sqrt{V_{RRM}} + 200$	

Absolute Maximum Ratings – Standard Triac (4 Quadrants)

Symbol	Parameter	Test Conditions		Value	Unit
$I_{T(RMS)}$	RMS on-state current	QJxx40x3 QJxx40x4	$T_c = 100\text{ }^\circ\text{C}$	40	A
I_{TSM}	Peak non-repetitive surge current	$f = 50\text{ Hz}$	$t = 20\text{ ms}$	420	A
		$f = 60\text{ Hz}$	$t = 16\text{ ms}$	500	
I^2t	I ² t Value for fusing		$t_p = 8.3\text{ ms}$	1037	A ² s
di/dt	Critical rate-of-rise of on-state current	$f = 120\text{ Hz}; T_J = 150\text{ }^\circ\text{C}$		150	A/ μs
I_{GTM}	Peak gate current	$t_p = 20\text{ }\mu\text{s}$	$T_J = 150\text{ }^\circ\text{C}$	4	A
$P_{G(AV)}$	Average gate power dissipation	$T_J = 150\text{ }^\circ\text{C}$		0.5	W
T_{stg}	Storage temperature range			-40 to 150	$^\circ\text{C}$
T_J	Operating junction temperature range			-40 to 150	$^\circ\text{C}$

Electrical Characteristics ($T_J = 25^\circ\text{C}$, unless otherwise specified) — Alternistor Triac (3 Quadrants)

Symbol	Test Conditions	Quadrant		Value			Unit
				QJxx40xH6	QJxx40xH5	QJxx40xH7	
I_{GT}	$V_D = 12\text{V}$ $R_L = 60\ \Omega$	I – II – III	MAX.	80	50	100	mA
V_{GT}	$V_D = 12\text{V}$ $R_L = 60\ \Omega$	I – II – III	MAX.	1.3	1.3	1.3	V
V_{GD}	$V_D = V_{DRM}$ $R_L = 3.3\ \text{k}\Omega$ $T_J = 150^\circ\text{C}$	I – II – III	MIN.	0.2			V
I_H	$I_T = 400\text{mA}$		MAX.	80	75	100	mA
dv/dt	$V_D = V_{DRM}$ Gate Open $T_J = 150^\circ\text{C}$	400V	MIN.	1800	1300	2500	V/ μs
		600V		1600	1200	2200	
		800V		1500	1000	2000	
(dv/dt)c	(di/dt)c = 21.6 A/ms $T_J = 150^\circ\text{C}$		MIN.	30	20	40	V/ μs
t_{gt}	$I_G = 2 \times I_{GT}$ $PW = 15\ \mu\text{s}$ $I_T = 56.6\text{A(pk)}$		TYP.	5			μs

Electrical Characteristics ($T_J = 25^\circ\text{C}$, unless otherwise specified) — Standard Triac (4 Quadrants)

Symbol	Test Conditions	Quadrant		Value		Unit
				QJxx40x3	QJxx40x4	
I_{GT}	$V_D = 12\text{V}$; $R_L = 60\ \Omega$	I – II – III	MAX.	35	50	mA
		IV	MAX.	70	100	
V_{GT}	$V_D = 12\text{V}$; $R_L = 60\ \Omega$	ALL	MAX.	1.3		V
V_{GD}	$V_D = V_{DRM}$; $R_L = 3.3\ \text{k}\Omega$; $T_J = 150^\circ\text{C}$	ALL	MIN.	0.2		V
I_H	$I_T = 400\text{mA}$ (initial)		MAX.	60	80	mA
dv/dt	$V_D = V_{DRM}$; Gate Open; $T_J = 150^\circ\text{C}$	400V	MIN.	800	1500	V/ μs
		600V		600	1200	
		800V		500	1000	
(dv/dt)c	(di/dt)c = 4.3 A/ms; $T_J = 150^\circ\text{C}$		MIN.	10		V/ μs
t_{gt}	$I_G = 2 \times I_{GT}$; $PW = 15\ \mu\text{s}$; $I_T = 35.4\ \text{A}$		TYP.	5		μs

Static Characteristics

Symbol	Test Conditions			Value	Unit	
V_{TM}	$I_{TM} = 56.6\text{A}$ $t_p = 380\ \mu\text{s}$	$T_J = 25^\circ\text{C}$	MAX.	1.6	V	
I_{DRM} I_{RRM}	$V_D = V_{DRM} / V_{RRM}$	$T_J = 25^\circ\text{C}$	400 – 800V	MAX.	20	μA
		$T_J = 125^\circ\text{C}$	400 – 800V	MAX.	2	mA
		$T_J = 150^\circ\text{C}$	800V	MAX.	6	mA

Thermal Resistances

Symbol	Parameter	Value	Unit	
$R_{\theta(JC)}$	Junction to case (AC)	QJxx40KH6 QJxx40KH5/H7 QJxx40K3 QJxx40K4/J4	1.6	°C/W
		QJxx40JH6 QJxx40JH7	1.5	

Note: xx = voltage

Figure 1: Definition of Quadrants

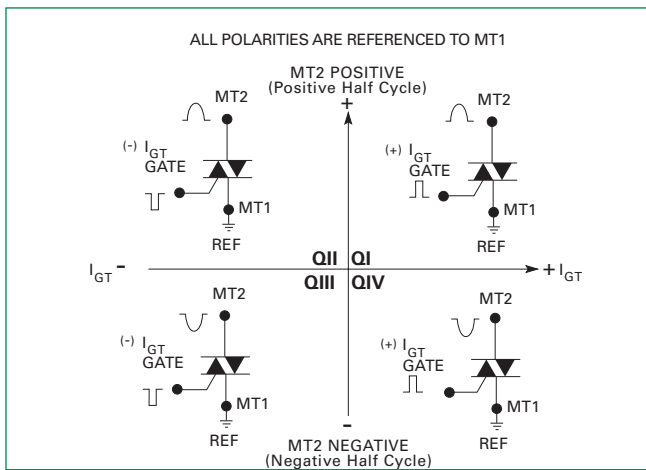

Note: Alternistors will not operate in QIV

Figure 2: Normalized DC Gate Trigger Current for All Quadrants vs. Junction Temperature

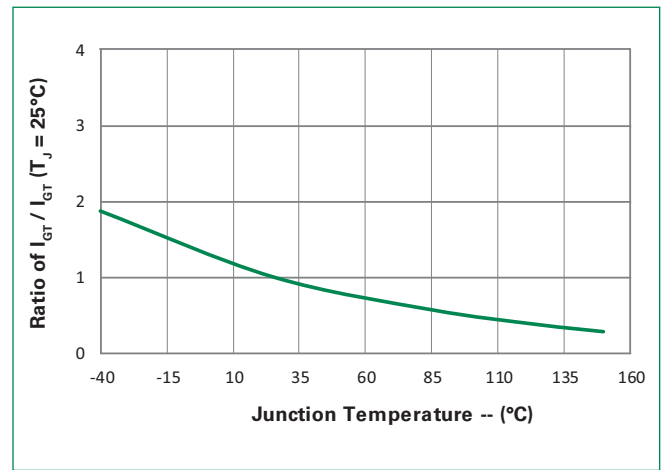

Figure 3: Normalized DC Holding Current vs. Junction Temperature

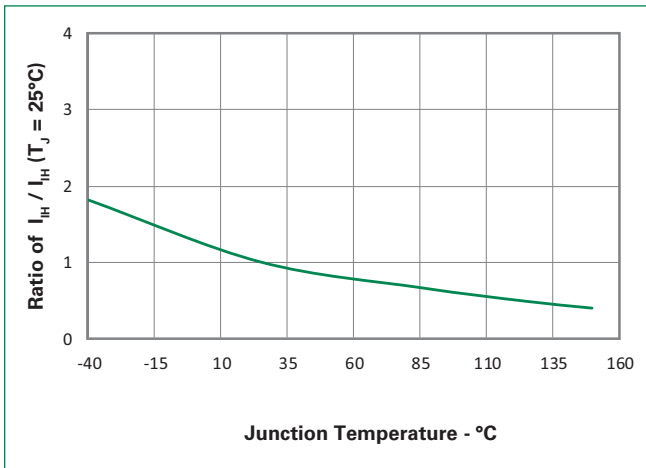

Figure 4: Normalized DC Gate Trigger Voltage for All Quadrants vs. Junction Temperature

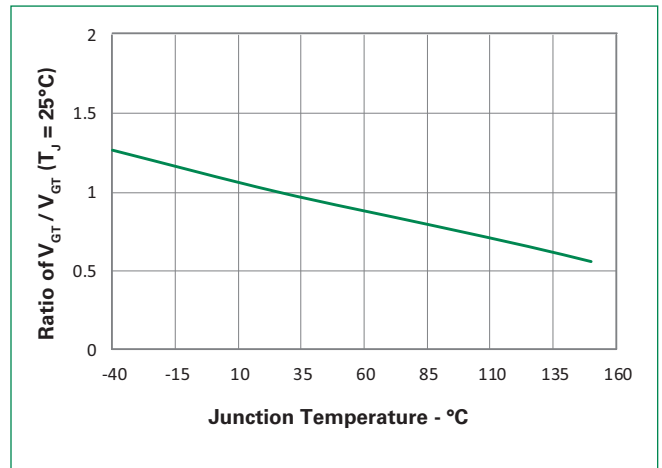

Figure 5: Power Dissipation (Typical) vs. RMS On-State Current

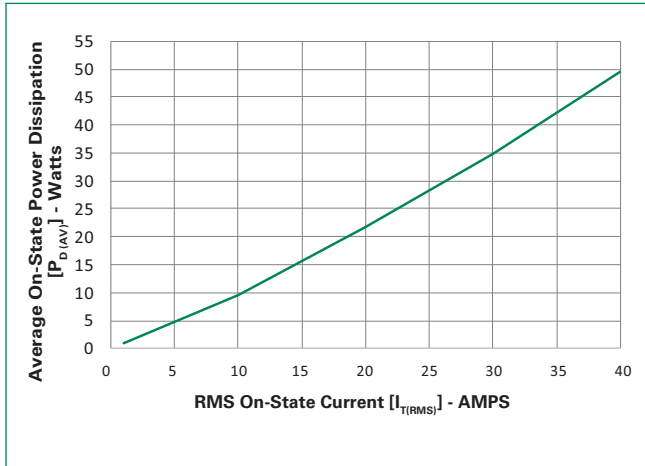

Figure 6: Maximum Allowable Case Temperature vs. On-State Current

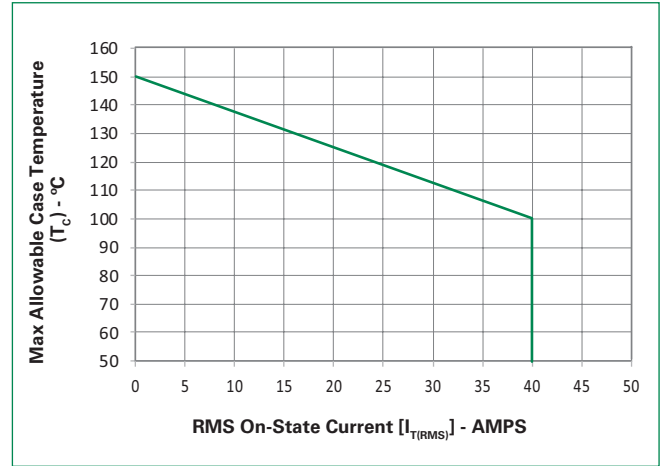

Figure 7: On-State Current vs. On-State Voltage (Typical)

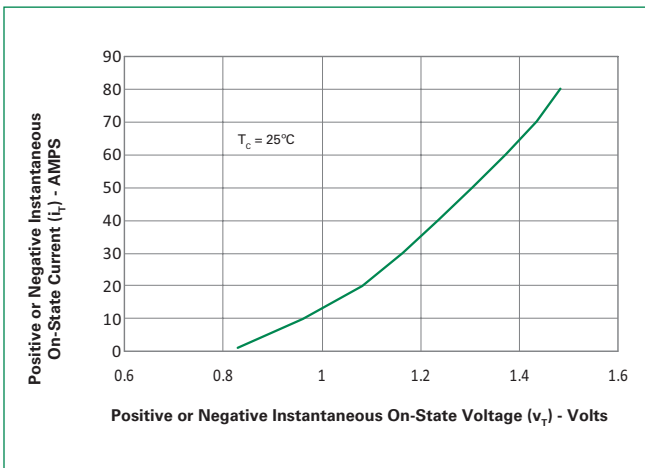
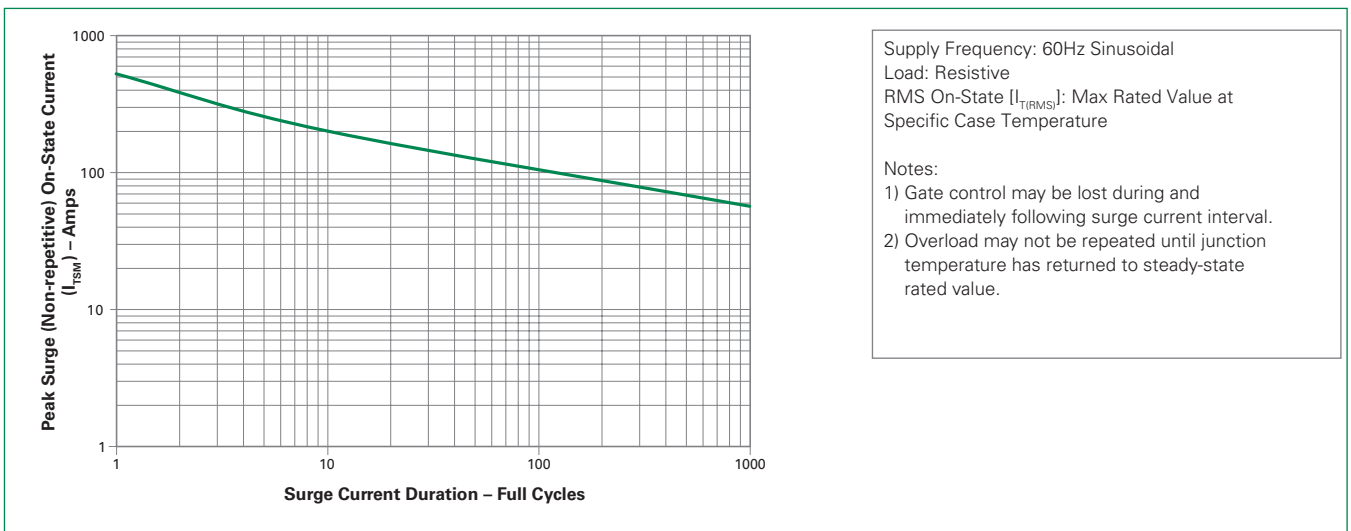

Figure 8: Surge Peak On-State Current vs. Number of Cycles



Supply Frequency: 60Hz Sinusoidal
 Load: Resistive
 RMS On-State [I_{T(RMS)}]: Max Rated Value at Specific Case Temperature

- Notes:
- 1) Gate control may be lost during and immediately following surge current interval.
 - 2) Overload may not be repeated until junction temperature has returned to steady-state rated value.

Soldering Parameters

Reflow Condition		Pb – Free assembly
Pre Heat	- Temperature Min ($T_{s(min)}$)	150°C
	- Temperature Max ($T_{s(max)}$)	200°C
	- Time (min to max) (t_s)	60 – 180 secs
Average ramp up rate (Liquidus Temp (T_L) to peak)		5°C/second max
$T_{s(max)}$ to T_L - Ramp-up Rate		5°C/second max
Reflow	- Temperature (T_L) (Liquidus)	217°C
	- Time (min to max) (t_s)	60 – 150 seconds
Peak Temperature (T_p)		260 ^{+0/-5} °C
Time within 5°C of actual peak Temperature (t_p)		20 – 40 seconds
Ramp-down Rate		5°C/second max
Time 25°C to peak Temperature (T_p)		8 minutes Max.
Do not exceed		280°C

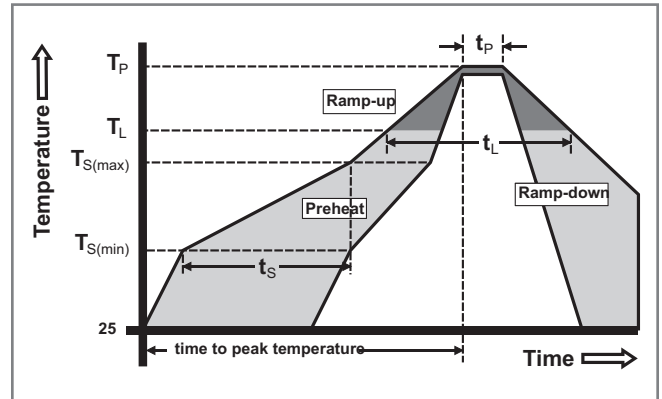

Physical Specifications

Terminal Finish	100% Matte Tin-plated.
Body Material	UL Recognized compound meeting flammability rating V-0.
Lead Material	Copper Alloy

Design Considerations

Careful selection of the correct component for the application's operating parameters and environment will go a long way toward extending the operating life of the Thyristor. Good design practice should limit the maximum continuous current through the main terminals to 75% of the component rating. Other ways to ensure long life for a power discrete semiconductor are proper heat sinking and selection of voltage ratings for worst case conditions. Overheating, overvoltage (including dv/dt), and surge currents are the main killers of semiconductors. Correct mounting, soldering, and forming of the leads also help protect against component damage.

Environmental Specifications

Test	Specifications and Conditions
AC Blocking	MIL-STD-750, M-1040, Cond A Applied Peak AC voltage @ 125°C for 1008 hours
Temperature Cycling	MIL-STD-750, M-1051, 100 cycles; -40°C to +150°C; 15-min dwell-time
Temperature/Humidity	EIA / JEDEC, JESD22-A101 1008 hours; 320V - DC: 85°C; 85% rel humidity
High Temp Storage	MIL-STD-750, M-1031, 1008 hours; 150°C
Low-Temp Storage	1008 hours; -40°C
Resistance to Solder Heat	MIL-STD-750 Method 2031
Solderability	ANSI/J-STD-002, category 3, Test A
Lead Bend	MIL-STD-750, M-2036 Cond E

Dimensions — TO-218X (J Package) — Isolated Mounting Tab

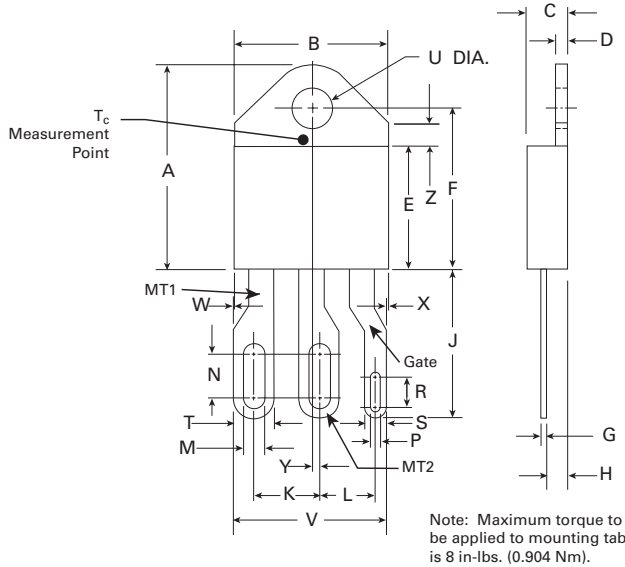

Dimension	Inches		Millimeters	
	Min	Max	Min	Max
A	0.810	0.835	20.57	21.21
B	0.610	0.630	15.49	16.00
C	0.178	0.188	4.52	4.78
D	0.055	0.070	1.40	1.78
E	0.487	0.497	12.37	12.62
F	0.635	0.655	16.13	16.64
G	0.022	0.029	0.56	0.74
H	0.075	0.095	1.91	2.41
J	0.575	0.625	14.61	15.88
K	0.256	0.264	6.50	6.71
L	0.220	0.228	5.58	5.79
M	0.080	0.088	2.03	2.24
N	0.169	0.177	4.29	4.49
P	0.034	0.042	0.86	1.07
R	0.113	0.121	2.87	3.07
S	0.086	0.096	2.18	2.44
T	0.156	0.166	3.96	4.22
U	0.161	0.165	4.10	4.20
V	0.603	0.618	15.31	15.70
W	0.000	0.005	0.00	0.13
X	0.003	0.012	0.07	0.30
Y	0.028	0.032	0.71	0.81
Z	0.085	0.095	2.17	2.42

Dimensions — TO-218AC (K Package) — Isolated Mounting Tab

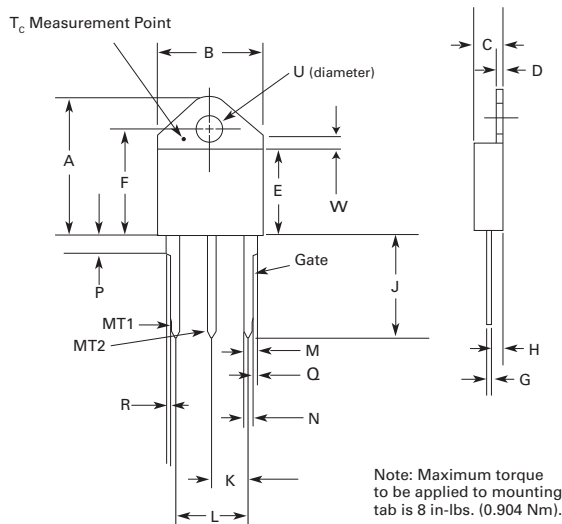

Dimension	Inches		Millimeters	
	Min	Max	Min	Max
A	0.810	0.835	20.57	21.21
B	0.610	0.630	15.49	16.00
C	0.178	0.188	4.52	4.78
D	0.055	0.070	1.40	1.78
E	0.487	0.497	12.37	12.62
F	0.635	0.655	16.13	16.64
G	0.022	0.029	0.56	0.74
H	0.075	0.095	1.91	2.41
J	0.575	0.625	14.61	15.88
K	0.211	0.219	5.36	5.56
L	0.422	0.437	10.72	11.10
M	0.058	0.068	1.47	1.73
N	0.045	0.055	1.14	1.40
P	0.095	0.115	2.41	2.92
Q	0.008	0.016	0.20	0.41
R	0.008	0.016	0.20	0.41
U	0.161	0.165	4.10	4.20
W	0.085	0.095	2.17	2.42

Product Selector

Part Number	Voltage			Gate Sensitivity Quadrants		I _{T(RMS)}	Type	Package
	400V	600V	800V	I – II – III	IV			
QJxx40KH6	X	X	X	80 mA		40 A	Alternistor Triac	TO-218AC
QJxx40JH6	X	X	X	80 mA		40 A	Alternistor Triac	TO-218X
QJxx40KH5	X	X	X	50 mA		40 A	Alternistor Triac	TO-218AC
QJxx40KH7	X	X	X	100 mA		40 A	Alternistor Triac	TO-218AC
QJxx40JH7	X	X	X	100 mA		40 A	Alternistor Triac	TO-218X
QJxx40K3	X	X	X	35 mA	70 mA	40 A	Standard Triac	TO-218AC
QJxx40K4	X	X	X	50 mA	100 mA	40 A	Standard Triac	TO-218AC

Note: xx = Voltage

Packing Options

Part Number	Marking	Weight	Packing Mode	Base Quantity
QJxx40KH6TP	QJxx40KH6	4.40 g	Tube Pack	250 (25 per tube)
QJxx40JH6TP	QJxx40JH6	5.23 g	Tube Pack	250 (25 per tube)
QJxx40KH5TP	QJxx40KH5	4.40 g	Tube Pack	250 (25 per tube)
QJxx40KH7TP	QJxx40KH7	4.40 g	Tube Pack	250 (25 per tube)
QJxx40JH7TP	QJxx40JH7	5.23 g	Tube Pack	250 (25 per tube)
QJxx40K3TP	QJxx40K3	4.40 g	Tube Pack	250 (25 per tube)
QJxx40K4TP	QJxx40K4	4.40 g	Tube Pack	250 (25 per tube)

Note: xx = Voltage

Part Numbering System

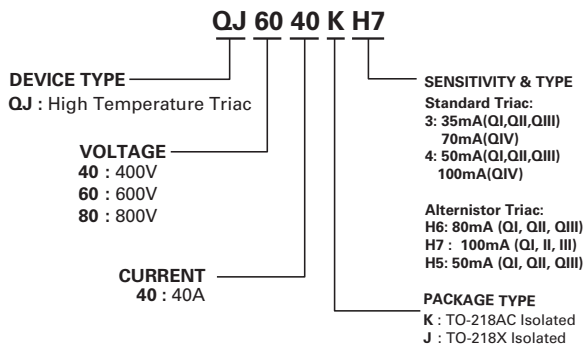

Part Marking System

TO-218 AC - (K Package)
TO-218 X - (J Package)

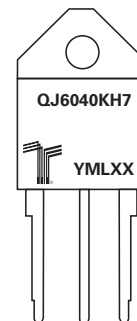

Disclaimer Notice - Information furnished is believed to be accurate and reliable. However, users should independently evaluate the suitability of and test each product selected for their own applications. Littelfuse products are not designed for, and may not be used in, all applications. Read complete Disclaimer Notice at <http://www.littelfuse.com/disclaimer-electronics>.