

SP0502B Series 1pF 15kV Diode Arrays



Description

The SP0502B is a low capacitance TVS diode array designed to protect high-speed data interfaces from over-voltage caused by ESD (electrostatic discharge), CDE (Cable Discharge Events), and EFT (electrical fast transients). It has a typical capacitance of only 0.3pF (pin 1 to 2) making it suitable for use on circuits operating in excess of 3GHz without signal attenuation.

The SP0502BXTG is in a small SOT-523 package and each device can be configured to protect 1 bidirectional line or two unidirectional lines. The combination of small size, ultra-low capacitance, and high level of ESD protection makes it an ideal solution for applications such as HDMI, USB, MDDI, antennas, and DisplayPort.

Functional Block Diagram and Pinout

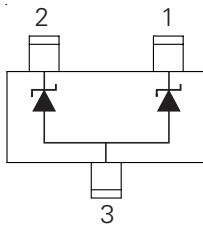

Life Support Note:

Not Intended for Use in Life Support or Life Saving Applications

The products shown herein are not designed for use in life sustaining or life saving applications unless otherwise expressly indicated.

Features

- RoHS compliant and lead-free
- ESD protection of $\pm 15\text{kV}$ contact discharge, $\pm 20\text{kV}$ air discharge, (IEC 61000-4-2)
- EFT, IEC 61000-4-4, 40A (5/50ns)
- Lightning protection, IEC 61000-4-5 2nd edition, 2A ($t_p = 8/20\mu\text{s}$)
- Stand-off voltage of 5V
- Low capacitance of 1pF @ $V_R = 0\text{V}$ (MAX)
- Low leakage current of 0.5 μA at 5V (MAX)
- Small form factor (SOT523) and low profile (<1mm)
- No insertion loss to >3.0GHz

Additional Information



Datasheet



Resources



Samples

Applications

- High-Definition Multimedia Interface (HDMI)
- Mobile Display Digital Interface (MDDI)
- RF/Antenna Circuits
- USB 2.0
- DisplayPort
- Mobile - Smartphone, Tablet, Notebook

Absolute Maximum Ratings

| Symbol | Parameter | Value | Units |
|------------|--|------------|-------|
| P_{PK} | Peak Pulse Power ($t_p=8/20\mu s$) | 25 | W |
| I_{PP} | Peak Pulse Current ($t_p=8/20\mu s$) | 2 | A |
| T_{OP} | Operating Temperature | -40 to 125 | °C |
| T_{STOR} | Storage Temperature | -55 to 150 | °C |

CAUTION: Stresses above those listed in "Absolute Maximum Ratings" may cause permanent damage to the device. This is a stress only rating and operation of the device at these or any other conditions above those indicated in the operational sections of this specification is not implied.

Thermal Information

| Parameter | Rating | Units |
|---|------------|-------|
| Storage Temperature Range | -55 to 150 | °C |
| Maximum Junction Temperature | 150 | °C |
| Maximum Lead Temperature (Soldering 20-40s) | 260 | °C |

Electrical Characteristics ($T_{OP} = 25^\circ C$)

| Parameter | Symbol | Test Conditions | Min | Typ | Max | Units |
|------------------------------------|---------------|---|----------|------|-----|----------|
| Reverse Standoff Voltage | V_{RWM} | $I_R \leq 1\mu A$, Pin1 or Pin2 to Pin3 and Pin1 to Pin2 | | | 5.0 | V |
| Reverse Breakdown Voltage | V_{BR} | $I_t = 1mA$, Pin1 or Pin2 to Pin3 | 6 | | | V |
| Leakage Current | I_{LEAK} | $V_R = 5V$ | | | 0.5 | μA |
| Clamp Voltage ¹ | V_C | $I_{PP} = 1A$, $t_p = 8/20\mu s$, Pin 1 to Pin 2 | | | 12 | V |
| Dynamic Resistance ² | R_{DYN} | TLP, $t_p = 100ns$, I/O to GND | | 0.45 | | Ω |
| ESD Withstand Voltage ¹ | V_{ESD} | IEC 61000-4-2 (Contact Discharge) | ± 15 | | | kV |
| | | IEC 61000-4-2 (Air Discharge) | ± 20 | | | kV |
| Diode Capacitance ¹ | $C_{I/O-I/O}$ | Reverse Bias=0V, $f=1MHz$; Pin 1 to Pin2 | | 0.25 | 0.5 | pF |
| | $C_{I/O-GND}$ | Reverse Bias=0V, $f=1MHz$; Pin 1 or Pin2 to Pin 3 | | | 1.0 | pF |

Note:

1 Parameter is guaranteed by design and/or device characterization.

2 Transmission Line Pulse (TLP) with 100ns width and 200ps rise time.

Pulse Waveform

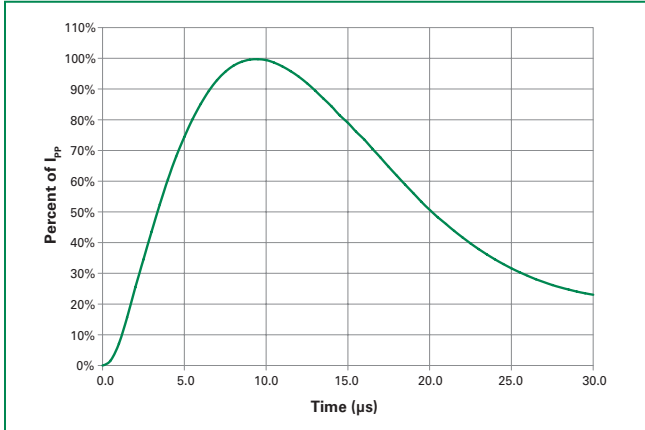

Insertion Loss of Pin 1 to Pin 2 (I/O to I/O)

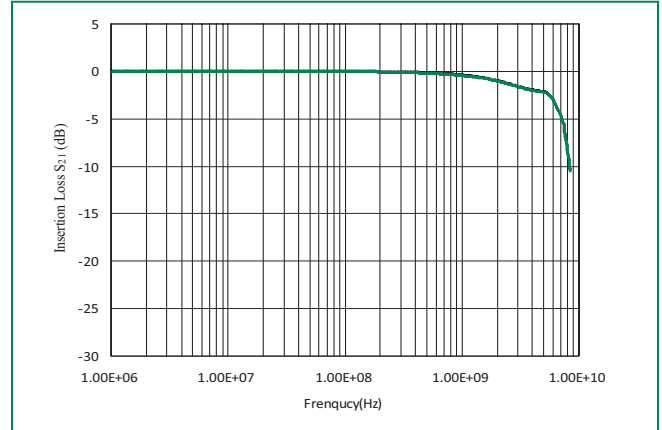

Capacitance vs. Reverse Bias (Pin 1 or Pin 2 to Pin 3)

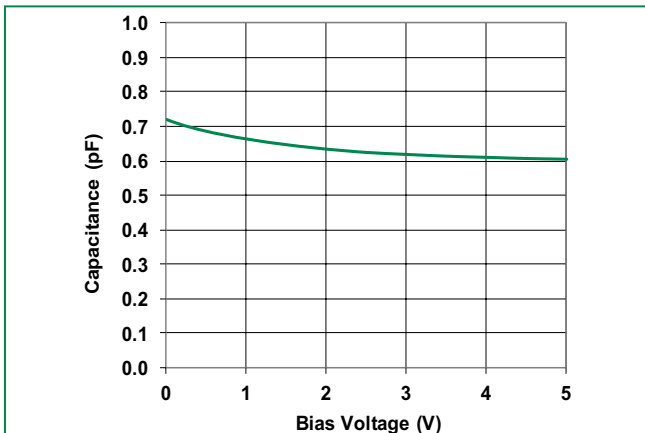

Capacitance vs. Reverse Bias (I/O-I/O) (Pin 1 to Pin 2)

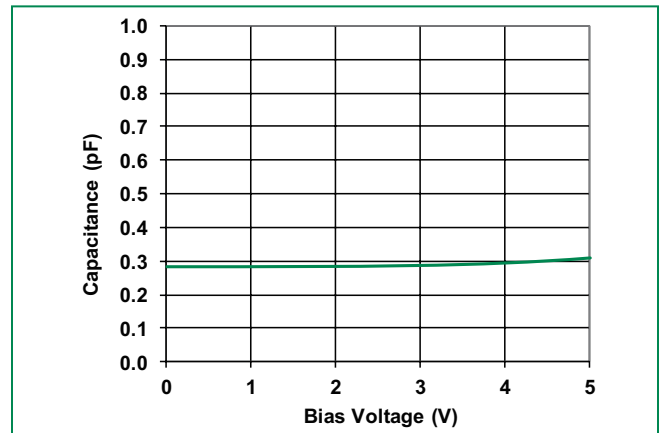

Transmission Line Pulse (TLP)

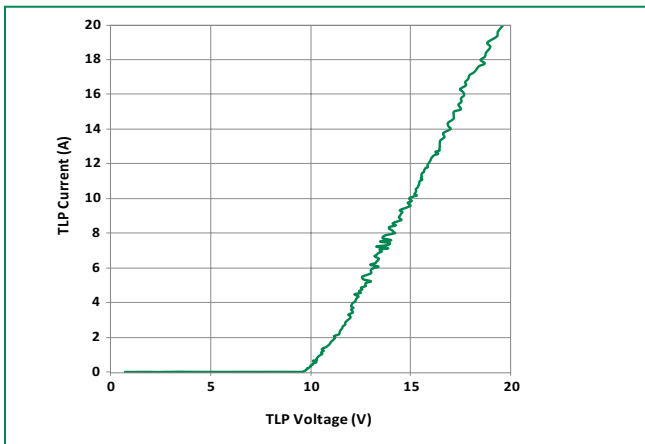

Product Characteristics

| | |
|---------------------------|-------------------------|
| Lead Plating | Pre-Plated Frame |
| Lead Material | Copper Alloy |
| Lead Coplanarity | 0.0004 inches (0.102mm) |
| Substrate material | Silicon |
| Body Material | Molded Epoxy |
| Flammability | UL 94 V-0 |

Notes :

1. All dimensions are in millimeters
2. Dimensions include solder plating.
3. Dimensions are exclusive of mold flash & metal burr.
4. Blo is facing up for mold and facing down for trim/form, i.e. reverse trim/form.
5. Package surface matte finish VDI 11-13.

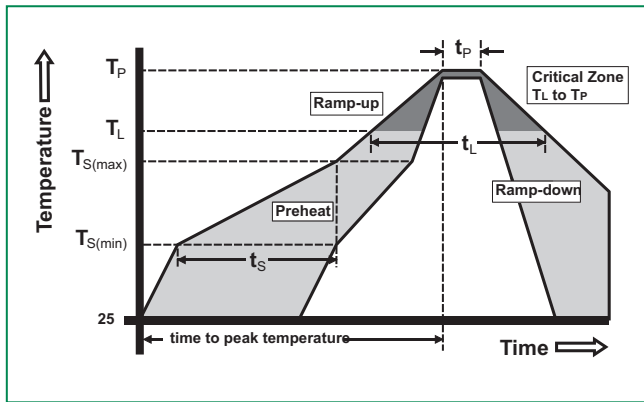

Soldering Parameters

| | | |
|--|------------------------------------|------------------|
| Reflow Condition | Pb – Free assembly | |
| Pre Heat | - Temperature Min ($T_{s(min)}$) | 150°C |
| | - Temperature Max ($T_{s(max)}$) | 200°C |
| | - Time (min to max) (t_s) | 60 – 180 secs |
| Average ramp up rate (Liquidus) Temp (T_L) to peak | 3°C/second max | |
| $T_{S(max)}$ to T_L - Ramp-up Rate | 3°C/second max | |
| Reflow | - Temperature (T_L) (Liquidus) | 217°C |
| | - Temperature (t_L) | 60 – 150 seconds |
| Peak Temperature (T_P) | 260 ^{+0/-5} °C | |
| Time within 5°C of actual peak Temperature (t_p) | 20 – 40 seconds | |
| Ramp-down Rate | 6°C/second max | |
| Time 25°C to peak Temperature (T_P) | 8 minutes Max. | |
| Do not exceed | 260°C | |

Ordering Information

| Part Number | Package | Size | Marking | Min. Order Qty. |
|-------------|---------|-----------|---------|-----------------|
| SP0502BXTG | SOT523 | 1.6x1.6mm | 3** | 3000 |

Part Numbering System

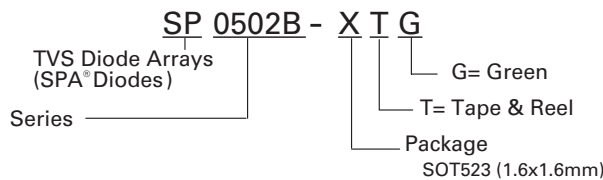

Part Marking System

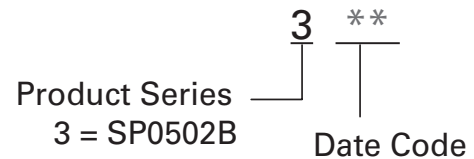

Package Dimensions – SOT523

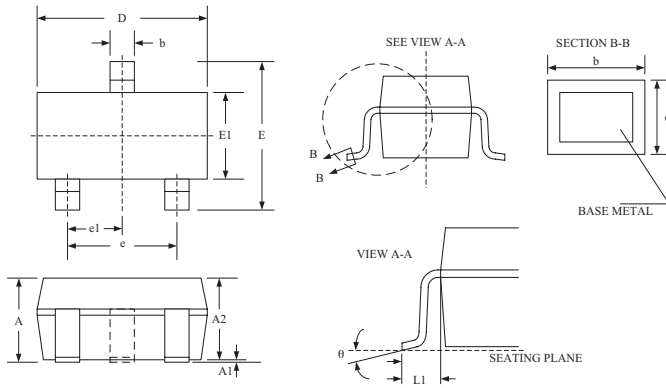

| | Millimetres | | | Inches | | |
|-----------|-------------|------|------|-----------|-------|-------|
| | Min | Typ | Max | Min | Typ | Max |
| A | 0.60 | - | 0.90 | 0.023 | - | 0.035 |
| A1 | 0.00 | - | 0.10 | 0.000 | - | 0.004 |
| A2 | 0.60 | 0.75 | 0.80 | 0.023 | 0.030 | 0.031 |
| b | 0.15 | - | 0.30 | 0.005 | - | 0.012 |
| c | 0.10 | - | 0.20 | 0.003 | - | 0.008 |
| D | 1.50 | 1.60 | 1.70 | 0.059 | 0.063 | 0.067 |
| e | 1.00 BSC | | | 0.039 BSC | | |
| e1 | 0.50 BSC | | | 0.020 BSC | | |
| E | 1.45 | 1.60 | 1.75 | 0.057 | 0.063 | 0.069 |
| E1 | 0.75 | 0.80 | 0.85 | 0.029 | 0.031 | 0.033 |
| L1 | 0.22 REF | | | 0.009 RFE | | |
| θ | 0° | - | 8° | 0° | - | 8° |

Embossed Carrier Tape & Reel Specification – SOT523

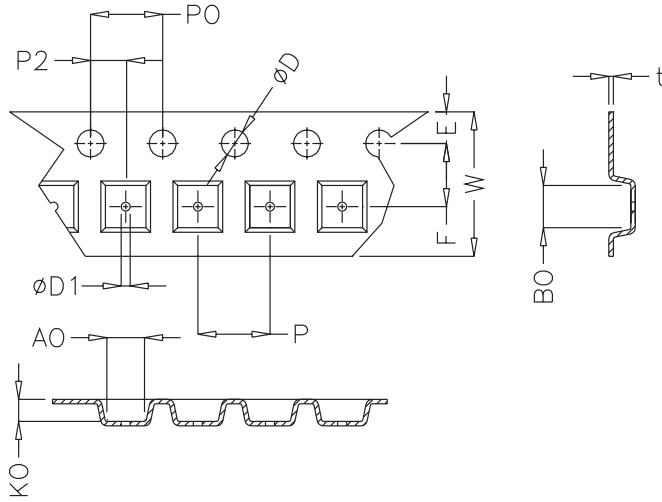

| | Millimetres | | Inches | |
|-------------|--------------|------|---------------|-------|
| | Min | Max | Min | Max |
| E | 1.65 | 1.85 | 0.065 | 0.073 |
| F | 3.45 | 3.55 | 0.135 | 0.139 |
| P2 | 1.95 | 2.05 | 0.077 | 0.081 |
| D | 1.40 | 1.60 | 0.055 | 0.063 |
| D1 | 0.45 | 0.55 | 0.017 | 0.021 |
| P0 | 3.90 | 4.10 | 0.154 | 0.161 |
| 10P0 | 40.0+/- 0.20 | | 1.574+/-0.008 | |
| W | 7.70 | 8.10 | 0.303 | 0.318 |
| P | 3.90 | 4.10 | 0.153 | 0.161 |
| A0 | 1.73 | 1.83 | 0.068 | 0.072 |
| B0 | 1.73 | 1.83 | 0.068 | 0.072 |
| K0 | 0.64 | 0.74 | 0.025 | 0.029 |
| t | 0.22 max | | 0.009 max | |