

59085

Vane Sensor



Description

The 59085 is a reed vane sensor with integral actuator magnet. Its actuation occurs when a suitable low carbon steel vane passes through the slot between the magnet and switch. It is normally open, normally closed, high voltage normally closed or changeover contacts. It is capable of switching up to 265Vac/300Vdc at 10VA. It is ideally suited to position and limit sensing, security, linear actuator, industrial process control and shaft rotation applications.

Features

- Sensor and magnet contained in single housing
- Sensor operates when ferrous vane passes through slot
- Choice of cable length and connector
- RoHS Compliant

Benefits

- Hermetically sealed, magnetically operated contacts continue to operate long after optical and other technologies fail due to contamination
- Quick and reliable single screw mounting with location feature
- No standby power requirement

Agency Approvals

Agency	Agency File Number
	E61760

Note: Contact Littelfuse for specific agency approval ratings.

Applications

- Position and limit sensing
- Security system switch
- Linear actuators
- Industrial process control
- Shaft rotation sensing

Dimensions

Dimensions in mm (inch)

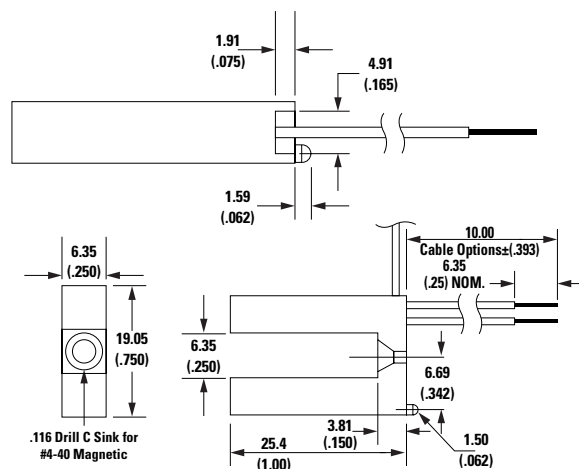

59085

Vane Sensor

Electrical Ratings

	Contact Type		Normally Open	Change Over	Normally Closed	Normally Closed H.V.
Switch Type	-	-	1	3	4	5
Contact Rating ¹	-	VA/Watt - max.	5	5	10	10
Voltage ⁴	Switching ²	Vdc - max.	175	175	200	300
	Breakdown ³	Vac - max.	120	120	140	265
Current ⁴	Switching ²	Vdc - min.	200	200	250	400
		Carry	Adc - max.	0.25	0.25	0.5
	Aac - max.	0.18	0.18	0.35	0.30	
Resistance ⁵	Contact, Initial Insulation	Adc - max.	1.5	1.5	1.2	1.4
		Ω - max.	0.2	0.2	0.2	0.2
		Ω - min.	10 ⁹	10 ⁹	10 ¹⁰	10 ¹⁰
Capacitance	Contact	pF - typ.	0.3	0.3	0.3	0.2
Temperature	Operating	°C	-40 to +105	-40 to +105	-40 to +105	-20 to +105

Product Characteristics



Operate Time ⁶	-	ms - max.	3.0	3.0	1.0	1.0
Release Time ⁶	-	ms - max.	3.0	3.0	1.0	1.0
Shock ⁷	11ms ½ sine	G - max.	50	50	100	100
Vibration ⁷	50-2000 Hz	G - max.	30	30	30	30

Notes:

- Contact rating - Product of the switching voltage and current should never exceed the wattage rating. Contact Littelfuse for additional load/life information.
- When switching inductive and/or capacitive loads, the effects of transient voltages and/or currents should be considered. Refer to Application Notes AN108A and AN107 for details.
- Breakdown Voltage - per MIL-STD-202, Method 301.
- Electrical Load Life Expectancy - Contact Littelfuse with voltage, current values along with type of load.
- This resistance value is for 11.81mm wire length. Resistance changes when wire lengthens.
- Operate (including bounce)/Release Time - per EIA/NARM RS-421-A, diode suppressed coil (Coil II).
- Shock and Vibration - per EIA/NARM RS-421-A and MIL-STD-202.
- For custom modifications to the wire length or size, or adding a special connector, please contact Littelfuse.

Activation

Select Option	Switch Type	Switch Type	
		Activation Distance mm (inch) Average	De-Activation Distance mm (inch) Average
1	Normally Open	1.4 (055)	5.5 (.216)
3	Change Over	1.4 (055)	5.5 (.216)
4	Normally Closed	1.4 (055)	5.5 (.216)
5	High Voltage (Normally Closed)	1.4 (055)	5.5 (.216)

Schematics	Switch Type
 Black Black	1
 Black Blue White	3
 Black Black	4 and 5

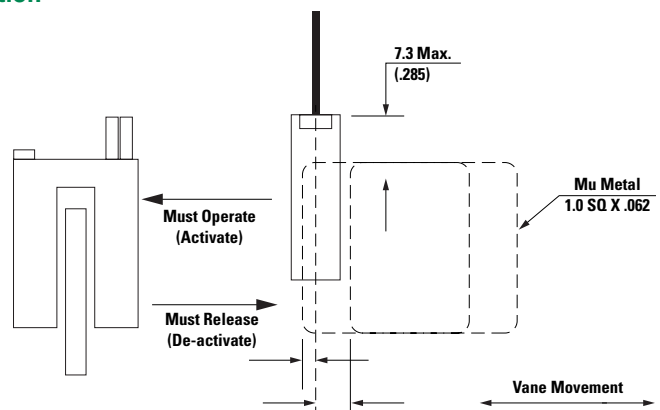

59085

Vane Sensor

Cable Length Specification

Cable Type: 24 AWG 7/32 PVC 105°C UL1430/UL1569	
Select Option	Cable Length mm (inch)
02	300 (11.81)

Termination Specification

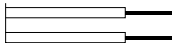
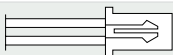
Termination Options		
Select Option	Description (Two-wire versions illustrated)	
A	Tinned leads (6.4±0.76)mm	
F	Untinned leads (6.4±0.76)mm	
E	JST type XHP 2.5mm pitch	

Part Numbering System

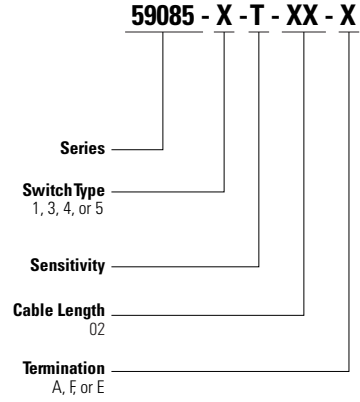

Packaging

Packaging Option	Packaging Specification	Quantity	Quantity & Packaging Code	Taping Width
Bulk	Bulk	500	N/A	N/A

Disclaimer Notice - Information furnished is believed to be accurate and reliable. However, users should independently evaluate the suitability of and test each product selected for their own applications. Littelfuse products are not designed for, and may not be used in, all applications. Read complete Disclaimer Notice at <http://www.littelfuse.com/disclaimer-electronics>.